

# Geuder®

OPHTHALMIC SURGICAL PRODUCTS



**Geuder®**  
Precision made in Germany

**INSTRUMENTS**

MAIN CATALOGUE

06 / 2018

## FOCUSED ON PRECISION.

### GEUDER - PRECISION MADE IN GERMANY.

GEUDER AG was founded by Hans Geuder Sr. in Heidelberg 1951, since then it has become a worldwide leading manufacturer of ophthalmic surgical instruments and systems as well as provider for highly purified biomaterials. The broad portfolio offered by GEUDER AG includes a wide range of surgical equipment for the anterior and posterior segments of the eye, along with highly innovative biomaterials for retinal and cataract surgery developed and produced by our affiliated company FLUORON GmbH.

As a result of intensive contact and cooperations with leading experts in the ophthalmology world, GEUDER AG is continuously developing and

manufacturing the most innovative products that fulfill the international standards.

A numerous amount of granted patents in more than 65 years demonstrates our intensive involvement in research and development, as well as our forward-looking philosophy. Always keeping our goal to provide the highest level of precision and reliability while complying with the requirements of ophthalmologists to serve the patient's expectations and well being.

With over 3.000 ophthalmic surgical products being distributed in more than 100 countries, GEUDER AG covers a large range of instruments



required for surgical procedures in the anterior and posterior segment of the eye. Thanks to innovative production technologies our instruments offer a unique level of precision and longevity. The constant extension of our product range – particularly single-use instruments – is following the current and especially prospective regulatory requirements and statutory regulations in the medical sector.

Qualified and specialized employees in the field of service and repair ensure that the product's performance and quality is maintained over years – an important feature for the ophthalmic surgeon who is aware of quality and environment.

Our catalogue, in addition to classic standard instruments also displays the most representative current instruments as well as novelties and new developments for innovative surgical methods.

Please contact us for more detailed information about our surgical instruments, systems and biomaterials.

Certified to ISO 9001/13485



	EYE SPECULA	<b>01</b>
	RETRACTORS	<b>02</b>
CALIPERS · MARKERS · MEASURING INSTRUMENTS · TONOMETER · OCULOPRESSOR		<b>03</b>
	CURETTES · SPOONS	<b>04</b>
	FOREIGN BODY INSTRUMENTS	<b>05</b>
	KNIVES · DIAMOND KNIVES	<b>06</b>
	TREPHINES	<b>07</b>
	GLAUCOMA PUNCHES · RONGEURS	<b>08</b>
	SCISSORS	<b>09</b>
	FORCEPS	<b>10</b>
	NEEDLE HOLDERS	<b>11</b>
MANIPULATORS · CHOPPERS · FIXATION RINGS · HOOKS · SPATULAS · LENS LOOPS		<b>12</b>
	SCLERAL DEPRESSORS · LOCALIZERS	<b>13</b>
	PROBES · DILATORS	<b>14</b>
	CANNULAS · I/A INSTRUMENTS	<b>15</b>
	SINGLE USE INSTRUMENTS	<b>16</b>
	MISCELLANEOUS	<b>17</b>
	STERILIZATION CONTAINERS AND ADAPTERS	<b>18</b>
	SETS	<b>19</b>
	INDEX	<b>IN</b>

<b>01.</b>	<b>EYE SPECULA</b> .....	<b>13</b>
	Wire .....	15 – 17
	Wire · Adjustable .....	18 – 19
	Adjustable · Locking .....	20 – 26
	Aspiration · Adjustable · Locking .....	27 – 30
	Glaucoma · Adjustable .....	31
	Glaucoma · Adjustable · Aspiration .....	32
<b>02.</b>	<b>RETRACTORS</b> .....	<b>33</b>
	Lid .....	35 – 36
	Lacrimal Sac .....	37 – 38
	Adjustable .....	38
<b>03.</b>	<b>CALIPERS · MARKERS · MEASURING INSTRUMENTS</b>	
	<b>TONOMETER · OCULOPRESSOR</b> .....	<b>39</b>
	Corneal Markers .....	41 – 42
	Muscle Tucker .....	42
	Calipers .....	43
	Rulers .....	43 – 44
	Trabeculectomy Marker · Strabismus Marker .....	44
	LASIK Markers · Keratometer .....	45
	Degree Gauges · Axis Markers .....	46
	Toric Markers .....	47
	Tonometer · Oculopressor .....	48
<b>04.</b>	<b>CURETTES · SPOONS</b> .....	<b>49</b>
	Chalazion .....	51 – 52
	Enucleation .....	52
<b>05.</b>	<b>FOREIGN BODY INSTRUMENTS</b> .....	<b>53</b>
	Foreign Body Spuds · Needles · Gouges .....	55 – 56
<b>06.</b>	<b>KNIVES · DIAMOND KNIVES</b> .....	<b>57</b>
	Diamond Knives: Paracentesis · Sideport · Universal .....	59
	Diamond Knives: Tri-Facet · Clear Cornea · Trapezoid · Phaco .....	60
	Diamond Knives: Clear Cornea · Crescent · Step Knife · LRI .....	61
	Diamond Knives: Micrometers · Viscocanalostomy · Retinal Surgery .....	62
	Keratome · Chalazion · Viscocanalostomy · Scleral .....	63
	Corneal Scarifier · DMEK Scraper .....	64
	SATO .....	65
	CRVO .....	66

<b>07.</b>	<b>TREPHINES</b> .....	<b>67</b>
	Trephines.....	69 – 70
	Punch.....	70
	Silicone Blocks.....	71 – 72
<b>08.</b>	<b>GLAUCOMA PUNCHES · RONGEURS</b> .....	<b>73</b>
	Rongeurs.....	75
	Glaucoma Punches.....	76 – 77
<b>09.</b>	<b>SCISSORS</b> .....	<b>79</b>
	Corneal · Corneal Section.....	81 – 82
	Stitch.....	82
	Synechia · Trabeculum.....	83
	Capsulotomy.....	83 – 85
	Capsule.....	84 – 86
	Capsulotomy · Rotatable · Interchangeable.....	85
	Capsule (Interchangeable and Rotatable).....	86
	Iris.....	86 – 87
	IOL.....	87 – 88
	Scissors with Needle Holder.....	88
	Tenotomy · Conjunctival · Ring Handle.....	89
	Tenotomy · Strabismus · Ring Handle.....	90
	Utility · Ring Handle.....	91
	Utility · Stitch · Ring Handle.....	92
	Utility · Probe Tips · Ring Handle.....	93
	Utility · Enucleation · Ring Handle.....	94
	Vitreoretinal 20 Gauge.....	95
	Vitreoretinal 23 & 25 Gauge.....	96
	Vitreoretinal (Interchangeable and Rotatable).....	97
<b>10.</b>	<b>FORCEPS</b> .....	<b>99</b>
	Cilia · Foreign Body.....	101
	Conjunctiva.....	102
	Suturing · Fixation.....	103
	Suturing · Colibri Style.....	104
	Corneal Fixation.....	104 – 105
	<i>PAUFIQUE</i> Suturing/Tying.....	105
	Tying.....	106 – 108
	Iris suture · Fragment.....	108
	Jewelers · Fixation.....	109
	Dressing · Tissue.....	110

Iris Fixation .....	110 – 112
Capsulorhexis .....	113 – 117
Capsulorhexis · Micro Incision .....	115
Capsulorhexis · Micro Incision · Interchangeable .....	116
Capsulorhexis · DMEK · Descemetorhexis.....	117
DSAEK.....	118
LASIK Flap .....	118 – 119
Lenticule Extraction .....	119
Nucleus Cracker .....	120
Nucleus Prechoppers .....	120 – 121
IOL Implantation.....	121
IOL Implantation · Silicone Coated.....	122
IOL Implantation · Iris Claw.....	123
IOL Folders .....	123 – 124
IOL Holders.....	124
IOL Explantation .....	125
Superior Rectus .....	126
Muscle .....	126 – 127
Nasal · Retinal.....	127
Retinal (Scleral Plug, Retinal Tack) .....	128
Vitreoretinal (Spreading, Trocar, Foreign Body, Magnet).....	129
Vitreoretinal 20 Gauge .....	130 – 131
Vitreoretinal 23 & 25 Gauge.....	132
Vitreoretinal · Interchangeable · Rotatable .....	133
Chalazion · Ptosis .....	134
Mosquito · Hemostat.....	135
Towel Clamps · Serrefines .....	136
<b>11. NEEDLE HOLDERS .....</b>	<b>137</b>
Needle Holders.....	139 – 144
Needle Holder with Scissors · Intraocular 25 Gauge .....	143
Blade Holders .....	145
<b>12. MANIPULATORS · CHOPPERS · FIXATION RINGS</b>	
<b>HOOKS · SPATULAS · LENS LOOPS.....</b>	<b>147</b>
Fixation Rings .....	149 – 150
Nucleus Choppers .....	151 – 154
Manipulators.....	153 – 154
Nucleus Manipulators.....	155
IOL Manipulators .....	155 – 157
Position Hooks.....	156 – 157
Iris Hooks .....	157 – 158



	Nucleus Fragmentation Spatulas .....	158
	Phaco Spatulas .....	159
	Capsule Polishers .....	160
	Lens Loops .....	161
	Orbital Spatulas .....	162
	Keratoplasty · Synechia Spatulas .....	163
	Cyclodialysis Spatulas .....	164
	Iris Spatulas .....	165 – 166
	Enucleation .....	167
	LASIK Spatulas .....	167 – 168
	DMEK Hooks · DSAEK Glide .....	168
	Femtosecond Cataract .....	169
	Femtosecond LASIK .....	169 – 172
	Strabismus Muscle Tucker .....	172
	Strabismus Hooks .....	173 – 174
	Retinal Detachment Hook .....	174
	Membrane Spatulas · Membrane Peelers .....	175
<b>13.</b>	<b>SCLERAL DEPRESSORS · LOCALIZERS .....</b>	<b>177</b>
	Scleral Depressors .....	179 – 180
	Localizers .....	180
<b>14.</b>	<b>PROBES · DILATORS .....</b>	<b>181</b>
	Lacrimal Probes .....	183 – 186
	Corneal Implant Probes .....	184
	Trabecular Probes · U-Shaped Probe .....	186
<b>15.</b>	<b>CANNULAS · I/A INSTRUMENTS .....</b>	<b>187</b>
	Lacrimal .....	189 – 190
	Lacrimal Probes .....	190
	Retrobulbar · Eye Douche · A.C. Maintainers · Cystotome · Enzyme .....	191
	Hydrodissection · Cyclodialysis .....	192
	Irrigation Vectis · Healon · Trabeculotomy · Sub-Tenon .....	193
	Irrigation .....	194
	Irrigation/Aspiration .....	194 – 195
	Capsule Polishers .....	195 – 196
	LASIK .....	196 – 197
	Irrigation Cannula Handpieces .....	197
	I/A Handpieces · Bimanual .....	198
	Bimanual Irrigation/Aspiration .....	199 – 201
	Irrigation Choppers · Irrigation Hook · Irrigation Scraper .....	202
	Coaxial Irrigation/Aspiration .....	203 – 205

	DMEK Irrigation.....	203
	Coaxial Irrigation/Aspiration.....	204
	Retinal · Backflush Handpieces.....	206
	Retinal · Backflush Cannulas.....	207
	Retinal · Backflush Tips.....	208
	Retinal · Infusion/Injection Cannulas.....	209
	Retinal · Infusion · Aspiration · PFCL.....	210
	Retinal.....	211
	Miscellaneous.....	212
<b>16.</b>	<b>SINGLE USE INSTRUMENTS.....</b>	<b>213</b>
	Manual Trephines · Cutting Block · Non-Vacuum Punches.....	215
	Vacuum Trephines & Punches.....	216
	Surgical Knives.....	217
	Scissors.....	218
	Forceps.....	219
	Endo Probes.....	220
	Trocars.....	221
	Fibre Optics.....	221 – 222
	Vitreous Cutters · Infusion Tube.....	222
	Speculum · DMEK Cartridge · Iris Retractors · Lacrimal Intubation.....	223
	Intubation Sets · Cannulas (Lacrimal, Retrobulbar, Cystotome).....	224
	Cannulas (A.C. Maintainer, Rycroft, Hydrodissection).....	225
	Cannulas (Irrigation Vectis, Capsule Polisher, Simcoe, Viscocanalostomy, Irrigation).....	226
	Bimanual I/A Handpiece · Backflush Handpiece · Backflush Cannula · Silicone Brush.....	227
	Cannulas (Backflush with Silicone Tip, PFCL, Silicone Oil, Infusion).....	228
	Cannulas (Injection, Viscous Fluids, Gas).....	229
	Oil Injection.....	230
	Stopcock · Scalpel Blades · Absorbent Swabs · Marking Pen.....	231
	Silicone Tires.....	232
	Silicone Bands.....	233
	Silicone Strips.....	234
	Silicone Sleeves.....	234 – 235
	Silicone Wedge.....	235
	Silicone Sponge Implants.....	235 – 238
	Bonn Injection Set.....	238
<b>17.</b>	<b>MISCELLANEOUS.....</b>	<b>239</b>
	Injectors (for <i>MORCHER</i> Capsular Tension Ring and Pupil Dilators).....	241
	Lacrimal Instruments · Rongeur · Nasal Speculum · Hammer · Elevatorium · Raspatorium.....	242
	Bone Chisels · LASEK Funnel · Fascia Needle.....	243

	Diamond Burr · Vitrectomy Lenses .....	244
	Eye Shield · Eye Spheres.....	245
	Battery Cautery · Intraocular Magnet.....	246
<b>18.</b>	<b>STERILIZATION CONTAINERS AND ADAPTERS.....</b>	<b>247</b>
	MICROSTOP® .....	249 – 251
	Steel Cases.....	252 – 255
	Trays & Racks for Steel Cases .....	256
	Silicone Strips & Silicone Mats.....	257
	Seals · Small Cases.....	258
	STERISAFE® DURO .....	259 – 262
	STERISAFE® DURO · Melag.....	263
	Adapters .....	264 – 266
<b>19.</b>	<b>SETS .....</b>	<b>S 1</b>
	ECCE – Extra Capsular Cataract Extraction.....	S2
	Phaco / Cataract.....	S3
	Phaco Emergency / MSICS – Manual Small Incision Cataract Surgery.....	S4
	MICS – Micro Incision Cataract Surgery / FLACS – Femtosecond Laser-assisted Cataract Surgery .....	S5
	Snyder-Osher IOL Explantation · Toric IOL · Hattenbach Iris suture .....	S6
	LASEK · LASIK.....	S7
	Femto LASIK · ReLex SMILE.....	S8
	Keratoplasty .....	S9
	DSEK / DSAEK · DALK.....	S10
	DMEK.....	S11
	Glaucoma.....	S12
	Emergency .....	S13
	Enucleation · Pterygium .....	S14
	Office set (Optometrist) · Chalazion .....	S15
	Lid / Ptosis .....	S16
	DCR / Lacrimal.....	S17
	Strabismus / Muscle.....	S18
	Retinal Detachment.....	S19
	Vitrectomy 20G .....	S20 – S21
	Vitrectomy 23G .....	S22 – S23
	Vitrectomy 25G .....	S24
<b>20.</b>	<b>INDEX.....</b>	<b>I 1</b>
	Numerical Index.....	I2 – I9
	Keyword Index .....	I10 – I17
	Name Index.....	I18 – I20

© GEUDER AG

Although every effort has been made to ensure the accuracy of the content presented in this catalogue, GEUDER AG cannot be held liable for any errors that may occur.

Due to the constant technological progress all product specifications and illustrations are subject to change without notice.

No part of this catalogue may be reproduced, edited, copied or disseminated in any form (analog or digital) without prior written consent of GEUDER AG.

All rights reserved by GEUDER AG, Heidelberg, Germany.  
Any violation of the copyright will be prosecuted.

Edition 06/2018

© GEUDER AG

Manufacturer of ophthalmic surgical instruments and systems

Some Geuder products may not be available for sale in certain countries where the products have not yet received investigational, clinical or marketing approval. Please contact your local distributor or GEUDER AG for more information.

GEUDER AG  
Hertzstr. 4  
69126 Heidelberg  
Germany

Phone: +49 6221 306-6  
Fax: +49 6221 303122  
info@geuder.de  
www.geuder.de

„NanoEdge®“, „UNO Colorline®“, „Densiron®“, „Megatron®“, „endoTRON®“ and „MACH2“ are registered trademarks of Geuder AG.

„EasyGas®“ is a registered trademark of Fluoron GmbH.

„Sterisafe®“ is a registered trademark of SAVUNA GmbH & Co. KG.

„microStop®“ is a registered trademark of Gebrüder Martin GmbH & Co. KG.

„ReLEx® Smile“ and „SMILE“ are registered trademarks of Carl Zeiss Meditec AG.

„IRIDEX®“ is a registered trademark of IRIDEX Corporation.

„ACCURUS®“ is a registered trademark of Alcon Laboratories, Inc.

„Pentasy®“ is a registered trademark of Fritz RUCK Ophthalmologische Systeme GmbH.

„Millennium®“ is a registered trademark of MBI Millennium Biomedical, Inc.

## EYE SPECULA



WIRE .....	15
WIRE AND ADJUSTABLE .....	18
ADJUSTABLE / LOCKING .....	20
WITH ASPIRATION .....	27
ADJUSTABLE / BLADE ELEVATION .....	31



**G-17020** *BARRAQUER*  
**EYE SPECULUM**  
fenestrated  
14 mm blades  
overall length 38 mm



**G-17025** *BARRAQUER*  
**EYE SPECULUM**  
for infants  
fenestrated  
10 mm blades  
overall length 40 mm



**G-17023** *BARRAQUER*  
**EYE SPECULUM**  
for premature infants  
fenestrated  
7 mm blades  
overall length 34 mm

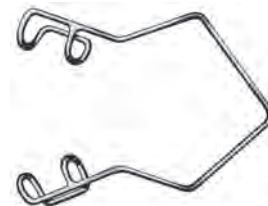

**G-17026** *BARRAQUER*  
**EYE SPECULUM**  
15 mm solid blades  
overall length 40 mm



01

WIRE

01

WIRE

G-32136

*BARRAQUER*  
**EYE SPECULUM**  
 fenestrated  
 14 mm round blades  
 overall length 38 mm

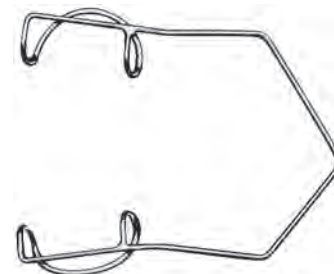

G-32137

*BARRAQUER*  
**EYE SPECULUM**  
 for infants  
 fenestrated  
 10 mm round blades  
 overall length 38 mm

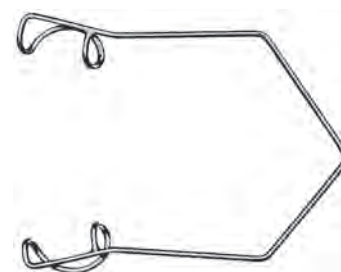

G-32148

*BARRAQUER*  
**EYE SPECULUM**  
 fenestrated  
 14.5 mm open blades  
 overall length 40 mm

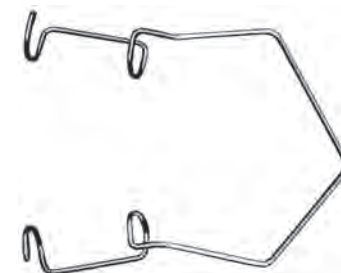

G-32149

*BARRAQUER FRANKFURT MODEL*  
**EYE SPECULUM**  
 fenestrated, large  
 14.5 mm blades  
 overall length 40 mm

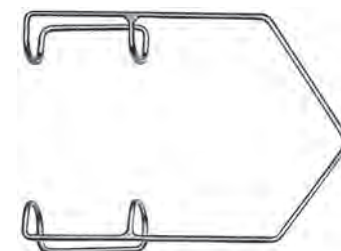



G-32133

*KRATZ-BARRAQUER***EYE SPECULUM**

fenestrated  
15 mm round wing blades  
overall length 40 mm

to lift and retract the lids away from the globe  
eliminating external pressure

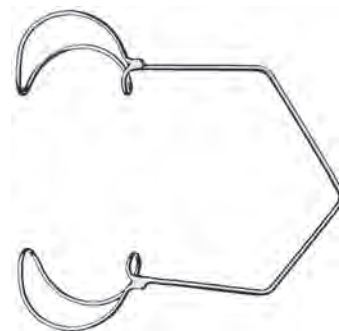

01

WIRE

*OHNO***EYE SPECULUM**

fenestrated  
14 mm round blades  
overall length 45 mm  
middle bar controls redundant lid tissue  
for the right eye  
for the left eye

G-32126

G-32127

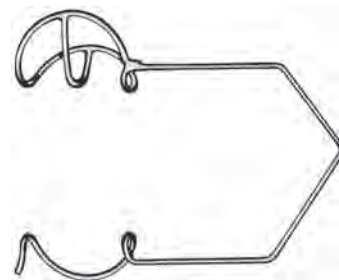

G-17004

*H.-R. KOCH***TEMPORAL APPROACH EYE SPECULUM**

for nasal placement  
fenestrated  
14 mm open blades  
overall length 40 mm

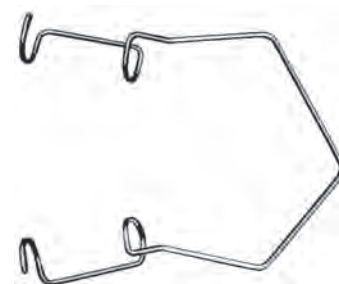

G-32129

**TEMPORAL APPROACH EYE SPECULUM**

for nasal placement  
fenestrated  
15 mm round blades  
overall length 40 mm

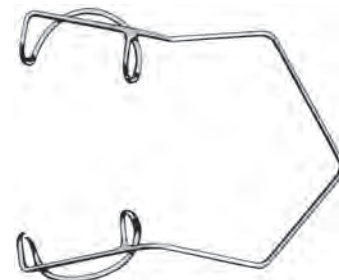

01

WIRE · ADJUSTABLE

*BARRAQUER-OOSTERHUIS*

**EYE SPECULUM**

fenestrated, adjustable

**G-17010**

14 mm blades, overall length 40 mm

**G-17011**

10 mm blades, overall length 30 mm, for infants

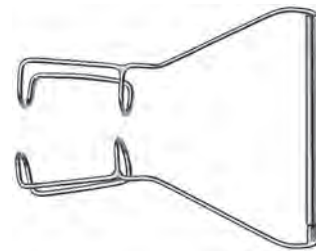

*BARRAQUER-OOSTERHUIS*

**EYE SPECULUM**

solid blades, adjustable

**G-17015**

15 mm blades, overall length 40 mm

**G-17016**

11 mm blades, overall length 30 mm, for infants

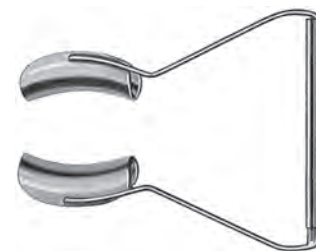

*BARRAQUER-OOSTERHUIS*

**EYE SPECULUM**

fenestrated round blades

adjustable

**G-32138**

14 mm blades, overall length 40 mm

**G-32139**

11 mm blades, overall length 30 mm, for infants

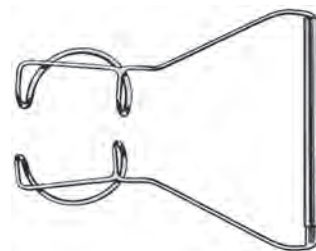

**G-17017**

*BARRAQUER-OOSTERHUIS-KRATZ*

**EYE SPECULUM**

adjustable, fenestrated

15 mm open blades

overall length 40 mm

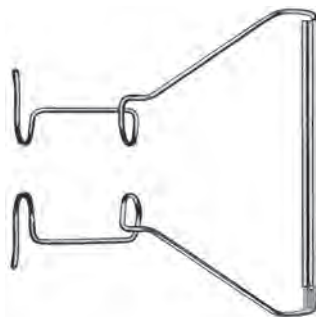

- G-32119** *KRATZ-BARRAQUER*  
**EYE SPECULUM**  
adjustable, fenestrated  
15 mm round wing blades  
overall length 40 mm

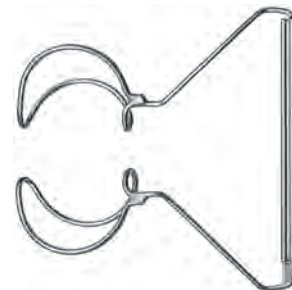

01

WIRE · ADJUSTABLE

- G-17027** *THOMAS NEUHANN*  
**EYE SPECULUM**  
adjustable  
15 mm solid blades  
overall length 40 mm

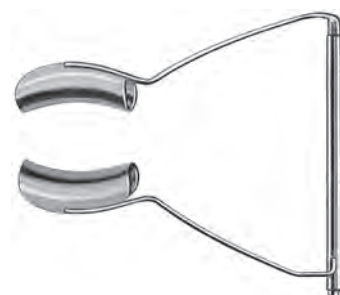

- G-17030** *SAUER*  
**EYE SPECULUM**  
12 mm solid blades  
overall length 30 mm



- G-32134** *TAKEDA*  
**EYE SPECULUM**  
for infants  
9 mm fenestrated blades  
with finger grips and  
angled interlacing valves  
overall length 28 mm

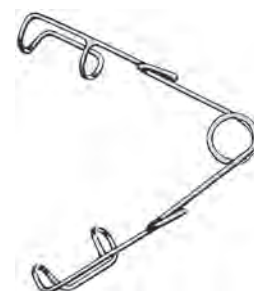

G-15945

*MELLINGER*  
**EYE SPECULUM**

large  
adjustable, self retaining  
16.5 mm fenestrated blades  
overall length 65 mm

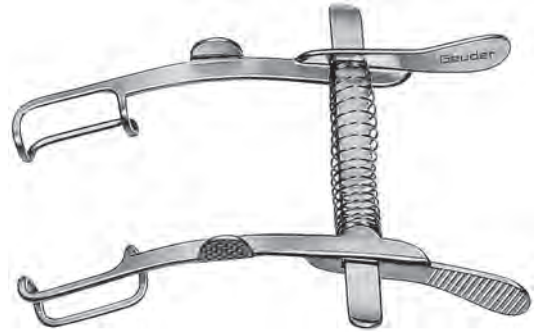

G-32130

*MELLINGER*  
**EYE SPECULUM**

small, for infants  
adjustable, self retaining  
12.5 mm fenestrated blades  
overall length 55 mm

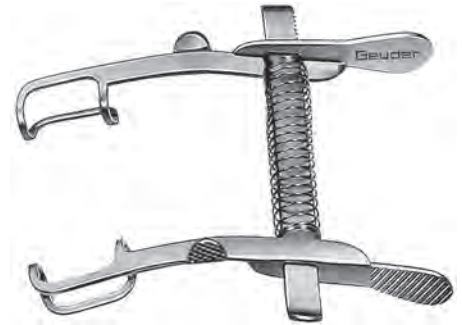

G-15946

*MELLINGER-BEARD*  
**EYE SPECULUM**

large  
adjustable, self retaining  
15.5 mm solid blades  
overall length 65 mm

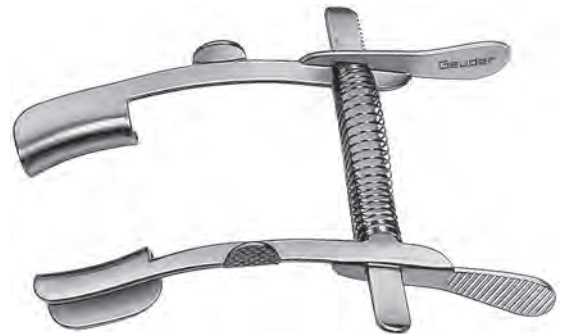

G-32135

*MELLINGER-BEARD*  
**EYE SPECULUM**

small, for infants  
adjustable, self retaining  
11.5 mm solid blades  
overall length 55 mm

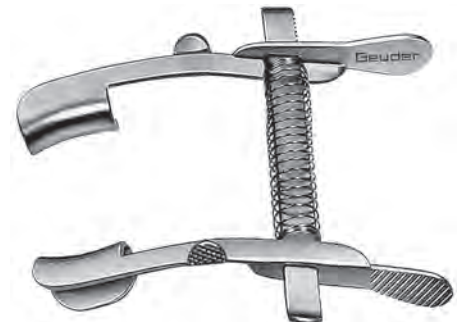

*PRETORI***EYE SPECULUM**

13.5 mm fenestrated blades  
adjustable, self retaining  
overall length 63 mm  
left  
right

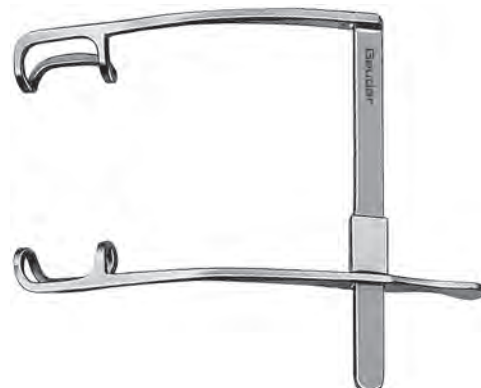
**G-16050****G-16055****G-15950***WEISS***EYE SPECULUM**

fenestrated  
adjustable with locking screw  
17.5 mm blades  
overall length 85 mm

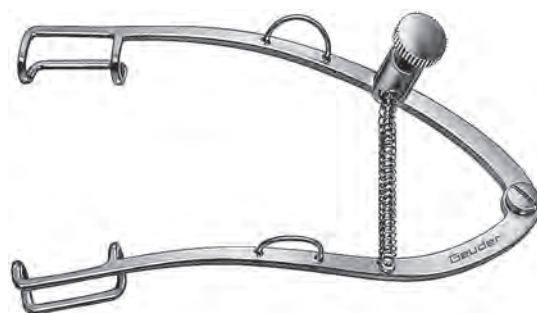
**G-15951***WEISS***EYE SPECULUM**

fenestrated  
adjustable with locking screw  
17.5 mm open blades  
overall length 85 mm

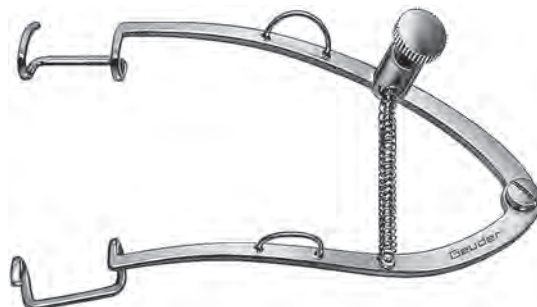
**G-15955***WEISS***EYE SPECULUM**

small  
adjustable with locking screw  
15 mm fenestrated blades  
overall length 55 mm



G-15956

*WEISS*  
**EYE SPECULUM**

small  
adjustable with locking screw  
15 mm open blades  
overall length 55 mm



G-15970

*WEISS*  
**EYE SPECULUM**

adjustable with locking screw  
16.5 mm solid blades  
overall length 85 mm



G-15975

*WEISS*  
**EYE SPECULUM**

small  
adjustable with locking screw  
14 mm solid blades  
overall length 55 mm

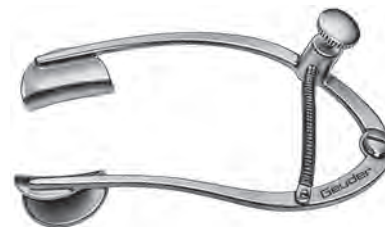

G-37130

*BARTL*  
**EYE SPECULUM**

adjustable  
with silicone band to secure vitrectomy lens  
15 mm solid blades  
overall length 39 mm



- G-16010** *BANGERTER*  
**EYE SPECULUM**  
adjustable, with locking screw  
15 mm solid blades  
overall length 52 mm

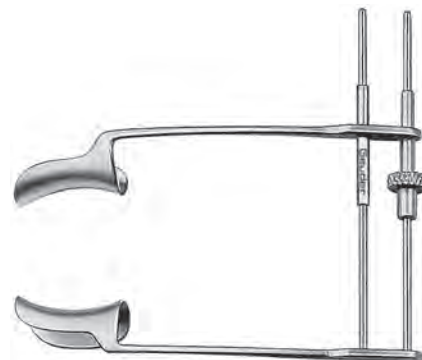

- CASTROVIEJO*  
**EYE SPECULUM**  
fenestrated, adjustable  
overall length 96 mm  
**G-16020** 14 mm blades, small  
**G-16025** 16 mm blades, medium  
**G-16030** 18 mm blades, large



- G-15990** *COOK*  
**EYE SPECULUM**  
large  
16 mm solid blades  
adjustable, with locking screw  
overall length 50 mm

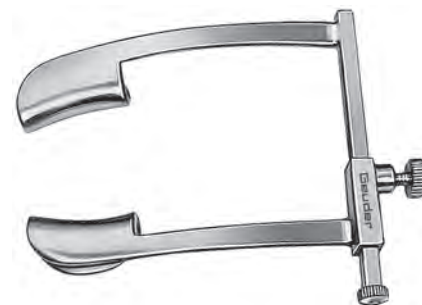

- G-15995** *COOK*  
**EYE SPECULUM**  
medium  
11 mm solid blades  
adjustable, with locking screw  
overall length 40 mm



01

ADJUSTABLE · LOCKING

01

ADJUSTABLE · LOCKING

G-16000

*COOK*  
**EYE SPECULUM**

small  
8 mm solid blades  
adjustable, with locking screw  
overall length 35 mm



G-32128

*COOK*  
**EYE SPECULUM**

for infants  
5 mm solid blades  
adjustable, with locking screw  
overall length 30 mm



G-17000

*MURDOCK*  
**EYE SPECULUM**

left  
14 mm fenestrated blades  
adjustable, self retaining  
overall length 50 mm

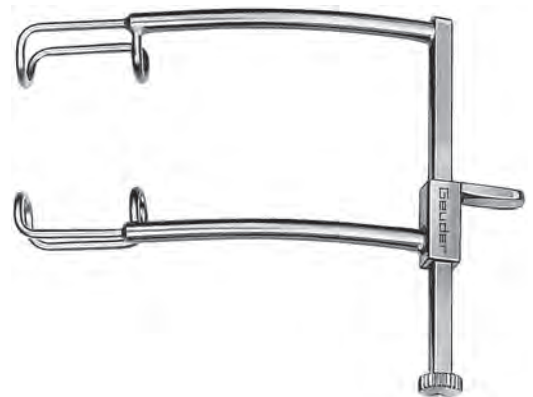

G-17001

*MURDOCK*  
**EYE SPECULUM**

right  
14 mm fenestrated blades  
adjustable, self retaining  
overall length 50 mm

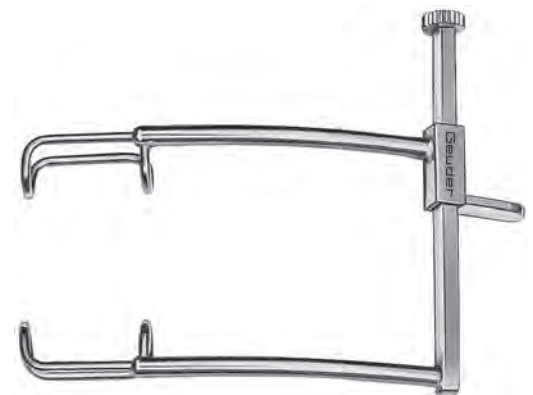



*MURDOCK*  
**EYE SPECULUM**

small  
12 mm fenestrated blades  
adjustable, self retaining  
overall length 45 mm  
left  
right

**G-17002**  
**G-17003**

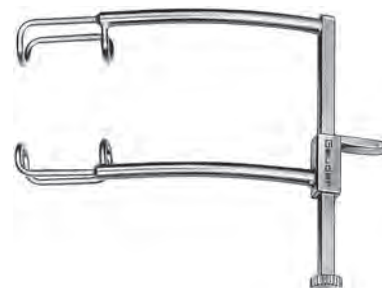

01

ADJUSTABLE · LOCKING

**G-15960***LIEBERMANN-TENNANT*  
**EYE SPECULUM**

adjustable, fenestrated  
for temporal placement  
15 mm open blades  
overall length 80 mm

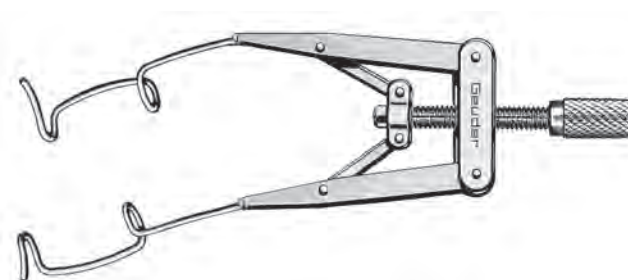
**G-15965***KERSHNER*  
**EYE SPECULUM**

adjustable, reversible  
for nasal and temporal placement  
15 mm fenestrated blades  
overall length 75 mm

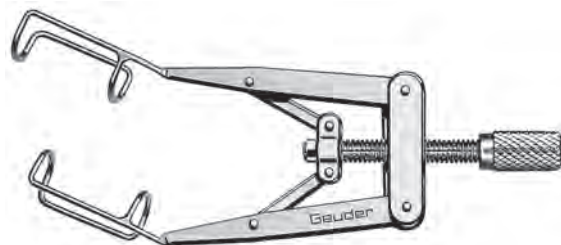
**G-15966***KERSHNER*  
**EYE SPECULUM**

adjustable, reversible  
for nasal and temporal placement  
15 mm solid blades  
overall length 75 mm

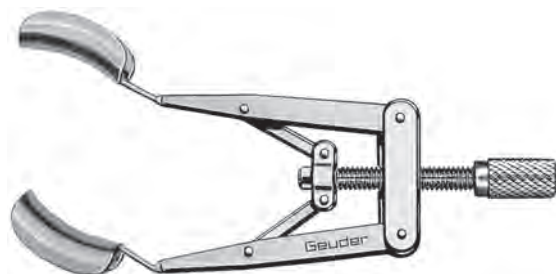

G-33965

*DICK*  
**FEMTOCATARACT EYE SPECULUM**

adjustable  
18 mm flattened fenestrated blades with middle bar to control redundant lid tissue  
overall length 80 mm

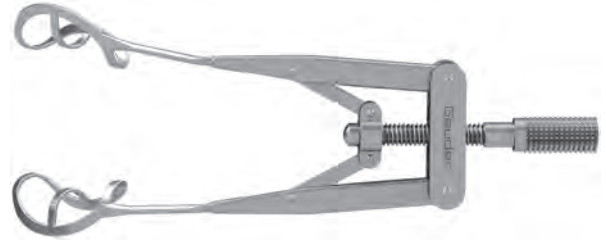

G-33971

*SOLOMON*  
**FEMTOCATARACT EYE SPECULUM**

14.5 mm flattened fenestrated blades with middle bar to control redundant lid tissue  
double knurled screw for fast adjustment and fine tuning  
overall length 90 mm



G-33919

**SPARE TUBING SET**  
for eye speculum with aspiration

1/2

G-33920

*KNORZ*  
**LASIK EYE SPECULUM**

adjustable, with aspiration  
16 mm fenestrated blades  
to remove excess fluid from the surgical field  
supplied with silicone tubing and adaptor

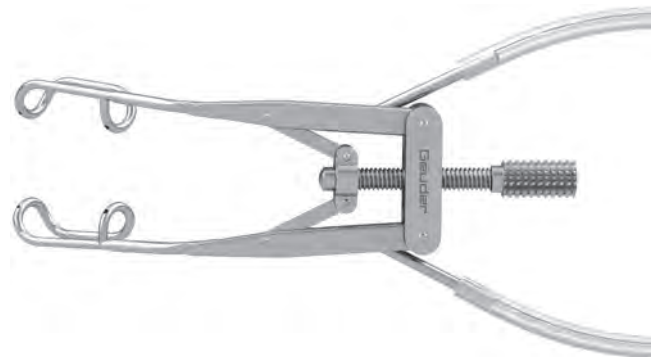

*NODA***EYE SPECULUM**

adjustable, with aspiration  
to remove excess fluid from the surgical field  
supplied with silicone tubing and adaptor

**G-17019**

15 mm open blades

**G-17021**

12 mm open blades, for infants

**G-17005***PAULMANN***EYE SPECULUM**

adjustable, with aspiration  
for PPV, with extra aspiration bar  
16 mm fenestrated blades  
to remove excess fluid from the surgical field  
supplied with silicone tubing and adaptor

**G-17006****CLAMP FOR INFUSION TUBE**for *PAULMANN* eye speculum (G-17005)

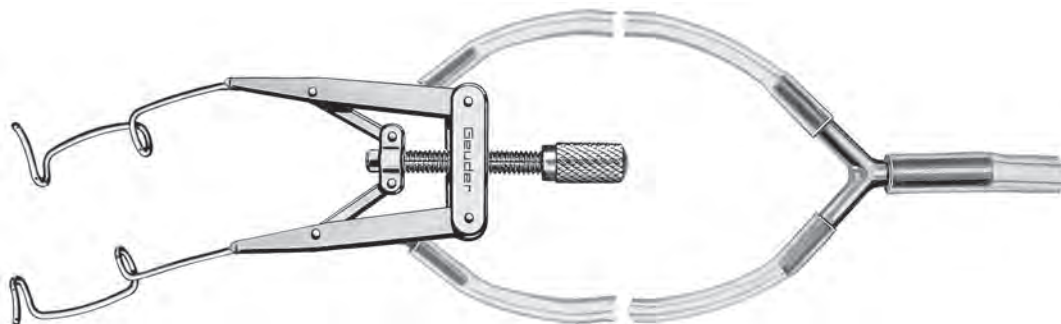

**G-15961**

*LIEBERMANN-TENNANT*  
**EYE SPECULUM**

adjustable, with aspiration  
for temporal placement  
15 mm open blades  
overall length 80 mm  
to remove excess fluid from the surgical field  
supplied with silicone tubing and adaptor



**G-17024**

*KOGA / NODA*  
**EYE SPECULUM**

with 5 mm aspiration slits  
adjustable  
12 mm open blades  
to remove excess fluid from the surgical field  
supplied with silicone tubing and adaptor



G-17031

NODA

**EYE SPECULUM**

adjustable, with aspiration  
open blades  
2 x 10 aspiration ports  
supplied with silicone tubing and adaptor

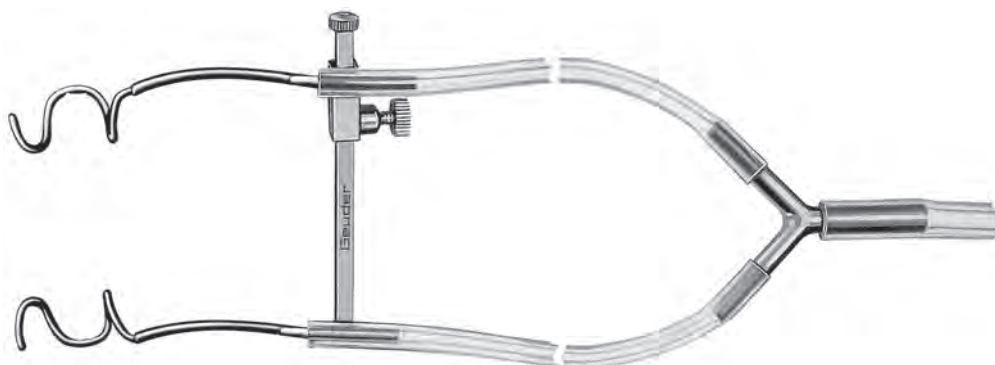

G-15962

KAMMANN

**EYE SPECULUM**

adjustable, with aspiration  
self retaining  
11 mm fenestrated blades  
to remove excess fluid from the surgical field  
supplied with silicone tubing and adaptor

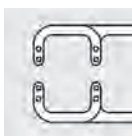



G-33914

*ZIRM***LASIK EYE SPECULUM**

adjustable, with aspiration  
 16 mm fenestrated blades  
 to remove excess fluid from the surgical field  
 supplied with silicone tubing and adaptor

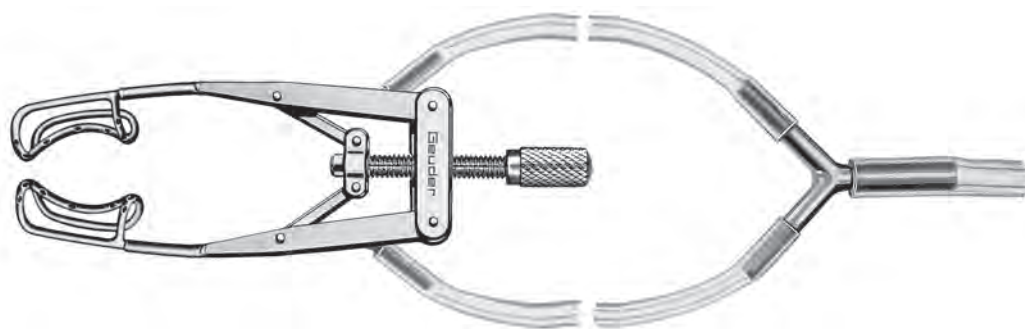

G-33925

*MAUS***LASIK EYE SPECULUM**

adjustable, with middle aspiration bar  
 16 mm fenestrated blades  
 to remove excess fluid from the surgical field  
 supplied with silicone tubing and adaptor

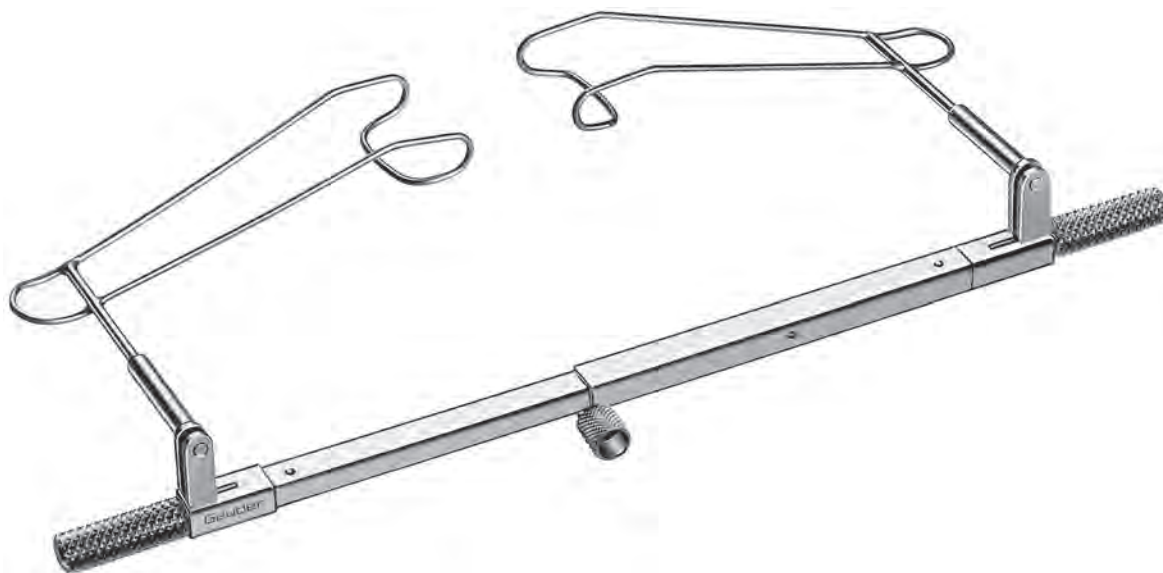
**EYE SPECULUM**

fenestrated blades  
adjustable mechanism regulates opening and blade elevation  
optimal for glaucoma surgery

**G-15920**

large, 16 mm blades

**G-15925**

small, 12 mm blades

*SCHOTT***EYE SPECULUM**

solid blades  
adjustable mechanism regulates opening and blade elevation  
optimal for glaucoma surgery

**G-15921**

large, 15 mm blades

**G-15926**

small, 11 mm blades

01

GLAUCOMA · ADJUSTABLE · ASPIRATION

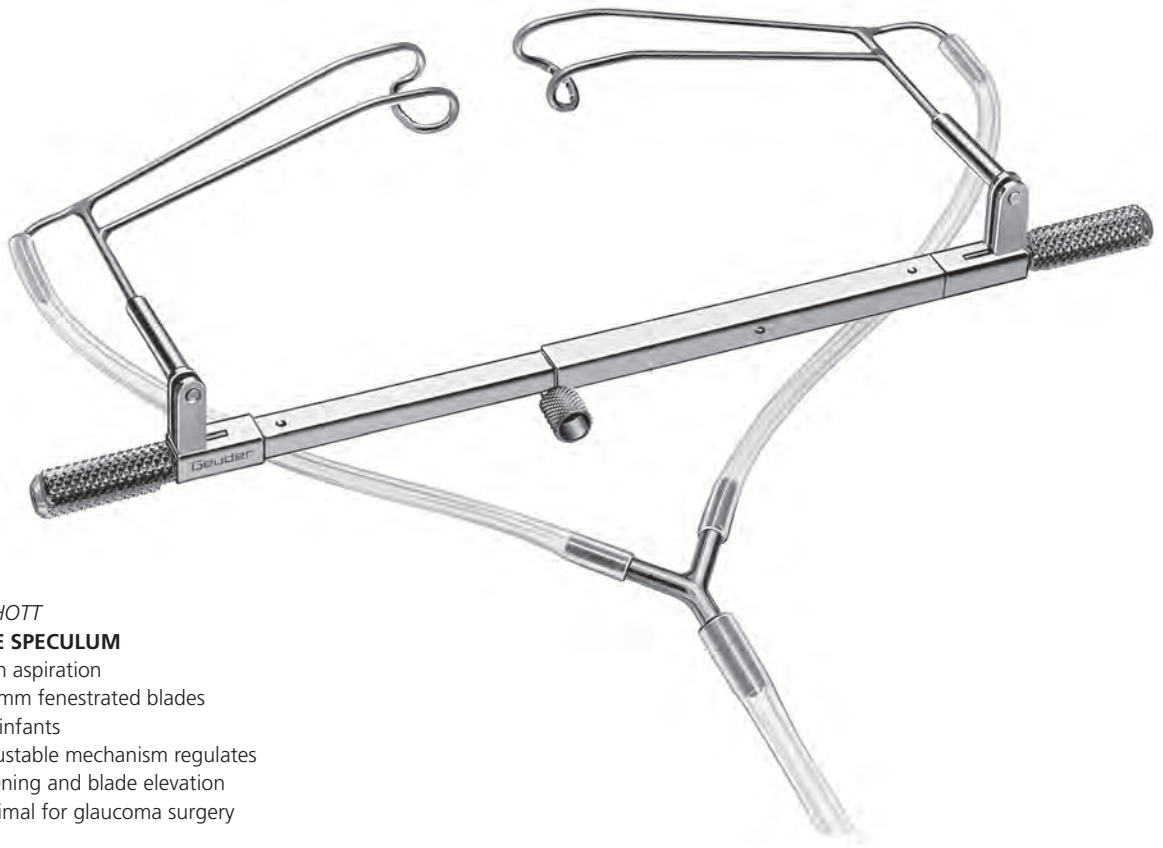

**G-15928**

*SCHOTT*  
**EYE SPECULUM**

with aspiration  
13 mm fenestrated blades  
for infants  
adjustable mechanism regulates  
opening and blade elevation  
optimal for glaucoma surgery



## RETRACTORS







**G-16080** *DESMARRES*  
**LID RETRACTOR**  
for infants  
7 mm wide  
overall length 133 mm



**G-32120** *DESMARRES*  
**LID RETRACTOR**  
fig. 0  
9 mm wide  
overall length 138 mm



**G-16060** *DESMARRES*  
**LID RETRACTOR**  
fig. 1  
12 mm wide  
overall length 133 mm



**G-16065** *DESMARRES*  
**LID RETRACTOR**  
fig. 2  
14 mm wide  
overall length 135 mm



**G-16070** *DESMARRES*  
**LID RETRACTOR**  
 fig. 3  
 16 mm wide  
 overall length 138 mm



**G-16075** *DESMARRES*  
**LID RETRACTOR**  
 fig. 4  
 17 mm wide  
 overall length 138 mm



**G-32115** *GIESSEN MODEL*  
**LID RETRACTOR**  
 14 mm wide, fenestrated  
 overall length 133 mm



**G-17040** *JAEGER*  
**LID PLATE**  
 stainless steel  
 20 mm and 23 mm concave ends  
 overall length 110 mm



**G-15542** *AXENFELD*  
**LACRIMAL SAC RETRACTOR**  
4 prongs, blunt  
9 mm wide  
overall length 140 mm



*AXENFELD*  
**LACRIMAL SAC RETRACTOR**  
3 prongs, 7 mm wide  
overall length 140 mm  
**G-15540** blunt  
**G-15545** sharp



*AXENFELD*  
**LACRIMAL SAC RETRACTOR**  
2 prongs, 4 mm wide  
overall length 140 mm  
**G-15550** blunt  
**G-15555** sharp



**G-15560** *ROLLET*  
**LACRIMAL SAC RETRACTOR**  
4 prongs, sharp  
6 mm wide  
overall length 140 mm

02  
LACRIMAL SAC



*GUTHRIE*  
**RETRACTOR**  
 double skin hook, sharp  
 overall length 125 mm  
 small  
**G-15350**  
 large  
**G-15355**



**G-17085**  
*AMERICAN MODEL*  
**LACRIMAL SAC RETRACTOR**  
 4 x 4 prongs, blunt  
 cross-action  
 adjustable, self retaining  
 overall length 100 mm

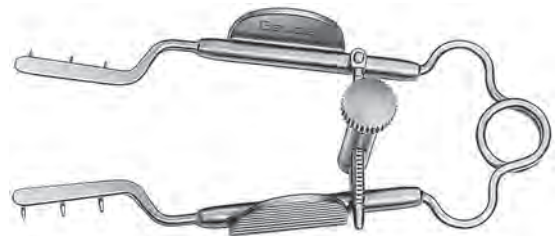

**G-17070**  
*MUELLER*  
**LACRIMAL SAC RETRACTOR**  
 3 x 3 prongs  
 adjustable  
 overall length 70 mm

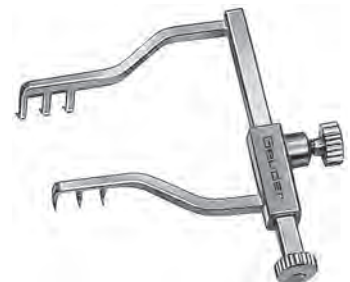

**G-17080**  
*GOLDSTEIN*  
**LACRIMAL SAC RETRACTOR**  
 3 x 3 prongs  
 adjustable  
 overall length 30 mm

## CALIPERS, MARKERS MEASURING INSTRUMENTS TONOMETER, OCULOPRESSOR



CORNEAL MARKERS.....	<b>41</b>
CORNEAL MARKERS · MUSCLE TUCKER.....	<b>42</b>
CALIPERS · RULERS.....	<b>43</b>
RULERS · TRABECULECTOMY MARKER · STRABISMUS MARKER.....	<b>44</b>
LASIK MARKERS · KERATOMETER.....	<b>45</b>
DEGREE GAUGES · AXIS MARKERS.....	<b>46</b>
TORIC MARKERS.....	<b>47</b>
TONOMETER · OCULOPRESSOR.....	<b>48</b>







*THOMAS NEUHANN*  
**CORNEAL MARKER**  
with cross hairs  
inside diameter 3.0 mm  
outside diameter 12.0 mm  
overall length 105 mm

- G-33725** 4 blades
- G-33726** 6 blades
- G-33727** 8 blades



**G-32222** *THOMAS NEUHANN*  
**CORNEAL MARKER**  
for astigmatic keratotomy  
10° scale and cross-hairs  
6.0 mm inside diameter  
8.0 mm outside diameter  
overall length 105 mm

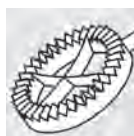

*HOFFER*  
**CORNEAL MARKER**  
for optic zone  
with cross hairs  
overall length 103 mm  
**G-33740** inside diameter 7.0 mm  
**G-33741** inside diameter 7.5 mm  
**G-33742** inside diameter 8.0 mm



**G-38600** *THOMAS NEUHANN*  
**CORNEAL MARKER**  
for DSAEK/DSEK/DMEK procedures  
combination of 8.0 mm / 9.0 mm diameters  
to produce a guide for Descemetorhexis  
overall length 123 mm





LINDSTROM

**CORNEAL MARKER**

to mark arcuate incisions  
for surgical correction of astigmatism  
overall length 100 mm  
optic zone 6.0 mm  
G-33780  
G-33781



DUNCKER

**SUTURE MARKER**

8-pointed star and cross hairs  
to center the trephine and perform  
double running suture  
overall length 102 mm  
for 7.0 mm transplant  
G-32228  
G-32229



G-32224

THOMAS NEUHANN

**SUTURE MARKER**

8 blades  
for keratoplasty  
fits with KRUMEICH GTS  
overall length 102 mm



G-19137

CUEPPERS

**STRABISMUS MUSCLE TUCKER**

15 mm scale  
serrated J-shaped hook to  
prevent the muscle from slipping

*CASTROVIEJO*

**CALIPER**

scale on both sides  
with 1 mm increments

**G-19130** 15 mm scale, overall length 78 mm

**G-19135** 20 mm scale, overall length 85 mm



**G-19138**

*OSHER*

**INCISION MEASURING CALIPER**

1 to 10 mm  
scale on both sides  
for internal measurement of cataract incisions  
overall length 75 mm

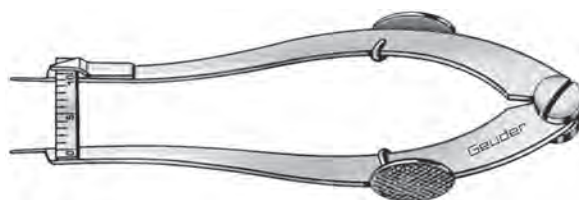

**G-37400**

*BRAUNSTEIN*

**FIXED CALIPER**

for marking of sclerotomy site  
at 3.5 mm posterior to the surgical limbus  
overall length 45 mm



**G-37410**

*BRAUNSTEIN*

**FIXED CALIPER**

for marking of sclerotomy site posterior  
to the surgical limbus  
overall length 80 mm

**G-37410** 3.0 mm / 3.5 mm

**G-37412** 3.0 mm / 4.0 mm

**G-37414** 3.5 mm / 4.0 mm

**G-37418** 4.0 mm / 5.0 mm

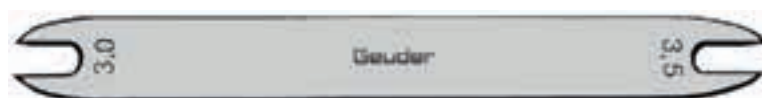

**G-18650**

**RULER**

150 mm

0.5 mm and 1.0 mm increments

**G-18645** *GIESSEN MODEL*  
**RULER**  
vaulted  
1 to 30 mm  
overall length 60 mm



**G-32225** *VOGT*  
**SCLERAL RULER**  
vaulted  
1 to 20 mm  
overall length 126 mm



**G-32004** *ENGELS*  
**MEASURING SPATULA**  
1 to 15 mm  
angled 45°  
overall length 88 mm



**G-32210** *FRONIMOPOULUS*  
**TRABECULECTOMY MARKER**  
5 x 5 mm  
U-shaped marking pattern  
overall length 70 mm



**G-32209** *TOBIAS NEUHANN*  
**SCLERAL FLAP MARKER**  
5.0 mm and 4.0 mm  
U-shaped marking patterns  
swivel handle allows marking from temporal  
or superior approach



**G-15797** *FINK*  
**STRABISMUS MARKER**  
1 mm criss-cross marking tips  
for accurate 9 mm recession of the  
inferior oblique muscle  
overall length 87 mm



**G-33785**

*GRENE*  
**VISUAL AXIS MARKER**  
0.5 mm diameter  
concave tip  
overall length 103 mm



**G-33745**

*MENDEZ*  
**LASIK CORNEAL MARKER**  
for lamellar flap identification  
and realignment  
overall length 105 mm

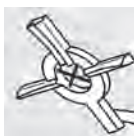

**G-33746**

*CHAYET*  
**LASIK CORNEAL MARKER**  
for lamellar flap identification  
and realignment  
overall length 105 mm



**G-33747**

*LU*  
**LASIK CORNEAL MARKER**  
for lamellar flap identification  
and realignment  
overall length 105 mm



**G-32318**

*MALONEY*  
**KERATOMETER**  
for qualitative measurement of astigmatism  
overall length 20 mm



**03**

LASIK MARKERS · KERATOMETER

G-33760

MENDEZ

**DEGREE GAUGE**

measures from 0° to 180°  
5° increments  
12 mm inside diameter  
overall length 110 mm



G-33762

**DEGREE GAUGE**

for toric IOLs  
with 5° increments and  
rotating alignment rings  
12 mm inside diameter  
overall length 110 mm



G-33763

GERTEN

**HORIZONTAL AXIS MARKER**

for precise marking of the 0° axis  
during toric IOL implantation  
or refractive laser surgery  
overall length 105 mm



G-33774

SCOTT

**CORNEAL PENDULUM MARKER**

for temporary placement of  
0°, 90°, and 180° pre-op toric marks  
self-leveling pendulum assures precise  
horizontal axis  
overall length 110 mm



**G-33777**

**TOMARK  
ADJUSTABLE CORNEAL MARKER**

to mark the axis of astigmatism during toric IOL placement  
0° to 180° degree gauge  
5° increments  
overall length 32 mm



for use in combination with slit lamp or G-33776

**03**

TORIC MARKERS



**G-33776**

**TOMARK PENDULUM INSTRUMENT**

self-leveling handheld pendulum assures precise  
horizontal axis  
overall length 140 mm

to retain TOMARK corneal marker G-33777

**G-33778**

**RETAINER FOR PENDULUM INSTRUMENT**

for G-33776 TOMARK  
overall length 180 mm

1/2



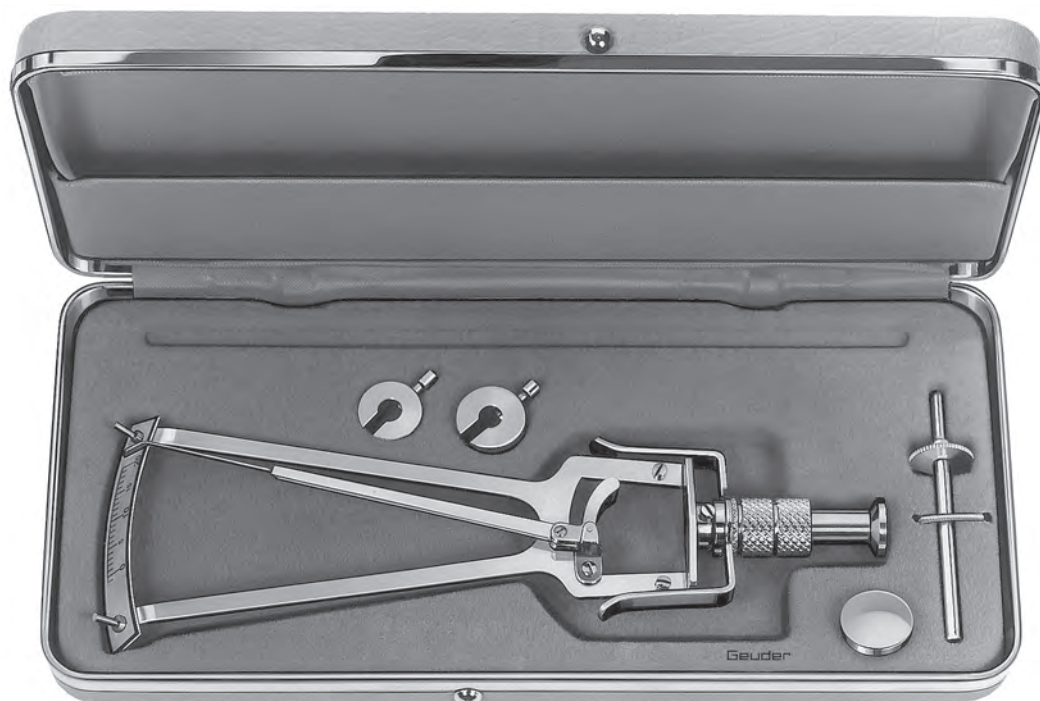

**G-19230**     *SCHIOETZ*  
**TONOMETER**  
with two weights of 7.5 g and 10 g

**G-15392**     *HOMBURG MODEL*  
**OCULOPRESSOR**

**G-15393**     **SILICONE BALL**  
with band, for Oculopressor  
*HOMBURG MODEL G-15392*





## CURETTES SPOONS







**G-15900** *MEYHOEFER*  
**CHALAZION CURETTE**  
1.0 mm diameter cup  
overall length 129 mm



**G-15870** *MEYHOEFER*  
**CHALAZION CURETTE**  
2.0 mm diameter cup  
overall length 129 mm



**G-15875** *MEYHOEFER*  
**CHALAZION CURETTE**  
2.5 mm diameter cup  
overall length 129 mm



**G-15880** *MEYHOEFER*  
**CHALAZION CURETTE**  
3.0 mm diameter cup  
overall length 129 mm



**G-15885** *MEYHOEFER*  
**CHALAZION CURETTE**  
4.0 mm diameter cup  
overall length 129 mm

04

CHALAZION



**G-15840** *HEBRA*  
**CHALAZION CURETTE**  
 small  
 2.5 mm x 4.0 mm oval scoop  
 overall length 133 mm



**G-15845** *HEBRA*  
**CHALAZION CURETTE**  
 medium  
 3 mm x 5 mm oval scoop  
 overall length 133 mm

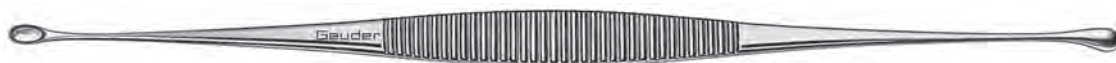

**G-15910** *AXENFELD*  
**CHALAZION CURETTE**  
 double ended  
 4.5 x 2.5 mm and 6.5 x 3.0 mm oval currettes  
 overall length 144 mm



**G-31545** *BUNGE*  
**EXENTERATION CURETTE**  
 medium  
 10 mm spoon  
 overall length 142 mm



**G-31555** *BUNGE*  
**EXENTERATION CURETTE**  
 large  
 12 mm spoon  
 overall length 144 mm

04

CHALAZION · ENUCLEATION

## FOREIGN BODY INSTRUMENTS







**G-14550 FOREIGN BODY INSTRUMENT**  
double-ended with sliding handle  
2.2 mm wide curved needle  
1 mm wide *PLANGE* spud  
overall length 95 mm



**G-14540 FOREIGN BODY INSTRUMENT**  
double ended with sliding handle  
2.2 mm wide curved needle  
1.4 mm wide gouge  
overall length 95 mm



**G-14530 FOREIGN BODY INSTRUMENT**  
double ended with sliding handle  
2.2 mm wide curved needle  
1.4 mm wide spud  
overall length 95 mm

**G-14490**

**FOREIGN BODY NEEDLE**

straight  
4.5 mm long triangular tip  
2.4 mm wide  
overall length 120 mm



**G-14500**

**FOREIGN BODY NEEDLE**

curved  
4.5 mm long triangular tip  
2.4 mm wide  
overall length 120 mm



**G-14570**

*PLANGE*  
**FOREIGN BODY SPUD**

curved and rounded  
1 mm wide spud  
overall length 125 mm



**G-14480**

**FOREIGN BODY GOUGE**

straight  
1.4 mm wide gouge  
overall length 116 mm





## KNIVES DIAMOND KNIVES



PARACENTESIS · SIDEPORT · UNIVERSAL .....	<b>59</b>
TRIFACET · CLEAR CORNEA .....	<b>60</b>
CRESCENT · STEP TRIFACET · LRI .....	<b>61</b>
MICROMETER · VISCOCANALOSTOMY · RETINAL SURGERY .....	<b>62</b>
KERATOME · CHALAZION · SCLERAL .....	<b>63</b>
CORNEAL SCARIFIER · DMEK SCRAPER .....	<b>64</b>
SATO .....	<b>65</b>
CRVO .....	<b>66</b>





**G-38475 DIACLEAN DIAMOND KNIFE**

for paracentesis  
1 mm wide spear  
titanium handle  
width 1.0 mm  
length 4.0 mm  
thickness 0.2 mm

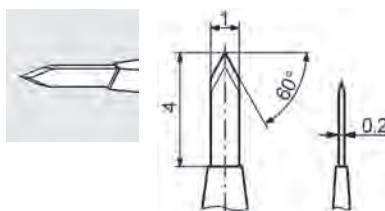

**G-38344 DIACLEAN DIAMOND KNIFE**

1 mm wide, 45° diamond blade  
titanium handle  
width 1.0 mm  
length 3.0 mm  
thickness 0.2 mm

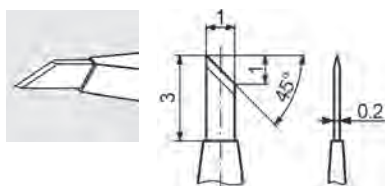

**G-38341 DIACLEAN DIAMOND KNIFE**

60° spear diamond blade  
titanium handle  
width 1.4 mm  
length 3.0 mm  
thickness 0.2 mm

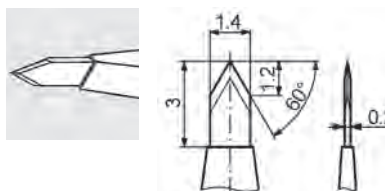

**G-38343 DIACLEAN DIAMOND KNIFE**

45° spear diamond blade  
titanium handle  
width 1.4 mm  
length 3.0 mm  
thickness 0.2 mm

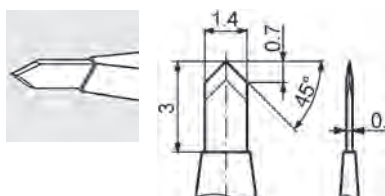



**G-38342 DIACLEAN TRI-FACET DIAMOND KNIFE**

1 mm wide tri-facet diamond blade  
 titanium handle  
 width 1.0 mm  
 length 3.0 mm  
 thickness 0.2 mm

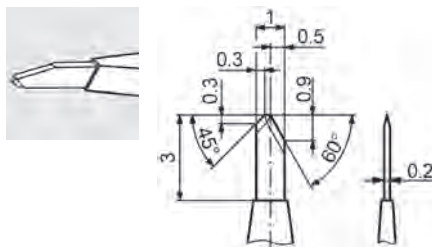

06



**G-38473 PHAM DIACLEAN TRI-FACET DIAMOND KNIFE**

titanium handle  
 width 1.5 mm  
 length 3.0 mm  
 thickness 0.2 mm

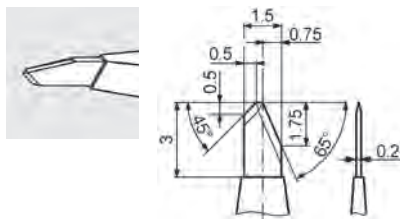

DIAMOND KNIVES: TRI-FACET · CLEAR CORNEA · TRAPEZOID · PHACO



**G-38448 DIACLEAN CLEAR-CORNEA-INCISION DIAMOND KNIFE, 1.5/2.0 mm**

MICS trapezoid blade, 35° angled  
 4 cutting edges  
 titanium handle  
 width 1.5 / 2.0 mm  
 length 5.0 mm  
 thickness 0.2 mm

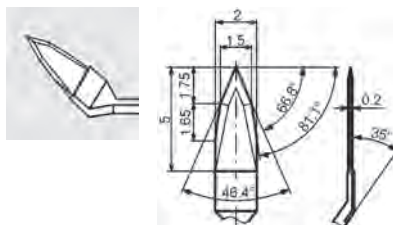

**G-38444 DIACLEAN CLEAR-CORNEA-INCISION DIAMOND KNIFE, 2.2 MM**

4 cutting edges, 35° angled  
 titanium handle  
 width 2.2 mm  
 length 5.0 mm  
 thickness 0.2 mm

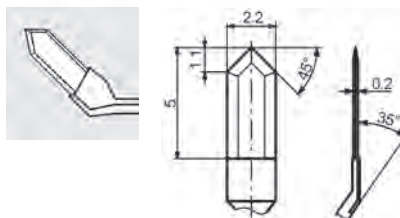



**G-38453**     **DIACLEAN CLEAR-CORNEA-INCISION  
DIAMOND KNIFE, 2.85 MM**  
4 cutting edges, 35° angled  
titanium handle  
width 2.85 mm  
length 5.0 mm  
thickness 0.2 mm

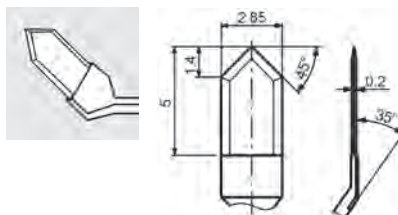

**G-38466**     **DIACLEAN DIAMOND  
CRESCENT KNIFE, 2.0 MM**  
round spatula shape, 40° angled  
titanium handle  
width 2.0 mm  
length 4.0 mm  
thickness 0.2 mm

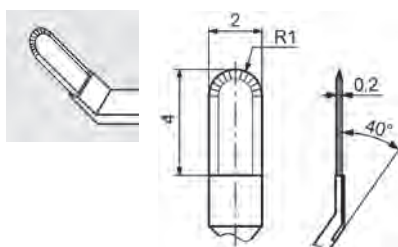

**G-31470**     **TRI-FACET DIAMOND STEP KNIFE**  
single footplate, titanium handle  
stepwise adjustable  
in sterilizing case  
width 1.0 mm  
length 3.0 mm  
thickness 0.2 mm

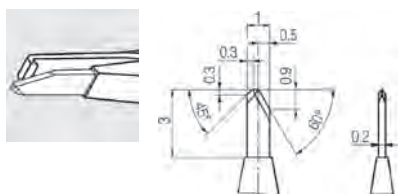

**G-31468**     **LIMBAL RELAXING INCISION  
DIAMOND KNIFE**  
LRI knife with 0.6 mm precalibrated depth  
single footplate, titanium handle  
width 1.0 mm  
length 3.0 mm  
thickness 0.2 mm

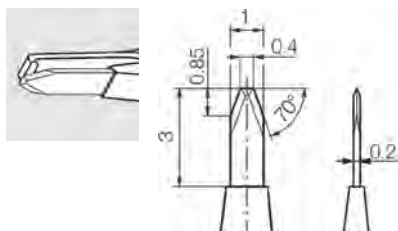

G-31480

**DIAMOND MICROMETER KNIFE**

tri-facet for keratotomy  
vertical and 15° cutting edges with  
0.2 mm flat base cutting edge  
double footplate, titanium handle  
width 0.6 mm  
length 3.0 mm  
thickness 0.1 mm

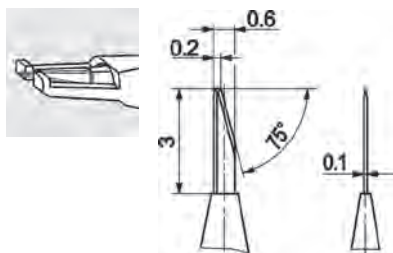

G-19345

**DIAMOND MICROMETER KNIFE**

for keratotomy  
single 45° cutting edge  
double footplate, titanium handle  
width 1.0 mm  
length 3.0 mm  
thickness 0.2 mm

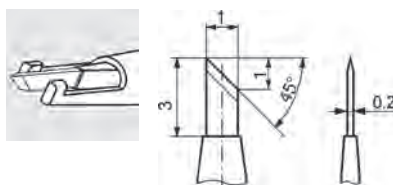

G-31487

**DIAMOND KNIFE**

for viscocanalostomy  
0.5 mm wide, 70° diamond blade  
width 0.5 mm  
length 4.0 mm  
thickness 0.2 mm

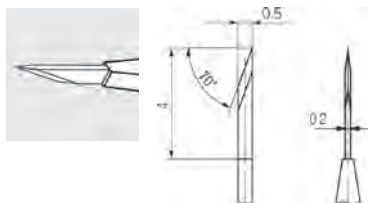

G-31477

**RETINA DIAMOND KNIFE**

45° cutting edge  
20 gauge / 0.9 mm  
titanium handle  
width 0.9 mm  
length 3.0 mm  
thickness 0.2 mm

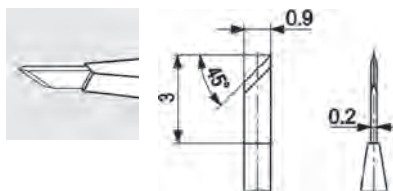



**G-14420** *HAMBURG MODEL*  
**KERATOME**  
angled at 14 mm from tip  
10 mm cutting surface  
1.1 mm wide  
overall length 120 mm



**G-14000** **CHALAZION KNIFE**  
straight, delicate  
10 mm cutting surface  
1.8 mm wide  
overall length 120 mm



**G-14105** **MICRO ROUND KNIFE**  
for viscocanalostomy  
0.8 mm diameter disc-shaped blade  
overall length 112 mm



**G-14180** *BONN MODEL*  
**SCLERAL KNIFE**  
7 mm blade, rounded tip  
overall length 126 mm



**G-14185** *BONN MODEL*  
**SCLERAL KNIFE**  
4 mm blade, rounded tip  
overall length 126 mm



*KUHNT*  
**CORNEAL SCARIFIER**

rounded tip  
overall length 123 mm  
fig. 1, 5.5 mm x 2.5 mm blade  
fig. 2, 4.5 mm x 2.0 mm blade

**G-14010**  
**G-14020**



**G-38621** *SZURMAN*  
**DMEK PREPARATION SCRAPER**

4.0 mm lower blade, blunt  
1.5 mm rounded tip, sharp  
for removal of Descemet's membrane from graft  
overall length 117 mm



**G-14200** *PAUFIQUE*  
**KERATOPLASTY KNIFE**  
2 mm long cutting edge  
1.7 mm wide semi-circular tip  
overall length 105 mm



**G-33670** *LOHMANN*  
**LASEK EPI PEELER**  
"Hockey" knife with  
5 mm bottom blade and 2 mm front blade  
overall length 123 mm



**STILETTO**  
45° lancet  
overall length 53 mm  
for instruments with

**G-33022**  
**G-33025**  
**G-33026**

23 gauge / 0.6 mm  
20 gauge / 0.9 mm  
19 gauge / 1.1 mm





**G-14165**

**SATO KNIFE**

1.5 mm cutting edge  
pointed tip  
overall length 123 mm



**G-16200**

*DARDENNE*  
**SATO KNIFE**

1.2 mm cutting edge  
pointed tip  
overall length 123 mm



**G-37555**

*FOERSTER*  
**SATO KNIFE**

conical shaft  
front: 30 gauge / 0.3 mm  
rear: 20 gauge / 0.9 mm  
overall length 125 mm



**G-14162**

*HANSEN*  
**SATO KNIFE**

double edge,  
for arteriovenous dissection  
20 gauge / 0.9 mm  
overall length 130 mm



**06**

SATO



G-12200

**CRVO KNIFE**

for Radial Opticus Neurotomy (RON)  
with Central Retinal Vein Occlusion (CRVO),  
20 gauge / 0.9 mm  
overall length 120 mm



G-12220

*DITHMAR*

**CRVO KNIFE**

with preset incision depths at 1.5 mm,  
for radial opticus neurotomy (RON)  
with Central Retinal Vein Occlusion (CRVO),  
20 gauge / 0.9 mm  
overall length 129 mm

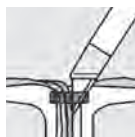

06

CRVO

## TREPHINES





*BEST*  
**TREPHINE**  
overall length 58 mm



<b>G-31815</b>	1.0 mm	<b>G-31835</b>	1.5 mm	<b>G-31855</b>	1.9 mm
<b>G-31820</b>	1.2 mm	<b>G-31840</b>	1.6 mm	<b>G-31860</b>	2.0 mm
<b>G-31825</b>	1.3 mm	<b>G-31845</b>	1.7 mm	<b>G-31865</b>	2.5 mm
<b>G-31830</b>	1.4 mm	<b>G-31850</b>	1.8 mm		

*SCHMIDT-MUMM*  
**DUCT TREPHINE**  
overall length 38 mm



<b>G-20610</b>	1.0 mm	<b>G-20613</b>	1.3 mm	<b>G-20616</b>	1.6 mm
<b>G-20611</b>	1.1 mm	<b>G-20614</b>	1.4 mm	<b>G-20617</b>	1.7 mm
<b>G-20612</b>	1.2 mm	<b>G-20615</b>	1.5 mm	<b>G-20618</b>	1.8 mm

*HAMBURG MODEL*  
**KERATOPLASTY TREPHINE**  
overall length 40 mm



<b>G-20050</b>	5.0 mm	<b>G-20060</b>	6.0 mm	<b>G-20080</b>	8.0 mm
<b>G-20054</b>	5.4 mm	<b>G-20065</b>	6.5 mm	<b>G-20090</b>	9.0 mm
<b>G-20055</b>	5.5 mm	<b>G-20070</b>	7.0 mm	<b>G-20100</b>	10.0 mm

*BEST*  
**KERATOPLASTY TREPHINE**  
overall length 75 mm



<b>G-20450</b>	5.0 mm	<b>G-20470</b>	7.0 mm
<b>G-20455</b>	5.5 mm	<b>G-20480</b>	8.0 mm
<b>G-20460</b>	6.0 mm	<b>G-20490</b>	9.0 mm
<b>G-20465</b>	6.5 mm	<b>G-20500</b>	10.0 mm

*FRANCESCHETTI*  
**KERATOPLASTY TREPHINE**  
overall length 75 mm



<b>G-17250</b>	5.0 mm	<b>G-17270</b>	7.0 mm	<b>G-17290</b>	9.0 mm
<b>G-17251</b>	5.1 mm	<b>G-17271</b>	7.1 mm	<b>G-17291</b>	9.1 mm
<b>G-17260</b>	6.0 mm	<b>G-17280</b>	8.0 mm	<b>G-17300</b>	10.0 mm
<b>G-17261</b>	6.1 mm	<b>G-17281</b>	8.1 mm		

MANY TREPHINES ALSO AVAILABLE IN MINUS, INTERMEDIATE AND PLUS SIZES

**G-31870**

*THOMAS NEUHANN*

**CORNEAL PUNCH**

for keratoplasty trephines with thread from G-33870 to G-33899, with silicone block for donor cornea

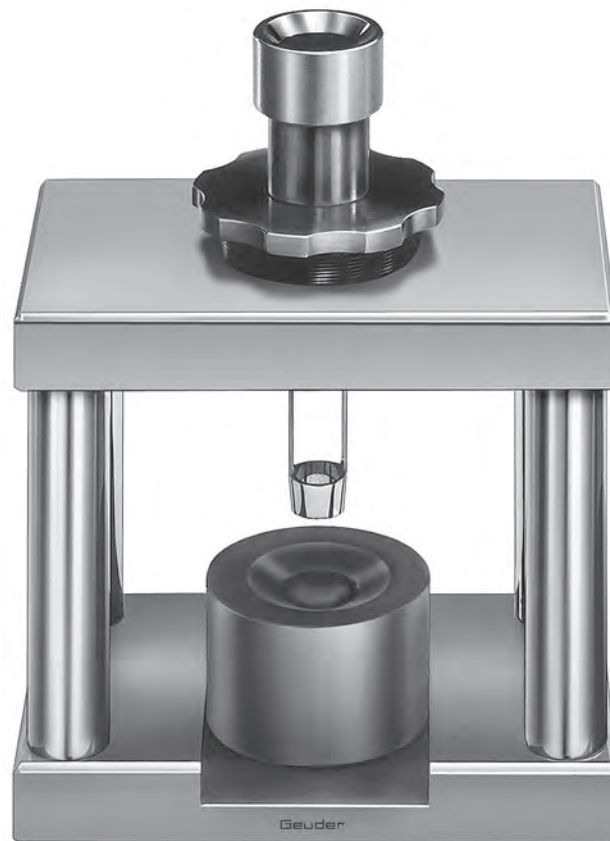

07

TREPHINES · PUNCH

**KERATOPLASTY TREPHINE**

with thread, for *NEUHANN* corneal punch G-31870  
overall length 40 mm



<b>G-33870</b>	7.0 mm	<b>G-33880</b>	8.0 mm	<b>G-33890</b>	9.0 mm
<b>G-33871</b>	7.1 mm	<b>G-33881</b>	8.1 mm	<b>G-33891</b>	9.1 mm
<b>G-33872</b>	7.2 mm	<b>G-33882</b>	8.2 mm	<b>G-33892</b>	9.2 mm
<b>G-33873</b>	7.3 mm	<b>G-33883</b>	8.3 mm	<b>G-33893</b>	9.3 mm
<b>G-33874</b>	7.4 mm	<b>G-33884</b>	8.4 mm	<b>G-33894</b>	9.4 mm
<b>G-33875</b>	7.5 mm	<b>G-33885</b>	8.5 mm	<b>G-33895</b>	9.5 mm
<b>G-33876</b>	7.6 mm	<b>G-33886</b>	8.6 mm	<b>G-33896</b>	9.6 mm
<b>G-33877</b>	7.7 mm	<b>G-33887</b>	8.7 mm	<b>G-33897</b>	9.7 mm
<b>G-33878</b>	7.8 mm	<b>G-33888</b>	8.8 mm	<b>G-33898</b>	9.8 mm
<b>G-33879</b>	7.9 mm	<b>G-33889</b>	8.9 mm	<b>G-33899</b>	9.9 mm

**G-32671**     *ÖRK LINZ MODEL*  
**SILICONE BLOCK FOR DMEK**  
for donor cornea  
white-colored



**G-32672**     **SILICONE BLOCK**  
for donor cornea  
blue-colored



**G-32674**     **SILICONE BLOCK WITH CENTER POINT**  
for donor cornea



**G-38620**     *SZURMAN*  
**DMEK GRAFT RETAINER**  
for preparation of DMEK graft



**07**

SILICONE BLOCKS

**G-21175**     **METAL STAND**  
with removable silicone insert G-21176  
for aspiration of donor cornea



**G-21176**     **SILICONE INSERT**  
for metal stand G-21175



07

SILICONE BLOCKS



## GLAUCOMA PUNCHES RONGEURS





**G-18210**

*CITELLI*

**BONE NIBBLING RONGEUR**

3 mm x 4.5 mm bite  
overall length 150 mm

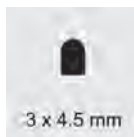

2/5



**G-18220**

*BEYER*

**BONE NIBBLING RONGEUR**

2 mm x 3 mm bite  
overall length 140 mm

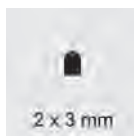

2/5



**G-18225**

*KERRISON*

**BONE NIBBLING RONGEUR**

5 mm x 3.5 mm bite  
overall length 160 mm

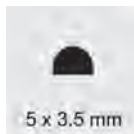

2/5



**08**

RONGEURS

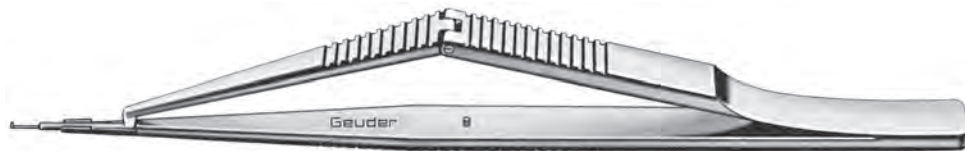

**G-18238** *KELLY*  
**DESCEMET'S MEMBRANE PUNCH**  
 for Glaucoma  
 19 gauge / 1.0 mm  
 0.9 mm x 0.45 mm bite  
 overall length 122 mm

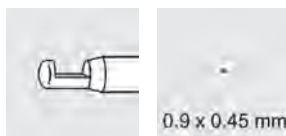

08

GLAUCOMA PUNCHES



**G-18239** *LUNTZ-DODICK*  
**TRABECULECTOMY PUNCH**  
 for Glaucoma  
 with 360° rotatable cutting head  
 1 mm x 0.5 mm bite  
 overall length 115 mm



**G-18235** *GREHN*  
**MICRO TRABECULECTOMY PUNCH**  
 for Glaucoma  
 20 gauge / 0.9 mm  
 0.7 mm x 0.3 mm bite  
 overall length 90 mm





**G-18237** *GASS*  
**CORNEOSCLERAL PUNCH**  
for Glaucoma  
with 360° rotatable cutting head  
1.5 mm x 0.6 mm bite  
overall length 85 mm



**G-18232** *MOHR*  
**GLAUCOMA PUNCH**  
1 mm circular bite  
overall length 78 mm

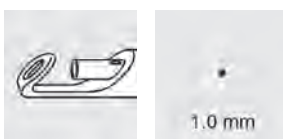





CORNEAL .....	81
STITCH .....	82
CAPSULE .....	84
IRIS .....	86
IOL .....	87
TENOTOMY .....	89
STRABISMUS .....	90
MISCELLANEOUS · RING HANDLE .....	91
ENUCLEATION .....	94
VITREORETINAL .....	95





*TROUTMAN*

**CORNEAL SCISSORS**

7 mm blades  
9.5 mm from tip to pivot  
overall length 100 mm  
right, curved blades, blunt tips  
left, curved blades, blunt tips

**G-19710**  
**G-19715**



*CASTROVIEJO*

**CORNEAL SCISSORS**

lower blade 9.5 mm  
upper blade 9.0 mm  
overall length 105 mm  
right, curved blades, blunt tips  
left, curved blades, blunt tips

**G-19690**  
**G-19695**



*KATZIN*

**KERATOPLASTY SCISSORS**

6 mm blades  
8 mm from tip to pivot  
overall length 100 mm  
right, curved blades, blunt tips  
left, curved blades, blunt tips

**G-19720**  
**G-19725**



**G-19718**

*SAUTTER*

**CORNEAL SCISSORS**

light curve, fine blunt tips  
10 mm blades  
14 mm from tip to pivot  
overall length 100 mm



**G-19780**

*CASTROVIEJO*

**CORNEAL SCISSORS**

strong curve, blunt tips  
12 mm blades  
15 mm from tip to pivot  
overall length 103 mm



**G-19790**

*CASTROVIEJO*

**CORNEAL SCISSORS**

angled to side, blunt tips  
12 mm blades  
overall length 110 mm



**CORNEAL SCISSORS**

light curve  
8 mm blades  
overall length 105 mm  
sharp tips  
blunt tips

**G-19600**  
**G-19605**



**CORNEAL SCISSORS**

strong curve, blunt tips  
6 mm blades, overall length 105 mm  
11 mm blades, overall length 110 mm

**G-19607**  
**G-19615**



**G-19727**

*MACKENSEN*  
**KERATOPLASTY SCISSORS**  
strong curve, blunt tips  
overall length 85 mm



**G-19585**

**CORNEAL SECTION SCISSORS**  
angled up, 8 mm blades  
blunt tips  
overall length 100 mm



**G-19570**

**MICRO STITCH SCISSORS**  
straight, 8 mm blades  
sharp tips  
overall length 105 mm



**G-19580**

*FINE*  
**STITCH SCISSORS**  
straight, 14 mm blades  
sharp tips  
overall length 110 mm



**G-19590** *CASTROVIEJO*  
**ANTERIOR SYNECHIA SCISSORS**  
angled up  
9 mm vaulted blades, blunt tips  
overall length 105 mm



**G-19740** *CASTROVIEJO*  
**ANTERIOR SYNECHIA SCISSORS**  
angled up  
15 mm vaulted blades, blunt tips  
overall length 115 mm



**TRABECULUM SCISSORS**  
sharp tips  
8.5 mm blades  
1.5 mm pivot width  
overall length 80 mm  
**G-19745** straight  
**G-19747** curved



**CAPSULOTOMY SCISSORS**  
angled up, sharp tips  
2 mm pivot width  
overall length 80 mm  
**G-19776** 9 mm blades  
**G-19777** 11 mm blades



**G-32100** **CAPSULOTOMY SCISSORS**  
angled, lightly curved tips  
13 mm blades  
2 mm pivot width  
overall length 80 mm



**G-32101** **CAPSULOTOMY SCISSORS**  
angled, strongly curved tips  
13 mm blades  
2 mm pivot width  
overall length 80 mm



**G-32105** **CAPSULOTOMY SCISSORS**  
lightly curved, sharp tips  
11 mm blades  
1.8 mm pivot width  
overall length 88 mm



**G-32023 CAPSULOTOMY SCISSORS**

curved, sharp tips  
7 mm blades  
1.8 mm pivot width  
overall length 80 mm



**G-19620 TUEBINGEN MODEL CAPSULOTOMY SCISSORS**

straight, sharp tips  
9 mm blades  
1.8 mm pivot width  
overall length 88 mm



**G-19630 TUEBINGEN MODEL CAPSULOTOMY SCISSORS**

curved, sharp tips  
9 mm blades  
1.8 mm pivot width  
overall length 88 mm



**G-19760 VANNAS CAPSULOTOMY SCISSORS**

extra delicate, straight  
6 mm blades, sharp tips  
1.7 mm pivot width  
overall length 80 mm



**G-19765 VANNAS CAPSULOTOMY SCISSORS**

extra delicate, curved  
6 mm blades, sharp tips  
1.7 mm pivot width  
overall length 80 mm



**G-19770 VANNAS CAPSULOTOMY SCISSORS**

extra delicate, angled to side  
7 mm blades, sharp tips  
overall length 80 mm



09

CAPSULOTOMY · CAPSULE

**G-19775** *VANNAS*  
**CAPSULOTOMY SCISSORS**  
extra delicate, angled up  
7 mm blades, sharp tips  
overall length 80 mm



**G-32940** *H.-R. KOCH*  
**CAPSULE SCISSORS**  
horizontal, 45° angled  
2.5 mm blades, 360° rotatable head  
22 gauge / 0.7 mm straight shaft  
overall length 107 mm



**G-32942** *BRAUWEILER*  
**CAPSULE SCISSORS**  
vertical, 1.25 mm blades  
22 gauge / 0.7 mm curved shaft  
overall length 100 mm



**G-38246** *YAE*  
**CAPSULE SCISSORS**  
interchangeable, titanium, gold-colored  
3 mm straight micro blades  
23 gauge / 0.6 mm curved shaft  
for cutting synechia, iridotomies,  
and to rescue the rhexis during MICS  
overall length 42 mm  
for use with handle G-38240



**G-38240** *JAPAN MODEL*  
**HANDLE**  
for capsule scissors and forceps  
6 mm, titanium  
overall length 90 mm



09

CAPSULOTOMY · ROTATABLE · INTERCHANGEABLE



*OSHER*  
**CAPSULE SCISSORS**  
 360° rotatable and interchangeable tips  
 22 gauge / 0.7 mm  
 overall length 45 mm  
 to use with handpiece  
 G-38215



*OSHER*  
**CAPSULE SCISSORS**  
 45° angled  
 G-38232



*OSHER*  
**CAPSULE SCISSORS**  
 horizontal, 45° angled  
 G-38236



*OSHER*  
**CAPSULE SCISSORS**  
 horizontal, 90° angled  
 G-38238

*OSHER*  
**HANDPIECE FOR CAPSULE SCISSORS**  
 8 mm titanium handpiece, gold-colored  
 G-38215



09

CAPSULE (INTERCHANGEABLE AND ROTATABLE) · IRIS

G-32948

*HATTENBACH*  
**HYBRID SCISSORS**  
 to cut sutures during iris and dislocated IOL fixation  
 1.25 mm blades  
 25 gauge / 0.5 mm angled shaft



G-19540  
 G-19545  
 G-19550

*NOYES*  
**IRIS SCISSORS**  
 straight  
 18 mm blades  
 overall length 120 mm  
 sharp tips  
 sharp-blunt  
 blunt tips



G-19640  
 G-19655

*WECKER*  
**IRIS SCISSORS**  
 11 mm blades  
 overall length 110 mm  
 sharp tips  
 blunt tips



*WECKER*  
**IRIS SCISSORS**  
7 mm blades  
overall length 110 mm  
sharp tips  
blunt tips

**G-19660**  
**G-19675**



**G-19680** *BARRAQUER*  
**IRIS SCISSORS**  
7 mm blades  
blunt tips  
overall length 56 mm



**G-32945** *STEINMETZ*  
**IOL SCISSORS**  
6.5 mm upper blade  
serrated lower tip with groove  
overall length 92 mm  
For cutting acrylic and silicone foldable IOLs



**G-32946** *STEINMETZ*  
**IOL SCISSORS**  
for small incision technique  
6.5 mm upper blade  
serrated lower tip with groove  
overall length 92 mm  
For cutting acrylic and silicone foldable IOLs





*SNYDER-OSHER*

**IOL SCISSORS**

For cutting acrylic and silicone foldable IOLs  
 lower notched blade to create IOL traction  
 18 gauge / 1.2 mm shaft  
 overall length 150 mm



- G-32998 short model, 3.5 mm blades
- G-32996 long model, 4.5 mm blades



G-32800

*H.-R. KOCH*

**SILICONE LENS BI-SECTOR**

for dividing implanted silicone lenses  
 overall length without wire loop 130 mm  
 5 wire loops included (G-32811)

**WIRE LOOP**

for *H.-R. KOCH* silicone lens bi-sector  
 (G-32800)  
 overall length 65 mm (loop 12 mm)



- G-32810 1 piece
- G-32811 5 pieces



**COMBINED  
 NEEDLE HOLDER / SCISSORS**

curved 12 mm blades with  
 3 mm needle holder and tying platform  
 used to hold, place, and cut fine suture material  
 overall length 125 mm



- G-17440 without lock
- G-17441 with lock



**G-19750** *WESTCOTT*  
**SCISSORS**  
blunt tips  
curved, standard blades  
overall length 120 mm



**G-19751** *WESTCOTT*  
**SCISSORS**  
pointed tips  
curved, standard blades  
overall length 120 mm



**G-32250** *WESTCOTT*  
**SCISSORS**  
blunt tips  
curved, delicate blades  
overall length 100 mm



*STEVENS*  
**TENOTOMY SCISSORS**  
short blades, blunt tips  
22 mm from tip to pivot  
overall length 105 mm  
**G-19470** straight  
**G-19475** curved



*STEVENS*  
**TENOTOMY SCISSORS**  
long blades, blunt tips  
28 mm from tip to pivot  
overall length 110 mm  
**G-19480** straight  
**G-19485** curved



G-32614

*BONN MODEL*

**TENOTOMY SCISSORS**

curved blades, blunt tips  
24 mm from tip to pivot  
overall length 90 mm



G-19430

*BONN MODEL*

**STRABISMUS SCISSORS**

blunt tips  
24 mm from tip to pivot  
overall length 90 mm

G-19435

straight

curved



G-19420

**STRABISMUS SCISSORS**

long blade  
28 mm from tip to pivot  
overall length 105 mm

G-19425

straight

curved



09

TENOTOMY · STRABISMUS · RING HANDLE

**STRABISMUS SCISSORS**

short blade  
28 mm from tip to pivot  
overall length 110 mm

**G-19460**

straight

**G-19465**

curved



**EYE SCISSORS**

straight, sharp tips  
overall length: tip to pivot:

**G-19350**

90 mm

27 mm

**G-19355**

100 mm

29 mm

**G-19360**

110 mm

30 mm

**G-19365**

120 mm

36 mm



**EYE SCISSORS**

curved, sharp tips  
overall length: tip to pivot:

**G-19370**

90 mm

25 mm

**G-19375**

100 mm

28 mm

**G-19380**

110 mm

29 mm

**G-19385**

120 mm

34 mm



**EYE SCISSORS**

delicate, sharp tips  
31 mm from tip to pivot  
overall length 105 mm

**G-19390**

straight

**G-19395**

curved



*BONN MODEL*  
**EYE SCISSORS**

extra delicate  
sharp tips  
19 mm from tip to pivot  
overall length 90 mm

**G-19400**

curved

**G-19405**

straight



**G-19410**

*SPENCER*  
**STITCH SCISSORS**

20 mm straight blades  
with hook to lift and  
secure sutures before cutting  
overall length 90 mm



09

UTILITY · STITCH · RING HANDLE

**G-19450**     *GRAEFE*  
**EYE SCISSORS**  
angled up  
blunt tips  
overall length 90 mm



**G-19505**     **EYE SCISSORS**  
angled to side, probe tip  
sharp-blunt  
overall length 115 mm



**G-19510**     **EYE SCISSORS**  
angled to side, probe tips  
blunt tips  
overall length 115 mm



**G-31315**

**OPERATING SCISSORS**

straight blades  
sharp-blunt  
overall length 145 mm



**ENUCLEATION SCISSORS**

curved blades, blunt  
40 mm from tip to pivot  
overall length 135 mm

**G-19520**

**G-19525**

**G-19530**

strong curve  
medium curve  
light curve



09

UTILITY · ENUCLEATION · RING HANDLE

**20 GAUGE**

**VITREORETINAL SCISSORS**

20 gauge / 0.9 mm  
titanium handle  
gold-colored  
overall length 155 mm



45° angle  
horizontal  
**G-36502** 6 mm handle  
**G-36504** 8 mm handle



curved  
with membrane peeler  
**G-36506** 6 mm handle  
**G-36508** 8 mm handle



curved  
**G-36512** 6 mm handle  
**G-36514** 8 mm handle



*KROLL*  
angled, with membrane peeler  
**G-36516** 6 mm handle  
**G-36518** 8 mm handle



angled, blunt tips  
for MIS  
**G-36522** 6 mm handle  
**G-36524** 8 mm handle



*HEIMANN*  
angled  
**G-36526** 6 mm handle  
**G-36528** 8 mm handle

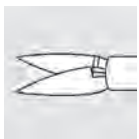

*HEIMANN*  
straight  
**G-36532** 6 mm handle  
**G-36534** 8 mm handle

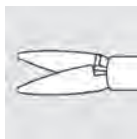

*HEIMANN*  
straight, blunt tips  
**G-36536** 6 mm handle  
**G-36538** 8 mm handle



60° angled  
**G-36546** 6 mm handle  
**G-36548** 8 mm handle



curved  
horizontal  
**G-36552** 6 mm handle  
**G-36554** 8 mm handle



*NAITO*  
long blade 3.5 mm  
curved, tapered tip  
**G-36556** 6 mm handle  
**G-36558** 8 mm handle



*ROIDER*  
for RPE transplantation, vitrectomies  
and retinectomies  
**G-36572** 6 mm handle  
**G-36574** 8 mm handle

23 GAUGE

VITREORETINAL SCISSORS

23 gauge / 0.6 mm  
titanium handle  
gold-colored  
overall length 155 mm



curved

**G-36566** 6 mm handle  
**G-36568** 8 mm handle

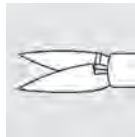

HEIMANN  
straight

**G-36576** 6 mm handle  
**G-36578** 8 mm handle



HEIMANN  
for use with 23 gauge trocar system  
angled, sharp tips

**G-36540** 6 mm handle  
**G-36541** 8 mm handle

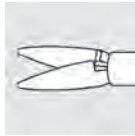

HEIMANN  
straight, blunt tips

**G-36582** 6 mm handle  
**G-36584** 8 mm handle

25 GAUGE

VITREORETINAL SCISSORS

25 gauge / 0.5 mm  
titanium handle  
gold-colored



curved

**G-36562** 6 mm handle  
**G-36564** 8 mm handle

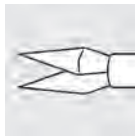

HEIMANN  
straight

**G-36586** 6 mm handle  
**G-36588** 8 mm handle



**ERGOLINE**

**ERGOLINE SCISSORS**

360° rotatable and interchangeable tips  
for Ergoline handles 6 and 8 mm diameter  
overall length 55 mm

**ERGOLINE HANDPIECE**

for Ergoline scissors  
gold-colored  
overall length 105 mm

**G-36900** 6 mm titanium handpiece

**G-36901** 8 mm titanium handpiece



**ERGOLINE SCISSORS**

45° angled  
horizontal  
20 gauge / 0.9 mm

**G-36902**



*KROLL*

**ERGOLINE SCISSORS**

angled, with membrane peeler  
20 gauge / 0.9 mm

**G-36915**



*HEIMANN*

**ERGOLINE SCISSORS**

angled  
20 gauge / 0.9 mm

**G-36925**

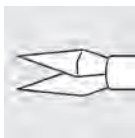

*HEIMANN*

**ERGOLINE SCISSORS**

straight  
**G-36930** 20 gauge / 0.9 mm  
**G-36975** 23 gauge / 0.6 mm  
**G-36985** 25 gauge / 0.5 mm



*NAITO*

**ERGOLINE SCISSORS**

long blade 3.5 mm, curved  
tip tapered to 0.75 mm  
20 gauge / 0.9 mm  
**G-36955** 20 gauge / 0.9 mm



**CLEANING ADAPTER**

for rotatable and  
interchangeable tips

**G-36604**

SINGLE-USE  
INTERCHANGEABLE SCISSORS  
AVAILABLE ON P. 218







CILIA.....	101
CONJUNCTIVA.....	102
SUTURING.....	103
CORNEAL.....	104
TYING.....	105
FIXATION.....	109
IRIS.....	110
CAPSULORHEXIS.....	113
IOL.....	121
MUSCLE.....	126
VITREORETINAL.....	129
CHALAZION.....	134
MOSQUITO.....	135
SERREFINES · TOWEL CLAMPS.....	136



**G-18720**     *HENRY*  
**CILIA FORCEPS**  
straight jaws  
smooth, blunt, squared tips  
overall length 100 mm



**G-18730**     *GRADLE*  
**CILIA FORCEPS**  
curved jaws  
smooth, blunt, squared tips  
overall length 98 mm



**G-18750**     *BARRAQUER*  
**CILIA FORCEPS**  
lightly angled  
6.5 mm platform  
overall length 109 mm



**G-18740**     *BEER*  
**CILIA FORCEPS**  
3 mm platform  
rounded tips 4.5 mm wide  
overall length 78 mm



**G-18850**     *SHAAF*  
**CILIA AND FOREIGN BODY FORCEPS**  
grooved tips  
curved and pointed  
finger grip handle  
overall length 96 mm



**G-31620**     *BARRAQUER*  
**CILIA AND SUTURE FORCEPS**  
grooved tips, 7.0 mm platform  
curved and pointed  
finger grip handle  
overall length 112 mm



**G-32740**     *HAMBURG MODEL*  
**CILIA AND FOREIGN BODY FORCEPS**  
tapered fine tips  
overall length 90 mm



**G-31230** *KREFELD MODEL*  
**CONJUNCTIVA FORCEPS**  
 standard  
 1 x 2 teeth  
 overall length 100 mm

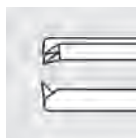

**G-31235** *FREIBURG MODEL*  
**CONJUNCTIVA FORCEPS**  
 delicate  
 1 x 2 teeth  
 overall length 90 mm

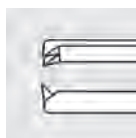

**G-18847** *KAUFMANN*  
**CONJUNCTIVA FORCEPS**  
 standard  
 1 x 2 teeth  
 5 mm tying platform  
 overall length 75mm

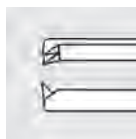

**G-18810** *DRAEGER*  
**CONJUNCTIVA FORCEPS**  
 1.2 mm wide  
 2 atraumatic fixation knobs  
 overall length 97 mm



**G-18848** *FOERSTER*  
**CONJUNCTIVA FORCEPS**  
 delicate  
 1 x 2 teeth  
 finger grip handle  
 overall length 95 mm

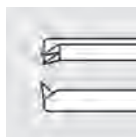



*CASTROVIEJO*  
**SUTURING FORCEPS**  
1 x 2 teeth  
6 mm tying platform  
overall length 100 mm



- G-19001** 0.28 mm, teeth 0.12 mm
- G-19005** 0.3 mm
- G-19010** 0.6 mm
- G-19015** 0.9 mm
- G-19020** 1.2 mm



*CASTROVIEJO*  
**SUTURING FORCEPS**  
new model  
1 x 2 teeth  
6 mm tying platform  
overall length 109 mm



- G-19022** 0.25 mm, teeth 0.12 mm
- G-19023** 0.3 mm
- G-19024** 0.6 mm
- G-19025** 0.9 mm
- G-19026** 1.2 mm



**G-19008** *MUNICH MODEL*  
**SUTURING FORCEPS**  
1 x 2 teeth, 0.35 mm  
5.5 mm tapered tying platform  
overall length 100 mm

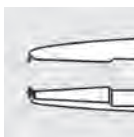

*ZUERICH MODEL*  
**SUTURING FORCEPS**  
delicate

1 x 2 teeth, 0.12 mm  
5 mm tying platform  
overall length 75 mm

**G-18965**

**G-18966**

straight

angled



**G-18950**

**COLIBRI FORCEPS**

1 x 2 teeth, 0.12 mm  
5 mm tying platform  
overall length 75 mm



**G-18960**

**MICRO COLIBRI FORCEPS**

delicate  
1 x 2 teeth, 0.12 mm  
5 mm tying platform  
overall length 77 mm



**G-15134**

**MICRO COLIBRI FORCEPS**

extra delicate  
1 x 2 teeth, 0.12 mm  
4 mm tying platform  
overall length 76 mm



**G-18975**

*BARRAQUER*  
**SUTURE REMOVING FORCEPS**

very fine pointed tips  
4 mm tying platform  
overall length 77 mm



**G-18972**

*THOMAS NEUHANN*  
**KERATOPLASTY FORCEPS**

for corneal suturing and fixation  
two prongs with 1 x 2 teeth  
0.8 mm prong spread  
overall length 80mm





**G-18970**

*REMKY*

**KERATOPLASTY FORCEPS**

two prongs with 1 x 1 teeth, angled  
1.7 mm prong spread  
for corneal suturing and fixation  
overall length 80 mm



**G-38623**

*REMKY*

**DMEK KERATOPLASTY FORCEPS**

modified by *SZURMAN*  
two prongs with 1 x 1 teeth, straight  
1.7 mm prong spread  
33 mm shafts  
to hold graft during preparation  
overall length 89 mm

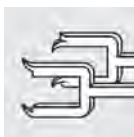

**G-18940**

*PAUFIQUE*

**UNIVERSAL SUTURING FORCEPS**

1 x 2 teeth  
6 mm tying platform  
overall length 88 mm

standard

**G-18945**

delicate

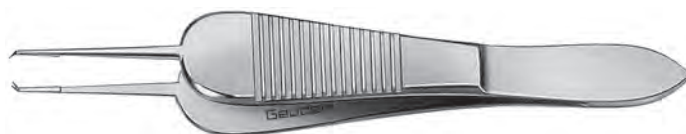
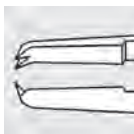

**G-19045**

*PAUFIQUE*

**TYING FORCEPS**

with platform  
overall length 88 mm

standard, 6 mm platform

**G-19046**

delicate, 5 mm platform

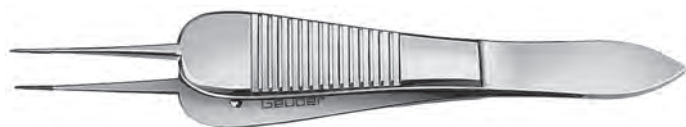
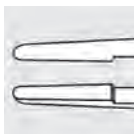

G-19030

TUEBINGEN MODEL

**TYING FORCEPS**

straight, smooth jaws

6 mm tying platform

overall length 101 mm

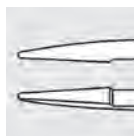

G-19040

TUEBINGEN MODEL

**TYING FORCEPS**

curved, smooth jaws

6 mm tying platform

overall length 99 mm



G-19035

TUEBINGEN MODEL

**TYING FORCEPS**

delicate, smooth jaws

4 mm tying platform

overall length 84mm

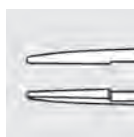

G-19034

BONN MODEL

**TYING FORCEPS**

extra delicate, smooth jaws

3 mm tying platform

overall length 73 mm

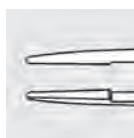

10

TYING

**G-19032** **TYING FORCEPS**  
angled, 7.5 mm  
6 mm tying platform  
overall length 99 mm



**G-31625** *DARDENNE*  
**TYING FORCEPS**  
angled, 6.5 mm  
6 mm tying platform  
round handle with guide pin  
overall length 102 mm



**G-19038** *BANGERTER*  
**TYING FORCEPS**  
9.5 mm platform  
longitudinal v-shape groove  
overall length 100 mm



**G-19048** **TYING FORCEPS**  
utility serrated jaws  
1 mm wide  
overall length 106 mm



**G-32947**

*HATTENBACH*  
**HYBRID TYING FORCEPS**  
 angled, for the anterior chamber  
 intraocular 1.5 mm micro tying tips  
 25 gauge / 0.5 mm  
 overall length 98 mm

for use in combination with  
 hybrid needle holder G-32949



**G-31623**

*KELMAN-MCPHERSON*  
**FRAGMENT FORCEPS**  
 angled, smooth jaws  
 7.5 mm platform  
 overall length 100 mm

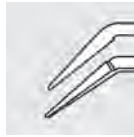

**G-33941**

*KELMAN-MCPHERSON*  
**FRAGMENT FORCEPS**  
 angled, fine grooved jaws,  
 for femto-LASIK to retrieve lenticule  
 during SMILE procedures  
 7.5 mm platform  
 overall length 100 mm



**G-31622**

*GASKIN*  
**FRAGMENT FORCEPS**  
 angled  
 with tying platform  
 9 mm platform, overall length 107 mm

**G-31624**

11 mm platform, overall length 100 mm



10

TYING · IRIS SUTURE · FRAGMENT

**G-37700**      **JEWELERS TYPE FORCEPS**  
standard, straight  
overall length 120 mm



**G-37705**      **JEWELERS TYPE FORCEPS**  
delicate, straight  
overall length 115 mm



**G-37710**      **JEWELERS TYPE FORCEPS**  
extra delicate, straight  
overall length 115 mm



**G-19080**      *BARRAQUER*  
**FIXATION FORCEPS**  
3 sets of 1 x 2 teeth  
11 mm fixation platform  
overall length 100 mm



*GRAEFE*  
**FIXATION FORCEPS**  
4.5 mm wide  
8 interlocking teeth  
overall length 110 mm  
**G-19050**      without lock  
**G-19055**      with lock



**G-19060**      *HEIDELBERG MODEL*  
**FIXATION FORCEPS**  
3.5 mm wide  
6 interlocking teeth  
overall length 110 mm



**DRESSING FORCEPS**

serrated jaws  
overall length 100 mm

- G-18780 0.5 mm
- G-18781 0.7 mm
- G-18782 1.0 mm
- G-18783 1.2 mm
- G-18784 1.4 mm

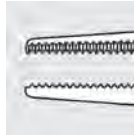

**TISSUE FORCEPS**

1 x 2 teeth  
overall length 100 mm

- G-18790 0.5 mm
- G-18791 0.7 mm
- G-18792 1.0 mm
- G-18793 1.2 mm
- G-18794 1.4 mm

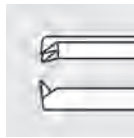

**IRIS FORCEPS**

serrated, delicate  
overall length 73 mm  
straight  
curved

- G-18855
- G-18856



*BONN MODEL*  
**IRIS FORCEPS**

serrated, extra delicate  
overall length 73 mm  
straight  
angled at 6 mm  
angled at 8 mm

- G-18908
- G-18906
- G-18911

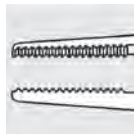

*BONN MODEL*  
**IRIS FORCEPS**

1 x 2 teeth, 0.12 mm  
extra delicate  
overall length 73mm  
straight  
angled at 6 mm  
angled at 8 mm

- G-18900
- G-18905
- G-18910



*BONN MODEL*

**IRIS FORCEPS**

long, straight  
1 x 2 teeth, 0.12 mm  
overall length 102 mm

**G-18845**

**G-18890**

extra delicate  
delicate, with 4.5 mm tying platform

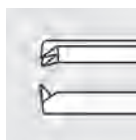

**G-18840**

*SWISS MODEL*

**IRIS FORCEPS**

curved, 1 x 2 teeth  
overall length 100 mm



**G-18860**

*HEIDELBERG MODEL*

**IRIS FORCEPS**

light curve, 1 x 2 teeth  
overall length 72 mm



**G-18870**

*HEIDELBERG MODEL*

**IRIS FORCEPS**

strong curve, 1 x 2 teeth  
overall length 70 mm



**G-18857**

**IRIS FORCEPS**

straight, delicate  
1 x 2 teeth  
overall length 72 mm

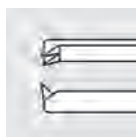

**G-31953**

**IRIS FORCEPS**

straight, strong  
1 x 2 teeth  
overall length 72 mm

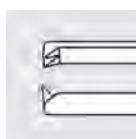

G-18846

*HAMBURG MODEL*

**IRIS FORCEPS**

straight, delicate

1 x 2 teeth

overall length 103 mm

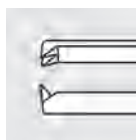

G-32240

*SWISS MODEL*

**IRIS FORCEPS**

straight, extra delicate

1 x 2 teeth

overall length 70 mm

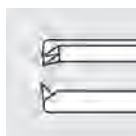

G-18880

*HESS-ENGELKING*

**IRIS FORCEPS**

1 x 2 teeth

overall length 72 mm

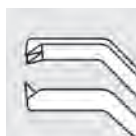

10

IRIS FIXATION

G-18897

*ELZE*

**IRIS FORCEPS**

extra delicate

1 x 2 teeth

overall length 78 mm



G-18913

*THOMAS NEUHANN*

**IRIS FORCEPS**

curved shaft

1 x 2 teeth

23 gauge / 0.6 mm

overall length 95 mm





**G-31307**

**CAPSULORHEXIS FORCEPS**

strong, with heel stop to protect the iris  
interlocking micro serrated tips  
12 mm straight shafts  
overall length 103 mm



**G-31308**

**CAPSULORHEXIS FORCEPS**

round handle with guide pin  
extra delicate with  
interlocking micro serrated tips  
13 mm curved shafts  
overall length 105 mm



**G-31300**

*MASKET*

**CAPSULORHEXIS FORCEPS**

delicate, with heel stop to protect the iris  
interlocking micro serrated tips  
12 mm curved shafts  
overall length 103 mm



**G-31304**

**CAPSULORHEXIS FORCEPS**

new model, with guide pin  
extra delicate with  
interlocking micro serrated tips  
13 mm curved shafts  
overall length 103 mm



G-31301

**CAPSULORHEXIS FORCEPS**

extra delicate  
with smooth triangular grasping tips  
13 mm curved shafts  
overall length 98 mm



G-31305

**CAPSULORHEXIS FORCEPS**

extra delicate with  
interlocking micro serrated tips  
13 mm curved shafts  
overall length 98 mm



10

CAPSULORHEXIS

G-31303

*H.-R. KOCH*  
**CAPSULORHEXIS FORCEPS**

extra delicate with  
interlocking micro serrated tips  
13 mm curved shafts  
1 mm marks from tip to bent  
overall length 98 mm



G-31299

**CAPSULORHEXIS FORCEPS**

short handle, extra delicate  
cross serrated grasping tips  
12 mm straight shafts  
overall length 83 mm

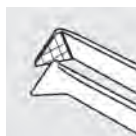

**G-32926**

*AUFFARTH*

**MICS DOUBLE CROSS ACTION CAPSULORHEXIS FORCEPS**

interlocking micro serrated tips  
12 mm curved shafts, angled 130°  
with overlap system  
prevents inadvertent iris capture  
for 1.6 mm incisions  
overall length 100 mm



**G-32928**

*INAMURA*

**MICS CAPSULORHEXIS FORCEPS**

cross action  
interlocking micro serrated tips  
10.5 mm curved shafts tip to pivot  
angled 130°  
overall length 103 mm



**G-31306**

*KAMPIK*

**MICS CAPSULORHEXIS FORCEPS**

22 gauge / 0.7 mm curved shaft  
90° cystotome tips, reverse action  
overall length 93 mm



**G-32935**

*H.-R. KOCH*

**MICS CAPSULE FORCEPS**

short handle  
22 gauge / 0.7 mm curved shaft with  
micro grasping tips  
overall length 98 mm





**G-32938** *H.-R. KOCH*  
**MICS CAPSULE FORCEPS**  
 22 gauge / 0.7 mm curved shaft with  
 micro grasping tips  
 6 mm titanium handle, blue-colored  
 overall length 144 mm



**G-32936** *TOBIAS NEUHANN*  
**MICRO FORCEPS**  
 multifunction asymmetrical tips with  
 grasping platform  
 23 gauge / 0.6 mm straight shaft  
 6 mm titanium handle, blue-colored  
 overall length 155 mm



**G-32937** *IKEDA*  
**MICS CAPSULORHEXIS FORCEPS**  
 23 gauge / 0.6 mm curved shaft with  
 micro grasping tips  
 6 mm titanium handle, blue-colored  
 overall length 144 mm



*IKEDA*  
**CAPSULORHEXIS FORCEPS**  
 interchangeable tips  
 23 gauge / 0.6 mm curved shaft  
 overall length 40 mm

**G-38244** textured, micrograsping tips "BEAK"  
**G-38242** textured, micrograsping tips



G-38244  
 "beak"



G-38242



for use with handle G-38240

**G-38240** *JAPAN MODEL*  
**HANDLE**  
 for capsule scissors and forceps  
 interchangeable tips  
 6 mm, titanium  
 overall length 90 mm



**G-32944**

*HATTENBACH*

**CAPSULORHEXIS FORCEPS**

25 gauge / 0.5 mm angled shaft with  
micro grasping tips  
overall length 88 mm



**G-18805**

*TOBIAS NEUHANN*

**DESCEMET MEMBRANE FORCEPS**

delicate blunt grasping tips  
with platform  
overall length 75 mm



**G-38624**

*SZURMAN*

**DMEK PREPARATION FORCEPS**

for removal of Descemet layer  
with smooth round tips to prevent tearing  
the donor endothelium  
overall length 75 mm



**G-38628**

*YÖRÜK*

**DMEK TRANSPLANT FORCEPS**

atraumatic grasping and removal of  
Descemet's membrane  
grasping area 6 mm  
overall length 77 mm



**G-38634**

*GERTEN*

**DSAEK/DMEK RHEXIS FORCEPS**

for Descemetorhexis  
reversed triangular tips to  
score and remove the DM from the host cornea  
23 gauge / 0.6 mm curved shaft  
overall length 142 mm





**G-38603** **DSAEK IMPLANTATION FORCEPS**  
 13 mm curved shafts with limited closing  
 to avoid injury of endothelial transplant  
 1.5 mm serrated platform  
 overall length 107 mm



**G-38606** *THOMAS NEUHANN*  
**DSAEK FORCEPS**  
 1 x 2 teeth, 0.12 mm  
 21 gauge / 0.8 mm curved shaft  
 for endothelial transplant procedures  
 overall length 97 mm



**G-33428** *PFAEFFL*  
**FLAPORHEXIS FORCEPS**  
 2.5 mm x 1.5 mm cross serrated tips, oval  
 to lift femto-LASIK flaps  
 overall length 103 mm



**G-33429** *KNORZ*  
**FEMTO-LASIK FLAP FORCEPS**  
 curved 3.25 mm T-bar  
 textured  
 to grasp and lift LASIK flaps  
 overall length 102 mm





**G-31899** **LASIK CORNEAL FLAP FORCEPS**  
angled shafts, 9 mm  
highly polished round and smooth shafts  
overall length 108 mm



**G-18914** *BURATTO*  
**LASIK CORNEAL FLAP FORCEPS**  
curved shafts  
cross serrated tips, 0.8 mm diameter  
overall length 100 mm



**G-33960** *RUPAL SHAH*  
**LENTICULE FORCEPS**  
3.5 mm serrated tips  
20 gauge / 0.9 mm curved shaft  
to retrieve lenticule during SMILE procedures  
6 mm titanium handle, blue-colored  
overall length 144 mm



**G-33961** **LENTICULE FORCEPS**  
7.5 mm shafts  
with fine grooves  
angled to side  
to retrieve lenticule during SMILE procedures  
overall length 99 mm





**G-31518** **NUCLEUS SPREADING FORCEPS**  
 cross-action  
 3.0 mm textured paddle tips  
 for cracking the nucleus  
 overall length 112 mm

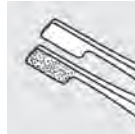

**G-31519** *AKAHOSHI*  
**NUCLEUS SPREADING FORCEPS**  
 phaco prechopper  
 4.5 mm delicate sharp tips, 1 mm profile  
 2.0 mm cross-action  
 for cracking, dividing, and rotating the nucleus  
 overall length 105 mm



**G-31720** *AKAHOSHI*  
**PRECHOPPER**  
 for micro-incisions, straight shafts, cross action  
 round handle  
 overall length 125 mm



**G-31722** *AKAHOSHI*  
**HYBRID COMBO PRECHOPPER**  
 for micro-incisions, cross action, straight  
 round handle  
 length of tip 5.3 mm  
 overall length 120 mm







**G-31724** *AKAHOSHI*  
**UNIVERSAL PRECHOPPER**  
for micro-incisions, cross action, straight  
round handle  
overall length 120 mm



**G-33440** *VON BARSEWISCH*  
**ANTERIOR CHAMBER FORCEPS**  
extra delicate  
8.5 mm angled shafts  
1.5 mm platform  
overall length 72 mm



**G-32165** *FECHNER*  
**IMPLANTATION FORCEPS**  
smooth curved shafts  
overall length 80 mm



**G-18935** *DODEN*  
**IMPLANTATION FORCEPS**  
curved  
delicate lens holding shafts  
overall length 110 mm





**G-18930** *SHEPARD*  
**IMPLANTATION FORCEPS**  
 curved, 1.4 mm disc-shaped tips  
 delicate lens holding shafts  
 overall length 120 mm



**G-31962** *T. KOHNEN*  
**IMPLANTATION FORCEPS**  
 silicone tube coated  
 10 mm angled shafts  
 overall length 107 mm



**G-18918** *DICK*  
**FIXATION AND HOLDING FORCEPS**  
 for Artisan/Verisyse IOL  
 with guide mark for lens maximum hold  
 and stability  
 18 gauge / 1.2 mm curved shaft  
 overall length 143



**G-18919** *DICK*  
**IOL HAPTIC EXPANDER**  
 for enclavation of iris-fixated IOLs  
 21 gauge / 0.8 mm curved shaft  
 overall length 140 mm



10

IOL IMPLANTATION · SILICONE COATED



**G-18944**

*T. NEUHANN*

**IMPLANTATION FORCEPS**

for retropupillary implantation of Iris-Claw-IOL  
0.9 mm wide holding surface  
20 gauge / 0.9 mm curved shaft  
overall length 143 mm

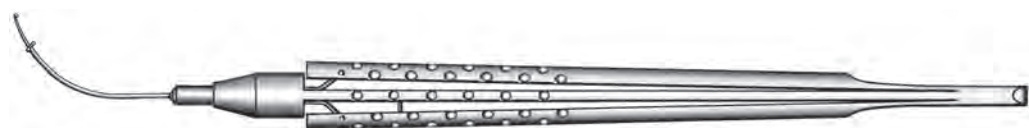

**G-18928**

*SEKUNDO*

**IMPLANTATION FORCEPS**

for retropupillary implantation of Iris-Claw-IOL  
20 gauge / 0.9 mm curved shaft with  
lens holding plate, three-point fixation  
and IOL centration guide mark  
6 mm titanium handle, blue-colored  
overall length 143 mm



**G-31902**

**FOLDER**

foldable IOL insertion forceps  
cross action  
6.5 mm concave jaws  
overall length 103 mm



**G-31903**

*SPALECK*

**FOLDER**

foldable IOL insertion forceps  
for silicone and acrylic IOLs  
angled shafts, concave jaws  
overall length 102 mm



G-31908

**FOLDER**

IOL folding forceps  
for easy pickup and folding acrylic IOLs  
overall length 105 mm



G-31994

*H.-R. KOCH*  
**PREFOLDER**

for foldable silicone, hydrogel or acrylic IOLs  
overall length 135 mm



G-31905

*H.-R. KOCH*  
**FOLDER**

for foldable 3-piece IOLs  
6.0 mm concave jaws  
overall length 92 mm



G-31901

**HOLDING FORCEPS**

for foldable IOLs  
highly polished round and smooth shafts  
overall length 108 mm



**G-18941**

*STROBEL*  
**HOLDING FORCEPS**  
for Pharmacia CeeOn Edge IOL  
overall length 110 mm

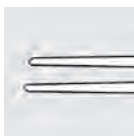

**G-32823**

**EXPLANTATION FORCEPS**  
for soft IOLs  
2.0 mm x 1.4 mm paddle tip with  
interlocking serrations and guide pin  
overall length 108 mm



**G-32997**

*SNYDER-OSHER*  
**IOL FORCEPS**  
to hold the IOL while cutting it inside  
the capsular bag  
2 mm long jaws with 0.5 mm serrated tips  
22 gauge / 0.7 mm lightly curved shaft  
overall length 99 mm



**G-18820**

*REMKY*  
**SUPERIOR RECTUS FORCEPS**  
angled  
1 x 2 teeth  
overall length 109 mm

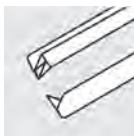

G-18800

*ELSCHNIG*  
**SUPERIOR RECTUS FORCEPS**  
 standard, straight  
 1 x 2 teeth  
 overall length 110 mm

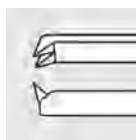

G-18795

*ELSCHNIG*  
**SUPERIOR RECTUS FORCEPS**  
 delicate, straight  
 1 x 2 teeth  
 overall length 100 mm

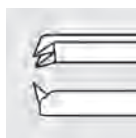

G-19105

*LEYDHECKER*  
**SUPERIOR RECTUS FORCEPS**  
 curved, tip width 0.8 mm  
 1 x 2 teeth, 1.1 mm  
 overall length 110 mm

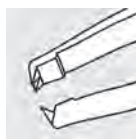

G-32335

*CASTROVIEJO*  
**SUPERIOR RECTUS FORCEPS**  
 angled with tying platform  
 1 x 2 teeth, 0.9 mm  
 overall length 100 mm

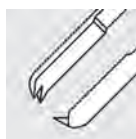

G-19112

*BANGERTER*  
**MUSCLE FORCEPS**  
 10 teeth  
 self retaining  
 overall length 100 mm



*SATTLER*

**MUSCLE FORCEPS**

with slide lock  
overall length 100 mm

**G-19120**

3 teeth, bulbous tip, right

**G-19125**

3 teeth, bulbous tip, left



**G-32350**

*TROELTSCH*

**NASAL FORCEPS**

serrated tips  
for packing and dressing during ENT procedures  
overall length 150 mm



**G-19107**

*ESSEN MODEL*

**CERCLAGE FORCEPS**

strongly curved  
3 mm platform with dual grooves  
overall length 104 mm



**G-33752**

*WATZKE*

**SPREADING FORCEPS**

to stretch silicone sleeves  
cross action handle and  
serrated tips  
overall length 115 mm



**G-33434**

*PFENNIGWERTH*

**HOLDING FORCEPS**

for vitreoretinal lenses  
curved with concave lens holding tips  
overall length 110 mm



G-33439

**SCLERAL PLUG FORCEPS**

cross action handle, angled jaws to securely hold plugs during insertion and removal  
overall length 105 mm



G-31570

**SCLERAL PLUG FORCEPS**

to securely hold plugs during insertion and removal  
overall length 100 mm



10

RETINAL (SCLERAL PLUG, RETINAL TACK)



**G-33432 SCLERAL PLUG**  
serrated,  
20 gauge / 0.9 mm



**G-33436 SCLERAL PLUG**  
to suture onto sclera  
20 gauge / 0.9 mm



**G-33435 SCLERAL PLUG**  
20 gauge / 0.9 mm



**G-33441 SCLERAL PLUG**  
23 gauge / 0.6 mm

G-33438

**FORCEPS**

for HEIMANN retinal tacks  
overall length 100 mm



G-33437T

**HEIMANN RETINAL TACK**

titanium  
- for single use only -

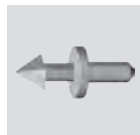



**G-37420** *BARTZ-SCHMIDT*  
**TROCAR CLOSURE FORCEPS**  
with function for bulbus fixation  
overall length 72 mm



**G-37430** **TROCAR FORCEPS**  
for trocar systems with groove  
overall length 110 mm



**G-33831** *REIMANN*  
**VITREORETINAL FORCEPS**  
for foreign body removal  
with retractable magnet and 3-prongs  
14 gauge / 2.1 mm straight shaft  
shaft length 35 mm  
overall length 138 mm

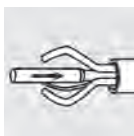

20 GAUGE

VITREORETINAL FORCEPS

20 gauge / 0.9 mm  
 6 mm and 8 mm diameter handles  
 titanium, blue-colored  
 overall length 155 mm

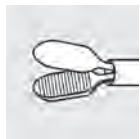

straight  
 serrated tips  
**G-36202** 6 mm handle

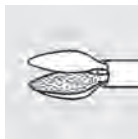

straight  
 textured tips  
**G-36206** 6 mm handle  
**G-36208** 8 mm handle

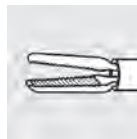

straight  
 serrated "crocodile" tips  
**G-36256** 6 mm handle  
**G-36258** 8 mm handle

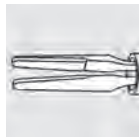

straight  
 silicone coated  
**G-36212** 6 mm handle  
**G-36214** 8 mm handle

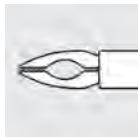

TANO  
 straight, serrated tips  
**G-36356** 6 mm handle  
**G-36358** 8 mm handle

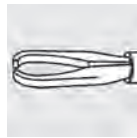

A. MUELLER  
 for retinal vessels / sheatotomy  
**G-36332** 6 mm handle

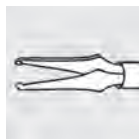

straight  
 grip tips  
**G-36216** 6 mm handle  
**G-36218** 8 mm handle

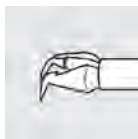

90° angle  
 pointed tips  
**G-36276** 6 mm handle  
**G-36278** 8 mm handle



NAITO  
 ILM  
**G-36316** 6 mm handle  
**G-36318** 8 mm handle

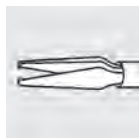

straight  
 endgripping, extra delicate  
 0.2 mm x 0.05 mm  
**G-36292** 6 mm handle  
**G-36294** 8 mm handle

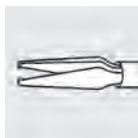

straight  
 endgripping, extra delicate  
 0.3 mm x 0.05 mm  
**G-36296** 6 mm handle  
**G-36298** 8 mm handle

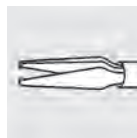

straight  
 endgripping, delicate  
 0.2 mm x 0.1 mm  
**G-36302** 6 mm handle  
**G-36304** 8 mm handle

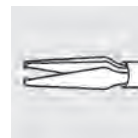

straight  
 endgripping  
 0.3 mm x 0.1 mm  
**G-36306** 6 mm handle  
**G-36308** 8 mm handle



10  
 VITREORETINAL 20 GAUGE

**20 GAUGE**

**VITREORETINAL FORCEPS**

20 gauge / 0.9 mm  
6 mm and 8 mm diameter handles  
titanium, blue-colored  
overall length 155 mm



90° angle  
membrane peeler  
**G-36226** 6 mm handle

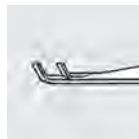

45° angle  
membrane peeler  
**G-36232** 6 mm handle

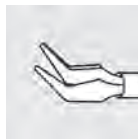

45° angle  
**G-36222** 6 mm handle



membrane peeler tips  
**G-36252** 6 mm handle  
**G-36254** 8 mm handle



curved  
membrane dissector  
**G-36266** 6 mm handle



45° angle  
membrane dissector  
**G-36272** 6 mm handle

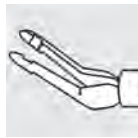

45° angle  
horizontal subretinal  
**G-36236** 6 mm handle



45° angle, vertical tips  
subretinal  
**G-36246** 6 mm handle  
**G-36248** 8 mm handle



angled, extra delicate  
3.0 mm tips  
**G-36336** 6 mm handle



angled, extra delicate  
4.5 mm tips  
**G-36326** 6 mm handle  
**G-36328** 8 mm handle



straight  
circular tips  
**G-36242** 6 mm handle

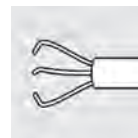

foreign body forceps  
**G-36262** 6 mm handle  
**G-36264** 8 mm handle

23 GAUGE

VITREORETINAL FORCEPS

23 gauge / 0.6 mm  
 6 mm and 8 mm diameter handles  
 titanium, blue-colored  
 overall length 155 mm

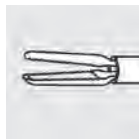

straight  
 serrated "crocodile" tips

**G-36342** 6 mm handle  
**G-36344** 8 mm handle

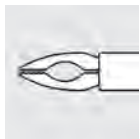

TANO  
 straight, serrated tips

**G-36362** 6 mm handle  
**G-36364** 8 mm handle

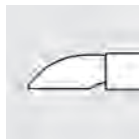

straight  
 endgripping, extra delicate  
 0.2 mm x 0.05 mm

**G-36282** 6 mm handle  
**G-36284** 8 mm handle

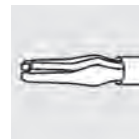

straight  
 grip tips

**G-36286** 6 mm handle  
**G-36288** 8 mm handle

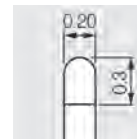

10

VITREORETINAL 23 & 25 GAUGE

25 GAUGE

VITREORETINAL FORCEPS

25 gauge / 0.5 mm  
 6 mm and 8 mm diameter handles  
 titanium, blue-colored  
 overall length 155 mm

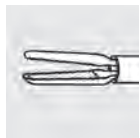

straight  
 serrated "crocodile" tips

**G-36322** 6 mm handle  
**G-36324** 8 mm handle

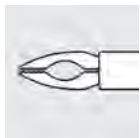

TANO  
 straight, serrated tips

**G-36366** 6 mm handle  
**G-36368** 8 mm handle

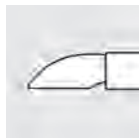

straight  
 endgripping, extra delicate  
 0.2 mm x 0.05 mm

**G-36312** 6 mm handle  
**G-36314** 8 mm handle



**ERGOLINE**

**ERGOLINE FORCEPS**

360° rotatable and interchangeable tips  
overall length 55 mm  
for Ergoline handpieces 6 mm and 8 mm diameters

**ERGOLINE HANDPIECE**

for Ergoline forceps  
blue-colored  
**G-36600** 6 mm titanium handpiece  
**G-36601** 8 mm titanium handpiece

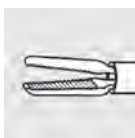

**ERGOLINE FORCEPS**  
straight  
serrated "crocodile" tips  
**G-36655** 20 gauge / 0.9 mm  
**G-36740** 23 gauge / 0.6 mm  
**G-36720** 25 gauge / 0.5 mm

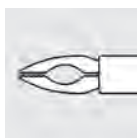

*TANO*  
**ERGOLINE FORCEPS**  
straight, serrated tips  
**G-36755** 20 gauge / 0.9 mm  
**G-36765** 23 gauge / 0.6 mm

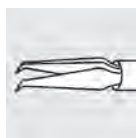
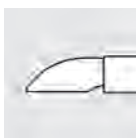

*NAITO*  
**ERGOLINE FORCEPS ILM**  
**G-36715** 20 gauge / 0.9 mm

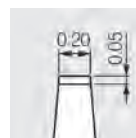
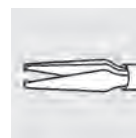

**ERGOLINE FORCEPS**  
endgripping  
extra delicate 0.2 mm x 0.05 mm  
**G-36690** 20 gauge / 0.9 mm  
**G-36680** 23 gauge / 0.6 mm  
**G-36710** 25 gauge / 0.5 mm

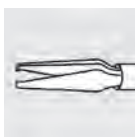

**ERGOLINE FORCEPS**  
endgripping  
extra delicate 0.3 mm x 0.05 mm  
**G-36695** 20 gauge / 0.9 mm

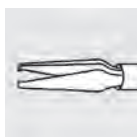

**ERGOLINE FORCEPS**  
endgripping  
delicate 0.2 mm x 0.1 mm  
**G-36700** 20 gauge / 0.9 mm

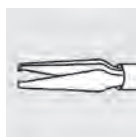

**ERGOLINE FORCEPS**  
endgripping  
delicate 0.3 mm x 0.1 mm  
**G-36705** 20 gauge / 0.9 mm

SINGLE-USE  
INTERCHANGEABLE FORCEPS  
AVAILABLE ON P. 219



10  
VITREORETINAL · INTERCHANGEABLE · ROTATABLE

**G-18680** *LAMBERT*  
**CHALAZION FORCEPS**  
 round, 9 mm inside diameter  
 solid and fenestrated plates  
 overall length 92 mm



**G-18670** *AYER*  
**CHALAZION FORCEPS**  
 round, 8 mm inside diameter  
 interlacing tips  
 solid and fenestrated plates  
 overall length 90 mm



*DESMARRES*  
**CHALAZION FORCEPS**  
 oval  
 solid and fenestrated plates  
**G-18685** 20 mm, overall length 88 mm  
**G-18690** 25 mm, overall length 90 mm  
**G-18695** 31 mm, overall length 95 mm



**G-18700** *CAUER*  
**CHALAZION FORCEPS**  
 oval, 13 mm x 11 mm inside diameter  
 interlacing serrated tips  
 solid and fenestrated plates  
 overall length 99 mm



**G-18710** *LORDAN*  
**CHALAZION FORCEPS**  
 triangular, 13 mm x 8 mm inside diameter  
 solid and fenestrated plates  
 overall length 95 mm



**G-18715** *BERKE*  
**PTOSIS FORCEPS**  
 22 mm long serrated tips  
 slide lock mechanism  
 overall length 110 mm



10

CHALAZION · PTOSIS

*HARTMANN*  
**MOSQUITO FORCEPS**  
serrated  
18 mm jaws  
overall length 100 mm  
straight  
G-18170  
G-18171 curved



*HALSTEAD*  
**MOSQUITO FORCEPS**  
serrated  
25 mm jaws  
overall length 125 mm  
straight  
G-18180  
G-18181 curved

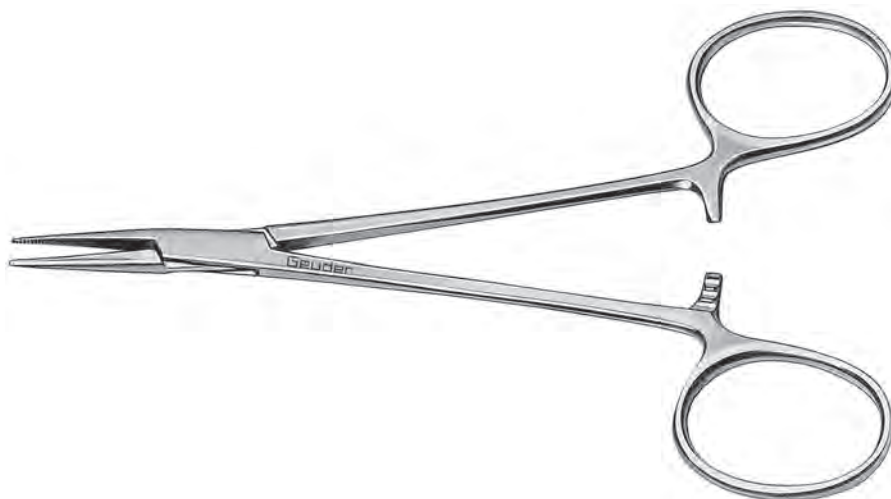

*HALSTEAD*  
**MOSQUITO FORCEPS**  
1 x 2 teeth  
serrated  
25 mm jaws  
overall length 125 mm  
straight  
G-18185  
G-18182 curved





**G-18160** *BACKHAUS*  
**TOWEL FORCEPS**  
overall length 90 mm



**G-33200** *SCHAEDEL*  
**TOWEL FORCEPS**  
overall length 90 mm



**G-18190** *DIEFFENBACH*  
**SERREFINE**  
straight, overall length 35 mm



**G-18195** *DIEFFENBACH*  
**SERREFINE**  
curved, overall length 35 mm



**G-31420** *DIEFFENBACH*  
**SERREFINE**  
straight, overall length 50 mm



**G-31415** *DIEFFENBACH*  
**SERREFINE**  
curved, overall length 50 mm



**G-18197** **SERREFINE**  
extra delicate, overall length 30 mm



## NEEDLE HOLDERS





*BARRAQUER***NEEDLE HOLDER**

10 mm delicate jaws  
0.8 x 0.55 mm tip  
overall length 120 mm  
curved, without lock  
curved, with lock

**G-17500**  
**G-17501**

*BARRAQUER***NEEDLE HOLDER**

10 mm delicate jaws  
0.8 x 0.45 mm tip  
overall length 120 mm  
curved, without lock  
curved, with lock

**G-17505**  
**G-17506**

*JACOBI***NEEDLE HOLDER**

5 mm extra delicate jaws  
1.0 x 0.5 mm tips  
overall length 115 mm  
straight, without lock  
straight, with lock

**G-17451**  
**G-17453**

*JACOBI***NEEDLE HOLDER**

5 mm extra delicate jaws  
1.0 x 0.5 mm tips  
overall length 115 mm  
curved, without lock  
curved, with lock

**G-17450**  
**G-17452**

*BARRAQUER***NEEDLE HOLDER**

7.5 mm extra delicate jaws  
0.6 x 0.3 mm tip  
overall length 105 mm  
straight, without lock  
straight, with lock

**G-17461**  
**G-17463**

*BARRAQUER***NEEDLE HOLDER**

7.5 mm extra delicate jaws  
0.6 x 0.3 mm tip  
overall length 105 mm  
curved, without lock  
curved, with lock

**G-17460**  
**G-17462**



*BARRAQUER-TROUTMAN*  
**NEEDLE HOLDER**

10 mm extra delicate jaws  
0.8 x 0.6 mm tip  
handle diameter 6 mm  
overall length 100 mm  
straight, without lock  
straight, with lock

**G-32260**  
**G-32261**



*BARRAQUER-TROUTMAN*  
**NEEDLE HOLDER**

10 mm extra delicate jaws  
0.8 x 0.6 mm tip  
handle diameter 6 mm  
overall length 100 mm  
curved, without lock  
curved, with lock

**G-17535**  
**G-17530**



*BARRAQUER*  
**NEEDLE HOLDER**

11 mm delicate jaws  
0.9 x 0.8 mm tips  
handle diameter 8 mm  
overall length 140 mm  
curved, without lock  
curved, with lock

**G-17510**  
**G-17511**



*BARRAQUER*  
**NEEDLE HOLDER**

11 mm extra delicate jaws  
0.9 x 0.55 mm tips  
handle diameter 8 mm  
overall length 140 mm  
curved, without lock  
curved, with lock

**G-17515**  
**G-17516**



*BARRAQUER***NEEDLE HOLDER**

11 mm delicate jaws  
1.1 x 0.75 mm tips  
handle diameter 10 mm  
overall length 140 mm  
curved, without lock  
G-17525  
curved, with lock

G-17520

G-17525



G-32315

*BARRAQUER***NEEDLE HOLDER**

curved, without lock  
8 mm standard jaws  
1.2 x 0.8 mm tips  
original model with longitudinal groove  
handle diameter 10 mm  
overall length 130 mm



G-32320

G-32321

*BARRAQUER***NEEDLE HOLDER**

12 mm standard jaws  
1.6 x 1.0 mm tips  
handle diameter 10 mm  
overall length 140 mm  
curved, without lock  
curved, with lock

*CASTROVIEJO*  
**NEEDLE HOLDER**

short model  
9 mm extra delicate jaws  
0.9 x 0.55 mm tips  
overall length 90 mm  
straight, without lock  
straight, with lock

**G-17545**  
**G-17540**



*CASTROVIEJO*  
**NEEDLE HOLDER**

10.5 mm delicate jaws  
1.5 x 0.8 mm tips  
overall length 140 mm  
straight, without lock  
straight, with lock

**G-17560**  
**G-17565**



*CASTROVIEJO*  
**NEEDLE HOLDER**

10.5 mm delicate jaws  
1.5 x 0.8 mm tips  
overall length 140 mm  
curved, without lock  
curved, with lock

**G-17570**  
**G-17575**



**COMBINED NEEDLE HOLDER / SCISSORS**  
curved 12 mm blades with  
3 mm needle holder and tying platform  
used to hold, place and cut fine suture material  
overall length 125 mm



**G-17440**

without lock

**G-17441**

with lock



**G-32949**

*HATTENBACH*

**HYBRID NEEDLE HOLDER**

angled, for the anterior chamber  
25 gauge / 0.5 mm  
overall length 90 mm



for use in combination with  
hybrid tying forceps G-32947



*KALT*  
**NEEDLE HOLDER**

standard jaws  
serrated, with longitudinal groove  
thumb rest and catch  
overall length 135 mm

**G-17610**

straight, cross serrated jaws

**G-17615**

curved, cross serrated jaws



*ARRUGA*

**NEEDLE HOLDER**

14 mm heavy jaws  
thumb rest and catch  
overall length 140 mm  
straight, smooth jaws  
curved, smooth jaws

**G-17640**

**G-17645**

**G-17660**

*HEIDELBERG MODEL*

**NEEDLE HOLDER**

straight  
14 mm heavy jaws  
with ratchet lock  
overall length 125 mm



**G-17650**

*BOYNTON*

**NEEDLE HOLDER**

straight  
with ratchet lock  
overall length 120 mm



**G-17665**

*ROHRSCHEIDER*

**NEEDLE HOLDER**

straight  
13 mm heavy jaws  
1.3 x 1.5 mm tips  
overall length 100 mm





**G-19270** *BARRAQUER*  
**RAZOR BLADE HOLDER**  
flat handle  
overall length 110 mm



**G-19320** *CASTROVIEJO*  
**RAZOR BLADE HOLDER**  
6 mm round handle  
overall length 120 mm



**G-19330** *TROUTMAN*  
**RAZOR BLADE HOLDER**  
straight  
6 mm round handle  
overall length 95 mm



**G-19300** **RAZOR BLADES**  
10 pcs. per box



**G-18150** **HOLDER FOR ABSORBENT STRIPS**  
serrated  
to secure sterile absorbent swabs (G-18127)  
overall length 175 mm



MANIPULATORS  
 CHOPPERS, FIXATION RINGS  
 HOOKS, SPATULAS  
 LENS LOOPS



FIXATION RINGS .....	149
NUCLEUS CHOPPERS .....	151
LENS & NUCLEUS MANIPULATORS .....	155
IRIS HOOKS .....	157
NUCLEUS SPATULAS .....	158
CAPSULE POLISHERS .....	160
LENS LOOPS .....	161
ORBITAL SPATULAS .....	162
CYCLODIALYSIS SPATULAS .....	164
IRIS SPATULAS .....	165
FEMTOSECOND LASER MANIPULATORS .....	169
STRABISMUS HOOKS .....	173
MEMBRANE PEELERS AND SPATULAS .....	175



**G-37440**

*HATTENBACH*

**GLOBE FIXATION RING**

for transconjunctival PPV  
12 mm inside diameter



**G-33755**

*THORNTON*

**FIXATION RING**

16 mm inside diameter  
12 atraumatic teeth



**G-31490**

*FINE-THORNTON*

**FIXATION RING**

for clear cornea and refractive procedures  
16 mm inside diameter, 10 mm opening  
12 atraumatic teeth



**G-31491**

*FINE-THORNTON*

**FIXATION RING**

for clear cornea and refractive procedures  
13 mm inside diameter, 10 mm opening  
9 atraumatic teeth





**G-33757** *FINE-THORNTON*  
**FIXATION RING**  
for clear cornea and refractive procedures  
swivel handle  
16 mm inside diameter, 10 mm opening  
12 atraumatic teeth



**G-33758** *FINE-THORNTON*  
**FIXATION RING**  
for clear cornea and refractive procedures  
swivel handle  
13 mm inside diameter, 10 mm opening  
9 atraumatic teeth



**G-33759** *FINE-THORNTON*  
**FIXATION RING**  
for clear cornea and refractive procedures  
swivel handle  
13 mm inside diameter, 10 mm opening  
9 atraumatic teeth



**G-37425** **FIXATION, HOLDING AND MEASURING INSTRUMENT**  
for trocar system, radius 3.5 mm



*FLIERINGA*  
**SCLERAL FIXATION RING**

- G-15065** 15 mm
- G-15070** 16 mm
- G-15075** 17 mm
- G-15080** 18 mm
- G-15085** 19 mm
- G-15090** 20 mm

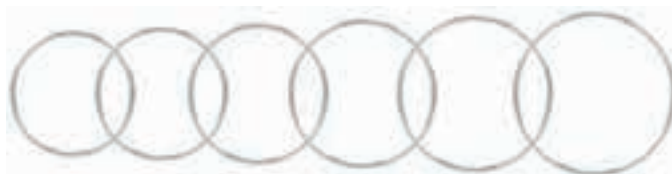

**G-32505**

*THOMAS NEUHANN*  
**NUCLEUS DIVIDING HOOK**  
for vertical chopping techniques  
0.5 mm wide fine tip  
overall length 108 mm



**G-31500**

*MIYOSHI*  
**NUCLEUS DIVIDING HOOK**  
1 mm tip, 0.6 mm inner edge  
overall length 104 mm  
universal

**G-31501**

for use in left hand

**G-31502**

for use in right hand



universal  
G-31500



left hand  
G-31501



right hand  
G-31502

**G-31504**

*VÖLCKER*  
**NUCLEUS DIVIDING HOOK**  
for narrow pupils  
with outer notch to push iris aside  
1.5 mm inner edge  
overall length 104 mm



**G-31503**

*ZIRM*  
**NUCLEUS DIVIDING HOOK**  
1.5 mm inner edge  
overall length 104 mm

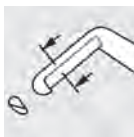

G-32500

TOBIAS NEUHANN

**CHOPPER**

paddle shape nucleus divider  
0.5 mm wide tip  
overall length 108 mm



side view

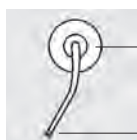

front view

handle

tip

G-32282

AGARWAL

**KARATE PHACO CHOPPER**

0.9 mm long tip  
0.6 mm inner edge  
overall length 104 mm



NUCLEUS CHOPPERS

12

G-31505

G-31506

HAEFLIGER

**NUCLEUS DIVIDING HOOK**

to crack, chop and manipulate lenses  
1.0 mm triangular tip  
0.7 mm inner sharp hook  
overall length 104 mm

for use in right hand

for use in left hand



G-31507

NAGAHARA

**NUCLEUS DIVIDING HOOK**

for horizontal chopping techniques  
1.5 mm long tip  
0.9 mm inner edge  
overall length 98 mm





**G-32501**

THOMAS NEUHANN  
**NUCLEUS ROTATOR** and  
TOBIAS NEUHANN  
**CHOPPER**

combination of  
horizontal Y-shaped nucleus rotator and  
paddle shaped nucleus divider  
overall length 119 mm



like G-32160



like G-32500

**G-32168**

THOMAS NEUHANN  
**SPATULA** and  
NAGAHARA  
**NUCLEUS DIVIDING HOOK**

combination of  
0.5 mm wide phaco spatula and  
horizontal phaco chopper  
overall length 116 mm



like G-16189



like G-31507

**G-32161**

THOMAS NEUHANN  
**NUCLEUS ROTATOR AND DIVIDING HOOK**

combination of  
horizontal Y-shaped nucleus rotator and  
vertical phaco chopper  
overall length 117 mm



like G-32160



like G-32505

**G-32164**

THOMAS NEUHANN  
**SPATULA AND NUCLEUS DIVIDING HOOK**

combination of  
0.5 mm wide phaco spatula and  
vertical phaco chopper  
overall length 125 mm



like G-16189



like G-32505

G-32162

*THOMAS NEUHANN*  
**IRIS HOOK AND NUCLEUS DIVIDING HOOK**  
combination of push-pull iris hook and  
*NEUHANN* vertical chopper  
overall length 120 mm



like G-16175



like G-32505

G-32169

*T. KOHNEN*  
**IRIS HOOK AND NUCLEUS DIVIDING HOOK**  
combination of push-pull iris hook and  
*NAGAHARA* horizontal chopper  
overall length 114 mm



like G-16175



like G-31507

G-16181

G-16182

*LIEBERMANN*  
**MICROFINGER**  
Nucleus Manipulator  
1.5 mm curved microfinger  
overall length 103 mm  
for use in right hand  
for use in left hand



G-31727

*AKAHOSHI*  
**NUCLEUS SUSTAINER**  
to manipulate and sustain nucleus  
used in combination with prechopper  
0.5 mm ball tip  
1.8 mm angled  
overall length 100 mm



G-16185

*DRYSDALE*

**NUCLEUS MANIPULATOR AND  
ANTERIOR CAPSULE POLISHER**

to manipulate, rotate, and divide the nucleus  
1.0 mm x 1.5 mm paddle shaped tip  
overall length 100 mm



G-32160

*THOMAS NEUHANN*

**NUCLEUS ROTATOR**

horizontal Y-shaped rotator and manipulator  
0.15 mm diameter tip  
overall length 104 mm



G-32034

*HENNIG / FRIEDRICH*

**LENS EXTRACTION HOOK**

(Hefri Hook)  
overall length 105 mm



G-32550

*MAINZ MODEL*

**LENS MANIPULATOR**

straight  
0.15 mm diameter tip  
overall length 114 mm



G-32556

*MAINZ MODEL*

**MANIPULATOR**

vaulted  
0.15 mm diameter tip  
overall length 109 mm



*JACOBI*  
**LENS MANIPULATOR**  
vaulted  
overall length 99 mm  
for 0.3 mm IOL hole  
**G-16160**  
**G-16161**



*SINSKEY*  
**LENS MANIPULATION HOOK**  
for 0.2 mm IOL hole  
10 mm angled shaft  
overall length 103 mm  
flat handle  
**G-16166**  
**G-16167**



**G-32557**  
*BREMEN MODEL*  
**LENS MANIPULATOR**  
vertical Y-hook  
0.15 mm diameter tip  
overall length 116 mm



**G-32555**  
*RENTSCH*  
**LENS MANIPULATOR AND HOOK**  
straight  
0.18 mm diameter boat hook  
overall length 137 mm



**G-32530**  
*FRANKFURT MODEL*  
**MANIPULATOR**  
straight  
0.18 mm diameter lens hook  
overall length 137 mm



IOL MANIPULATORS · POSITION HOOKS

12

G-32275

*ZIRM*  
**LENS LOOP MANIPULATOR**  
vertical Y-hook  
0.15 mm diameter tip  
overall length 108 mm



G-32276

*LESTER*  
**LENS LOOP MANIPULATOR**  
vaulted  
0.25 mm diameter tip  
overall length 102 mm



G-16169

*TANDOGAN*  
**EXPLANTATION HOOK**  
for IOL  
0.2 mm diameter tip  
overall length 103 mm



G-16210

*HIRSCHMANN*  
**LENS SPATULA**  
0.6 mm wide spatula with  
0.2 mm notches  
overall length 104 mm



G-16175

*DARDENNE*  
**IRIS HOOK AND LENS MANIPULATOR**  
push-pull tip  
overall length 105 mm



G-32227

LUND

**IRIS HOOK**

0.8 mm collar button  
overall length 105 mm



G-16205

BONN MODEL

**IRIS HOOK**

extra delicate  
0.15 mm diameter hook  
overall length 111 mm



G-31911

FRANKFURT MODEL

**IRIS HOOK AND LENS MANIPULATOR**

0.65 mm collar button  
overall length 135 mm



G-16191

STEINMETZ

**SPATULA**

for manual lens fragmentation  
1 mm wide nucleus bisector  
for use in left hand  
overall length 110 mm



G-16193

SPIRIG

**SPATULA**

for manual lens fragmentation  
0.5 mm wide nucleus bisector  
overall length 110 mm



**G-32728**

*RENTSCH*  
**SPATULA**

12 mm long spatula  
tapered from 0.6 mm to 0.3 mm  
overall length 118 mm



**G-32005**

*ENGELS*  
**PHACO SPOON**

0.6 mm wide round spatula  
overall length 86 mm



**G-32007**

*D. D. KOCH*  
**PHACO SPATULA**

curved with notches  
duckbill 0.5mm wide tip  
overall length 105 mm



**G-32523**

*AMON*  
**PHACO SPATULA**

paddle-shaped tip  
0.8 mm wide x 1.6 mm long  
0.2 mm thick  
overall length 103 mm



**G-16189**

**SPATULA**

12 mm spatula  
angled, 45°  
overall length 108 mm

**G-16190**

0.5 mm wide x 0.25 mm thick  
1.0 mm wide x 0.25 mm thick



G-32724

*SEKUNDO*  
**ENCLAVATION SPATULA**  
for retropupillary implantation of  
Iris-Claw IOL  
14 mm long spatula  
tapered from 0.75 mm to 0.3 mm  
overall length 118mm



G-31378

*ANIS*  
**BALL CAPSULE POLISHER**  
1.5 mm diameter hemisphere tip  
textured  
overall length 113 mm



G-32563

*RENTSCH*  
**CAPSULE POLISHING CURETTE**  
angled 135°  
1.5 mm diameter tip  
anterior and posterior semi-sharp edges  
overall length 108 mm

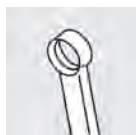

G-32564

*RENTSCH*  
**CAPSULE POLISHING CURETTE**  
angled 90°  
1.5 mm diameter tip  
anterior and posterior semi-sharp edges  
overall length 110 mm





G-15620

*ARLT*  
**LENS LOOP**  
serrated, curved  
3.5 mm wide  
overall length 135 mm



G-15630

*SNELLEN*  
**LENS LOOP**  
smooth, curved  
3.5 mm wide  
overall length 135 mm



G-15640

*WEBER*  
**LENS LOOP**  
small  
4 mm wide  
overall length 130 mm



G-15645

*WEBER*  
**LENS LOOP**  
large  
5 mm wide  
overall length 135 mm



G-15635

*SPIRIG*  
**LENS LOOP**  
for manual lens fragmentation  
serrated, curved  
2.2 mm wide  
overall length 135 mm





*BANGERTER*  
**SPATULA**  
lightly curved  
overall length 139 mm

**G-15720**

6 mm wide

**G-15725**

10 mm wide

**G-15730**

12 mm wide



**G-15731**

*BEHRENS-BAUMANN*  
**ORBITAL SPATULA**  
with aspiration  
10 mm wide, lightly curved  
overall length 137 mm



*SAUTTER*  
**ORBITAL SPATULA**  
overall length 142 mm  
**G-15740** 22 x 13 mm curved plate  
**G-15745** 22 x 16 mm curved plate  
**G-15750** 22 x 19 mm curved plate

**G-15740**

22 x 13 mm curved plate

**G-15745**

22 x 16 mm curved plate

**G-15750**

22 x 19 mm curved plate



**G-32445**

*HAMBURG MODEL*  
**ORBITAL SPATULA**  
18 x 12 mm curved plate  
overall length 145 mm

18 x 12 mm curved plate

overall length 145 mm



**G-32446**     **ORBITAL SPATULA**  
18 x 8 mm curved plate  
overall length 145 mm



**G-15758**     **KERATOPLASTY  
SPATULA**  
perforated



**G-32727**     *BINKHORST*  
**SYNECHIAE SPATULA**  
10 mm long, semi-sharp  
extra delicate  
overall length 129 mm



**G-15477**     *CASTROVIEJO*  
**SYNECHIAE SPATULA**  
7 mm long, semi-sharp  
0.5 mm wide  
overall length 86 mm



**G-15475** *CASTROVIEJO*  
**CYCLODIALYSIS SPATULA**  
double ended, blunt  
10 and 15 mm long  
overall length 134 mm



**G-15470** *ELSCHMIG*  
**CYCLODIALYSIS SPATULA**  
10 mm long, blunt  
1.2 mm wide  
overall length 127 mm



**G-15480** *CASTROVIEJO*  
**CYCLODIALYSIS SPATULA**  
10 mm long, blunt  
0.7 mm wide  
overall length 129 mm



**G-15485** *CASTROVIEJO*  
**CYCLODIALYSIS SPATULA**  
15 mm long, blunt  
0.7 mm wide  
overall length 129 mm

G-15400

*WECKER*  
**IRIS SPATULA**

slim  
1.5 mm wide, lightly curved  
overall length 129 mm



G-15405

*WECKER*  
**IRIS SPATULA**

wide  
2.5 mm wide, lightly curved  
overall length 132 mm



G-31990

*WECKER*  
**IRIS SPATULA**

conical  
0.9 mm wide, lightly curved  
overall length 134 mm



G-15390

*FRANKFURT MODEL*  
**IRIS SPATULA**

0.9 mm wide, curved  
overall length 125 mm



G-15391

*FRANKFURT MODEL*  
**IRIS SPATULA**

extra delicate  
0.25 mm wide, curved  
overall length 125 mm



G-32729

**IRIS SPATULA**

extra delicate, conical  
7 mm long spatula, angled  
tapers from 0.5 mm to 0.3 mm  
overall length 114 mm



G-31975

*BANGERTER*  
**IRIS SPATULA**

round handle  
8 mm long spatula, angled  
overall length 118 mm

G-31980

1.0 mm wide

G-31985

1.5 mm wide

G-31985

2.0 mm wide



G-15360

*BANGERTER*  
**IRIS SPATULA**

flat handle  
8 mm long spatula, angled  
overall length 125 mm

G-15365

1.0 mm wide

G-15370

1.5 mm wide

G-15370

2.0 mm wide



G-15755

*ESSEN MODEL*  
**SPATULA**

10 mm wide  
25 mm angled, flat  
overall length 149 mm



IRIS SPATULAS

12



**G-15757** *GIESSEN MODEL*  
**SPATULA AND RETRACTOR**  
9 mm wide  
angled, concave  
overall length 162 mm



**G-15780** *WELLS*  
**ENUCLEATION SPOON**  
overall length 147 mm



**G-33912** *ZIRM*  
**LASIK CORNEAL PROTECTOR**  
7.0 x 2.5 mm corneal shield  
overall length 120 mm



**G-33930** *THOMAS NEUHANN*  
**LASIK SPATULA**  
with beveled blunt tip  
rounded anterior and  
flat posterior surface  
for lifting the corneal flap  
overall length 106 mm



G-33935

*RAU*

**LASEK SPATULA**

5.5 mm long spatula  
for repositing and smoothing  
the epithelial flap after laser ablation  
overall length 116 mm



G-38607

**DESCEMET INCISION HOOK**

0.2 mm diameter blunt tip  
for marking the area of Descemetorhexis  
in recipient's eye  
overall length 103 mm



G-38608

**DESCEMET SCRAPER**

1 mm semi-circular tip  
for scraping the recipient Descemet's  
membrane  
overall length 103 mm



G-38622

*SZURMAN*

**DMEK PREPARATION SPATULA**

disc-shaped spatula  
2.5 mm diameter, blunt  
for removal of Descemet's membrane from graft  
overall length 121 mm



G-38604

*THOMAS NEUHANN*

**ENDOTHELIAL INSERTION SPATULA**

with teflon insert, angled 145°, 4 x 2 mm  
for easy insertion of donor lamellar button  
with notched tip for "pull-through" technique  
overall length 104 mm  
(used with G-38606)





G-33966

*DICK*

**FEMTOCATARACT SPATULA**

double ended with round semi-sharp tips  
for easy opening of femto incisions  
spatula 2.5 mm flattened, 0.65 mm wide  
for main and sideport incisions  
knife 90° angled, 0.9 mm wide  
for arcuate incisions  
overall length 100 mm



G-33967

*BREYER*

**FEMTOCATARACT SPATULA**

angled  
1 mm blunt round tip  
for opening femto incisions  
overall length 100 mm



G-33968

*HOFFMANN*

**FEMTOCATARACT NUCLEUS ROTATOR  
AND CHOPPER**

horizontal Y-shaped rotator, 0.75 mm wide  
and 1 mm "Quick Chop" tip  
overall length 120 mm



G-33950

*CHANSUE*

**FEMTO DOUBLE INSTRUMENT**

blunt spoon-shaped lenticule spatula  
1.25 mm wide, vaulted and  
hook, 2 mm long, angled  
overall length 115 mm  
to open the incision, delineate the edge  
of the lenticules and separate the interfaces  
during SMILE procedures



G-33952

CHANSUE

**FEMTO DOUBLE INSTRUMENT**

conical lenticule spatula, 9 mm long, vaulted hook, 2 mm long, angled overall length 115 mm to open the incision, delineate the edge of the lenticules and separate the interfaces during SMILE procedures



G-33954

GUELL

**FEMTO DOUBLE INSTRUMENT**

1.25 mm wide spoon-shaped spatula, straight 2 mm long hook, angled overall length 113 mm to open the incision, delineate the edge of the lenticules and separate the interfaces during SMILE procedures



G-33940

BLUM

**FEMTO-LASIK ROUND SPOON**

spoon-shaped spatula, 1.25 mm wide semi-sharp, bevel up, vaulted overall length 105 mm to undermine, lift and reposit LASIK flaps created with a femtosecond laser



G-33942

BREYER

**FEMTO-LASIK DOUBLE-ENDED INSTRUMENT**

combination of BLUM spoon-shaped spatula, semi-sharp and hook with 1 mm inner edge (one blunt and one slightly sharp edge) overall length 115 mm



**G-33427**

*PFAEFFL*

**FEMTO FLAP LIFTER**

double ended, both ends blunt  
10.5 mm conical v-shaped hook, curved and  
1.5 mm modified *SINSKEY* hook  
overall length 115 mm  
for finding the flap edge, lifting, and retreating it



**G-33943**

*PFAEFFL*

**FEMTO FLAP LIFTER**

double ended  
10.5 mm conical v-shaped hook, straight and  
1.5 mm modified *SINSKEY* hook  
overall length 115 mm  
for finding the flap edge, lifting and retreating it



**G-33958**

*PFAEFFL-BREYER*

**FEMTO FLAP LIFTER**

double ended  
10.5 mm conical v-shaped hook, curved  
with double bevel tip and  
1.5 mm modified *SINSKEY* hook  
overall length 115 mm  
for finding the flap edge, lifting and retreating it



**G-33959**

*BREYER*

**FEMTO-LASIK HOOK INSTRUMENT**

angled  
1.3 mm wide scraper hook  
to delineate and remove the lenticule  
overall length 105 mm



G-33944

KOHNEN

**FEMTO-LASIK DOUBLE-ENDED INSTRUMENT**

11 mm long x 0.5 mm wide spatula and  
2 mm modified *SINSKEY* hook, blunt tip  
overall length 120 mm



G-37450

BONN MODEL

**SUTURE TOOL**

for scleral sutures



G-19137

CUEPPERS

**STRABISMUS MUSCLE TUCKER**

15 mm scale, for muscle stretching  
serrated J-shaped tendon hook to  
prevent the muscle from slipping

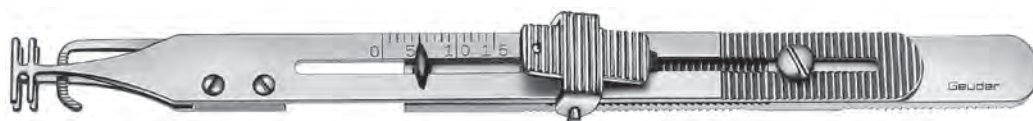

G-32726

MUENSTER MODEL

**SUTURE HOOK**

hook 5 mm  
overall length 149 mm





**G-15799** *GRAEFE*  
**STRABISMUS HOOK**  
short, 5 mm  
overall length 130 mm



**G-15800** *GRAEFE*  
**STRABISMUS HOOK**  
small, 8 mm  
overall length 131 mm



**G-15805** *GRAEFE*  
**STRABISMUS HOOK**  
medium, 10 mm  
overall length 133 mm



**G-15810** *GRAEFE*  
**STRABISMUS HOOK**  
large, 12 mm  
overall length 137 mm



**G-32915** *HAMBURG MODEL*  
**STRABISMUS HOOK**  
10 mm long  
slim 1 mm diameter hook  
overall length 135 mm



**G-15830** *MALBRAN*  
**STRABISMUS HOOK**  
9.5 mm serrated hook with right-angle knob  
to prevent muscle slippage  
overall length 140 mm



**G-15820** *BONN MODEL*  
**STRABISMUS HOOK**  
11 mm  
overall length 143 mm



**G-15821** *BONN MODEL*  
**STRABISMUS HOOK**  
11 mm retinal detachment hook  
with 1.0 mm hole  
overall length 143 mm



**G-32905** *BONN MODEL*  
**STRABISMUS HOOK**  
curved, tenotomy hook  
overall length 145 mm



**G-32920** *JAMESON*  
**STRABISMUS HOOK**  
11 mm, with bulbous tip  
overall length 125 mm

**G-37435**

*HATTENBACH*

**HORSESHOE-HOOK**

to pull the trocars off the lance  
and to remove the trocars from the sclera  
overall length 98 mm



**G-37551**

*BARTZ-SCHMIDT*

**ILM-SCRAPER**

20 gauge / 0.9 mm  
diamond dusted tip

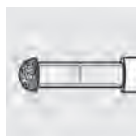

**MEMBRANE SPATULAS**



angled at 1.5 mm

**G-37530** 20 gauge / 0.9 mm



angled at 2 mm and 4 mm

**G-37535** 20 gauge / 0.9 mm



subretinal pick, angled at 4 mm

**G-37545** 20 gauge / 0.9 mm



*LUCKE*  
curved

**G-37515** 20 gauge / 0.9 mm



2.5 mm angled

**G-37525** 20 gauge / 0.9 mm



angled at 1 mm, long rakes

**G-37570** 20 gauge / 0.9 mm

**MEMBRANE PEELERS**



1.0 mm angled

**G-37500** 20 gauge / 0.9 mm

**G-37503** 23 gauge / 0.6 mm



*MORRIS-KROLL*

1.5 angled

**G-37505** 20 gauge / 0.9 mm



0.65 mm angled  
black chromium

**G-37506** 20 gauge / 0.9 mm



0.4 mm, recessed, angled  
black chromium

**G-37511** 20 gauge / 0.9 mm

**G-37512** 23 gauge / 0.6 mm

**G-37513** 25 gauge / 0.5 mm





## SCLERAL DEPRESSORS LOCALIZERS







**G-32152**     *LAQUA*  
**SCLERAL DEPRESSOR**  
with pocket clip  
3 x 1.8 mm teardrop-shaped tip  
overall length 128 mm



**G-32150**     *LAQUA*  
**SCLERAL DEPRESSOR**  
double-ended with pocket clip  
3 x 1.8 mm teardrop-shaped tip  
2 mm diameter scleral marker  
overall length 134 mm



**G-32153**     *LUCKE*  
**SCLERAL DEPRESSOR**  
with pocket clip  
3.8 x 2.0 mm teardrop-shaped tip  
overall length 128 mm



**G-32027**     *KREISSIG*  
**SCLERAL DEPRESSOR**  
double-ended with pocket clip  
conical tip with 2.4 mm diameter  
and 6.0 mm bar  
overall length 128 mm



**G-15710** *MEYER-SCHWICKERATH*  
**LOCALIZER AND SCLERAL DEPRESSOR**  
 for fixation and rotation



**G-32715** *SCHOCKET*  
**SCLERAL DEPRESSOR**  
 double-ended with pocket clip  
 3 x 2 mm teardrop tip and  
 6.0 mm bar  
 overall length 132 mm



**G-32714**  
**SCLERAL DEPRESSOR**  
 double-ended  
 2 mm and 4 mm diameter  
 diamond dusted tips  
 overall length 120 mm

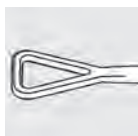

**G-37445** *HATTENBACH*  
**TRIANGLE SCLERAL DEPRESSOR**  
 for gentle buckling and firm grip without the risk of rupture  
 overall length 133 mm

SCLERAL DEPRESSORS · LOCALIZERS

## PROBES DILATORS





**G-150301** *WILDER*  
**LACRIMAL PROBE**  
delicate, long taper  
0.45 mm tip diameter  
overall length 104 mm



**G-150302** *WILDER*  
**LACRIMAL PROBE**  
medium, medium taper  
0.50 mm tip diameter  
overall length 104 mm



**G-150303** *WILDER*  
**LACRIMAL PROBE**  
strong, short taper  
0.55 mm tip diameter  
overall length 104 mm



**G-150401** *WILDER*  
**LACRIMAL PROBE**  
slim  
delicate, long taper  
0.30 mm tip diameter  
overall length 95 mm



**G-150402** *WILDER*  
**LACRIMAL PROBE**  
slim  
medium, medium taper  
0.35 mm tip diameter  
overall length 95 mm



**G-150403** *WILDER*  
**LACRIMAL PROBE**  
slim  
strong, short taper  
0.40 mm tip diameter  
overall length 95 mm



**G-15020** *GIESSEN MODEL*  
**LACRIMAL PROBE**  
11 mm tapered shaft, angled  
0.4 mm tip width  
overall length 77 mm



*KELLNAR*  
**RETROGRADE PROBE**  
 for canalicular repair  
 0.5 mm suture hole  
 overall length 95 mm  
 right  
 left



**G-15050**  
**G-15055**



**G-15095**  
**PIGTAIL PROBE**  
 double-ended  
 for canalicular repair  
 with 0.4 mm suture holes  
 overall length 140 mm



**G-15096**  
**PIGTAIL PROBE**  
 double-ended  
 for canalicular repair  
 with 1.0 mm suture hooks  
 overall length 140 mm



**PROBE FOR STROMAL CHANNEL**  
 for corneal implants in patients with  
 keratoconus  
 overall length 115 mm  
 bent to the left  
 bent to the right



**G-37602**  
**G-37604**





*BOWMAN*  
**LACRIMAL PROBE**  
cylindrical, silver  
overall length 130 mm

- G-150001** size 0000/000
- G-150002** size 00/0
- G-150003** size 1/2
- G-150004** size 3/4
- G-150005** size 5/6



*BOWMAN*  
**LACRIMAL PROBE**  
cylindrical, stainless steel  
overall length 130 mm

- G-150101** size 0000/000
- G-150102** size 00/0
- G-150103** size 1/2
- G-150104** size 3/4
- G-150105** size 5/6



*BOWMAN*  
**LACRIMAL PROBE**  
bulbous tips, silver  
overall length 130 mm

- G-150051** size 0000/000
- G-150052** size 00/0
- G-150053** size 1/2
- G-150054** size 3/4
- G-150055** size 5/6



*BOWMAN*  
**LACRIMAL PROBE**  
bulbous tips, stainless steel  
overall length 130 mm

- G-150151** size 0000/000
- G-150152** size 00/0
- G-150153** size 1/2
- G-150154** size 3/4
- G-150155** size 5/6

JUENEMANN

**LACRIMAL PROBE**

with 72 mm probe and 18 mm grip plate  
to insert suture material  
provided with cleaning adaptor G-31022

- G-33193 0.6 mm diameter
- G-33194 0.8 mm diameter
- G-33195 1.0 mm diameter

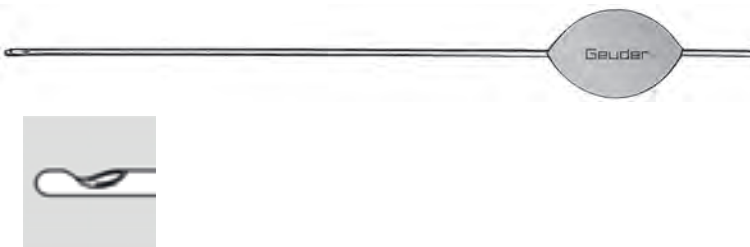

G-15315

KRUMEICH

**DALK PROBE**

for deep lamellar keratoplasty  
12 mm tapered probe  
overall length 73 mm



- G-15105 right
- G-15110 left

MACKENSEN

**TRABECULAR PROBE**

7 mm curved probe  
overall length 92 mm



- G-15125 right
- G-15130 left

HARMS

**TRABECULAR PROBE**

dual 9.5 mm curved probes  
3 mm spread  
overall length 46 mm



THOMAS NEUHANN

**U-SHAPED PROBE**

with holding plate  
dual 9 mm curved probes  
3 mm spread  
overall length 12 mm

- G-15136 0.30 mm probe diameter
- G-15138 0.25 mm probe diameter



G-15137

THOMAS NEUHANN

**HOLDER**

with lock  
for U-shaped probes G-15136 and G-15138  
overall length 92 mm



TRABECULAR PROBES · U-SHAPED PROBE · LACRIMAL PROBES

## CANNULAS I/A INSTRUMENTS



LACRIMAL .....	<b>189</b>
ANTERIOR CHAMBER MAINTAINERS .....	<b>191</b>
HYDRODISSECTION .....	<b>192</b>
IRRIGATION VECTIS .....	<b>193</b>
VISCOELASTIC .....	<b>194</b>
CAPSULE POLISHERS .....	<b>195</b>
LASIK .....	<b>196</b>
BIMANUAL IRRIGATION/ASPIRATION .....	<b>198</b>
COAXIAL IRRIGATION/ASPIRATION .....	<b>203</b>
BACKFLUSH .....	<b>206</b>
INFUSION .....	<b>209</b>



**LACRIMAL CANNULA**  
conical, straight  
tapers from 19 to 25 gauge  
25 mm shaft

**G-33140** silver  
**G-33135** stainless steel



**LACRIMAL CANNULA**  
conical, strongly curved  
tapers from 19 to 25 gauge  
25 mm shaft

**G-15140** silver  
**G-15141** stainless steel



**LACRIMAL CANNULA**  
conical, angled at 10 mm  
tapers from 19 to 25 gauge  
25 mm shaft

**G-15150** silver  
**G-15151** stainless steel





**LACRIMAL CANNULA**  
conical, angled at 18 mm  
tapers from 19 to 25 gauge  
25 mm shaft

**G-15160** silver  
**G-15161** stainless steel



**G-15190** *ANEL*  
**LACRIMAL CANNULA**  
straight  
15 mm shaft  
23 gauge / 0.64 mm





**G-15195** *ANEL*  
**LACRIMAL CANNULA**  
strongly curved  
16 mm shaft  
23 gauge / 0.64 mm





- LACRIMAL CANNULA**  
 cylindrical, straight
- G-33160** 20 gauge / 0.9 x 35 mm
  - G-33170** no. 12, 0.72 x 32 mm
  - G-33175** no. 14, 0.67 x 30 mm
  - G-33180** no. 16, 0.60 x 22 mm
  - G-33185** no. 18, 0.45 x 22 mm
  - G-33190** no. 20, 0.42 x 22 mm

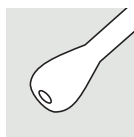

- G-15170** *BONN MODEL*  
**LACRIMAL CANNULA**  
 with probe tip  
 1.15 mm diameter olive tip

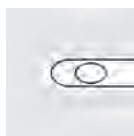

- BANGERTER*  
**LACRIMAL PROBE CANNULA**  
 straight, 0.6 mm side port
- G-15271** 23 gauge / 0.64 x 60 mm
  - G-15272** 21 gauge / 0.80 x 40 mm
  - G-15273** 23 gauge / 0.64 x 40 mm



- G-33197** *JUENEMANN*  
**LACRIMAL PROBE CANNULA**  
 to insert suture material  
 21 gauge / 0.8 x 35 mm



- G-33198** *JUENEMANN*  
**LACRIMAL PROBE CANNULA**  
 with grip plate  
 65 mm probe  
 to insert suture material  
 21 gauge / 0.8 x 65 mm



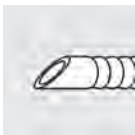

<p><b>G-15375</b> <b>G-32605</b> <b>G-32600</b> <b>G-15376</b> <b>G-15377</b></p>	<p><b>RETROBULBAR INJECTION CANNULA</b> 24 gauge / 0.6 x 60 mm 24 gauge / 0.6 x 35 mm 25 gauge / 0.5 x 35 mm 25 gauge / 0.5 x 50 mm 25 gauge / 0.5 x 40 mm</p>		
---	--	---	--

<p><b>G-15200</b></p>	<p><i>CRANZ</i> <b>EYE DOUCHE</b> irrigation through five front ports silver</p>		
-----------------------	--	---	---

<p><b>G-33416</b></p>	<p><i>BOPP</i> <b>ANTERIOR CHAMBER INFUSION CANNULA</b> anterior chamber maintainer with threaded tip for better fixation and silicone tube 20 gauge / 0.9 mm</p>		
-----------------------	---	---	---

<p><b>G-33422</b></p>	<p><i>BONN MODEL</i> <b>ANTERIOR CHAMBER INFUSION CANNULA</b> self-retaining textured tip dual 0.35 mm side ports silicone tube 15 cm 23 gauge / 0.6 mm</p>		
-----------------------	---	---	---

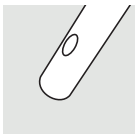
<p><b>G-16105</b></p>	<p><b>IRRIGATION CYSTOTOME CANNULA</b> 26 gauge / 0.45 mm</p>		
-----------------------	---	---	---

<p><b>G-15220</b></p>	<p><b>ENZYME CANNULA</b> 24 gauge / 0.6 mm</p>		
-----------------------	--	---	---

**G-15275 CYCLODIALYSIS SPATULA CANNULA**

12 mm long spatula  
anterior 0.2 mm port  
26 gauge / 0.45 mm



**G-31355 BUSSE CYCLODIALYSIS SPATULA CANNULA**

12 mm long spatula  
dual 0.2 mm port  
26 gauge / 0.45 mm



**G-15250 G-32166 G-32167 SAUTTER HYDRODISSECTION CANNULA**

front opening  
flattened tip  
vertical, 27 gauge / 0.4 mm  
vertical, 26 gauge / 0.45 mm  
horizontal, 27 gauge / 0.4 mm



vertical  
G-15250  
G-32166

horizontal  
G-32167



**G-32155 TUEBINGEN MODEL HYDRODISSECTION CANNULA**

30 gauge / 0.3 mm



**G-15185 FRANKFURT MODEL HYDRODISSECTION CANNULA**

27 gauge / 0.4 mm



**G-31895 HYDRODISSECTION CANNULA**

vertically flattened tip  
front opening  
24 gauge / 0.6 x 20 mm



**G-15252 G-15253 SPIRIG HYDRODISSECTION CANNULA**

for manual lens fragmentation  
right  
left



HYDRODISSECTION · CYCLODIALYSIS



**G-16115 IRRIGATION VECTIS CANNULA**

4 front ports  
5 mm wide lens loop  
curved

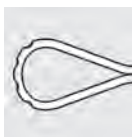

**G-32759 IRRIGATION VECTIS CANNULA**

small model  
4 front ports  
4 mm wide lens loop  
curved

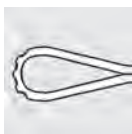

**G-31510 KLÖCKNER EXPRESSOR CANNULA**

8 mm wide lens loop  
4 front ports  
lightly curved



**G-31807 HEALON - VISCOELASTIC CANNULA**

flattened tip, angled at 6 mm  
30 mm shaft  
21 gauge / 0.8 mm



**G-22619 PH. JACOBI TRABECULAR ASPIRATION CANNULA**

angled at 13 mm  
24 gauge / 0.6 mm



**G-15188 G-15189 BURK IRRIGATION TRABECULOTOMY CANNULA**

8 mm curved irrigation probe  
30 gauge / 0.3 mm  
angled right  
angled left



**G-33199 NAGATA SUB-TENON INJECTION CANNULA**

for atraumatic penetration and  
injection of anesthetic agent  
24 gauge / 0.6 mm



**G-15180**      **IRRIGATION CANNULA**  
 bulbous tip, 0.75 mm diameter tip  
 extra delicate  
 26 gauge / 0.45 mm



**G-15230**      *BONN MODEL*  
**IRRIGATION CANNULA**  
 flattened tip, front opening  
 delicate, 0.5 x 1.5 mm  
**G-15240**      medium, 0.6 x 1.9 mm



**G-16134**      *BINKHORST*  
**IRRIGATION CANNULA**  
 U-shaped  
 22 gauge / 0.7 mm  
 straight  
**G-16135**      angled right  
**G-16136**      angled left



**G-32760**      *MUELLER*  
**IRRIGATION CANNULA**  
 J-shaped with probe tip  
 26 gauge / 0.45 x 19 mm  
 angled left  
**G-32765**      angled right



**G-16138**      *RENTSCH*  
**IRRIGATION CANNULA**  
 J-shaped  
 angled at 10 mm  
 26 gauge / 0.45 x 24 mm



**G-16106**      *SIMCOE*  
**IRRIGATION / ASPIRATION CANNULA**  
 dual shaft  
 0.3 mm diameter aspiration port  
 front opening irrigation port  
 23 gauge / 0.64 mm  
 with silicone tube and Luer-Lock hub

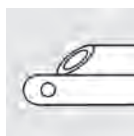

**G-16120**     **IRRIGATION / ASPIRATION CANNULA  
COAXIAL**

straight  
aspiration port 0.4 mm  
infusion tube 18 gauge / 1.2 mm

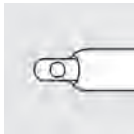

**G-15225**     **ASPIRATION CANNULA**

lightly curved, front opening  
delicate, 19 gauge / 1.1 mm  
**G-15226**  
standard, 17 gauge / 1.5 mm



**G-16125**     **KRATZ  
CAPSULE POLISHING CANNULA**

angled at 2 mm  
half-textured tip  
23 gauge / 0.64 mm



**G-16133**     **TEPING  
ASPIRATION POLISHING CANNULA**

0.3 mm posterior port  
half-textured tip, curved  
23 gauge / 0.64 mm



**G-16130**     **CAPSULE POLISHING CANNULA**

with half-textured ball tip  
18 gauge / 1.2 mm



**G-16132**     **PAPST  
CAPSULE POLISHING CANNULA**

0.75 mm hemisphere textured tip  
25 gauge / 0.5 mm



**G-32529**     **KYU  
CAPSULE POLISHING CANNULA**

2 mm disc-shaped tip  
textured  
**G-32527**  
22 gauge / 0.7 mm  
23 gauge / 0.64 mm



G-32528

*GREITE*  
**CAPSULE POLISHING CANNULA**  
 curette tip  
 textured  
 22 gauge / 0.7 mm



G-32774

*BRAUWEILER*  
**ASPIRATION CANNULA**  
 angled at 13 mm  
 textured polisher tip  
 0.3 mm beveled port  
 21 gauge / 0.8 mm



G-32769

*H.-R. KOCH*  
**ASPIRATION CANNULA**  
 angled at 14 mm  
 0.3 mm anterior port  
 half-textured, spatulated tip  
 21 gauge / 0.8 mm



G-32776

*BRAUWEILER*  
**IRRIGATION CANNULA**  
 angled at 12 mm  
 front opening  
 21 gauge / 0.8 mm



G-32772

*BRAUWEILER*  
**IRRIGATION CANNULA**  
 angled at 13 mm  
 textured 0.8 mm iris retractor and  
 capsule polisher  
 21 gauge / 0.8 mm



G-33909

*W. BAUER*  
**LASIK CANNULA**  
 double-armed  
 6 ports  
 for irrigation of the flap and stromal bed  
 25 gauge / 0.5 mm



CAPSULER POLISHERS · LASIK

15

**G-33910**     *ZIRM*  
**LASIK DISSECTOR CANNULA**  
flattened  
front opening  
25 gauge / 0.5 mm



**G-33911**     *ZIRM*  
**LASIK IRRIGATION CANNULA**  
flattened and textured tip  
with 5 irrigation ports  
20 gauge / 0.9 mm



**G-15310**     *KRUMEICH*  
**CORNEAL IRRIGATION CANNULA**  
for big bubble technique during DALK  
semi-sharp dissector tip  
0.2 mm posterior port  
27 gauge / 0.4 mm



*KRUMEICH*  
**CORNEAL IRRIGATION CANNULA**  
for big bubble technique during DALK  
angled at 12 mm  
23 gauge / 0.6 mm  
**G-15312**     0.4 mm anterior port  
**G-15314**     0.4 mm posterior port



**G-22550**     **IRRIGATION CANNULA HANDPIECE**  
overall length 115 mm



**G-32015**     **IRRIGATION CANNULA HANDPIECE**  
male / female connectors  
overall length 112 mm

**G-32771** *BRAUWEILER*  
**IRRIGATION CANNULA HANDPIECE**  
 male / female connectors  
 78 mm



**G-32773** *BRAUWEILER*  
**ASPIRATION CANNULA HANDPIECE**  
 male / male connectors  
 80 mm



**G-32778** *KEERL*  
**IRRIGATION CANNULA HANDPIECE**  
 with silicone tube



**G-32010** **IRRIGATION CANNULA HANDPIECE**  
 with silicone tube



*SCHMACK*  
 21 gauge / 0.8 mm



**G-22632** **IRRIGATION HANDPIECE**  
 0.5 mm port

**G-22633** **ASPIRATION HANDPIECE**  
 0.3 mm port



*D.D. KOCH - T. KOHNEN*  
**ASPIRATION HANDPIECE**  
 0.3 mm aspiration port  
 textured tip



**G-22100** 22 gauge / 0.7 mm  
**G-22102** 23 gauge / 0.6 mm

**G-22101**

*D.D. KOCH - T. KOHNEN*  
**IRRIGATION HANDPIECE**  
front opening  
22 gauge / 0.7 mm



**G-22105**  
**G-22106**

**ASPIRATION HANDPIECE**  
0.25 mm aspiration port  
conical tip  
oval tube 0.95 x 0.55 mm  
smooth  
textured



**G-22107**

**IRRIGATION HANDPIECE**  
0.5 mm irrigation port  
conical tip  
oval tube 0.95 x 0.55 mm

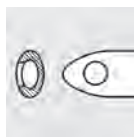

**G-22637**

*SCHMACK*  
**ASPIRATION HANDPIECE**  
4 x 0.15 mm posterior ports  
textured tip  
23 gauge / 0.6 mm



**G-32011 ASPIRATION HANDPIECE**

0.3 mm aspiration port  
textured, conical tip  
21 gauge / 0.8 mm



**G-32012 IRRIGATION HANDPIECE**

dual 0.5 mm irrigation ports  
textured, conical tip  
21 gauge / 0.8 mm



**G-32018 BRAUWEILER ASPIRATION HANDPIECE**

angled at 13 mm  
0.3 mm beveled port  
textured tip  
21 gauge / 0.8 mm



**G-32019 H.-R. KOCH ASPIRATION HANDPIECE**

angled at 14 mm  
0.3 mm anterior port  
half-textured, spatulated tip  
21 gauge / 0.8 mm





**G-32016** *BRAUWEILER*  
**IRRIGATION HANDPIECE**  
angled at 12 mm  
front opening  
21 gauge / 0.8 mm



**G-32017** *BRAUWEILER*  
**IRRIGATION HANDPIECE**  
angled at 13 mm  
textured 0.8 mm iris retractor and  
capsule polisher  
21 gauge / 0.8 mm



**G-32026** *R. KOCH*  
**ASPIRATION HANDPIECE**  
0.3 mm aspiration port  
textured tip  
19 gauge / 1.1 mm



**G-32028** *R. KOCH*  
**IRRIGATION HANDPIECE**  
angled  
dual 0.75 mm side ports  
19 gauge / 1.1 mm



**G-32014**

*R. KOCH*

**IRRIGATION CHOPPER**

angled  
dual 0.75 mm side ports  
1 mm angled chopper tip  
19 gauge / 1.1 mm



**G-32059**

*DICK*

**IRRIGATION CHOPPER**

angled  
dual 0.75 mm side ports  
1 mm curved chopper tip  
19 gauge / 1.1 mm



**G-38601**

*ALTHAUS / CARTSBURG*

**IRRIGATION DESCMET HOOK**

hook diameter: 0.25 mm  
hook length: 0.6 mm  
for Descemetorhexis  
rhombic 0.9 x 0.6 mm irrigation tube  
overall length 98 mm



**G-38602**

*THOMAS NEUHANN*

**IRRIGATION DESCMET SCRAPER**

scraper width: 0.8 mm  
scraper length: 0.6 mm  
rhombic 0.9 x 0.6 mm irrigation tube  
for peripheral scraping of the recipient bed  
overall length 94 mm



**G-38631** *SZURMAN*  
**DMEK IRRIGATION HANDPIECE**  
curved, closed tip  
side port 0.3 mm  
tube 23 gauge / 0.6 mm



**G-38632** *SZURMAN*  
**DMEK IRRIGATION HANDPIECE**  
curved, front opening  
tube 23 gauge / 0.6 mm



**PEP 2.2 MM I/A HANDPIECE**  
Pure Efficiency Phaco  
for 2.2 mm incisions  
0.3 mm aspiration port

**G-24318** coaxial I/A straight tip  
**G-24418** coaxial I/A 30° angled tip

with G-24311 PEP infusion sleeve



**G-24311** **PEP 2.2 MM INFUSION SLEEVE**  
Pure Efficiency Phaco  
for 2.2 mm incisions  
purple translucent silicone





**PEP 2.4 MM I/A HANDPIECE**

Pure Efficiency Phaco  
for 2.4 mm incisions  
0.3 mm aspiration port  
coaxial I/A straight tip  
coaxial I/A 30° angled tip

**G-24332**  
**G-24432**

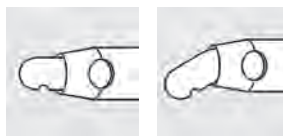

with G-24314 PEP infusion sleeve

**G-24314**

**PEP 2.4 MM INFUSION SLEEVE**

Pure Efficiency Phaco  
for 2.4 mm incisions  
green translucent silicone

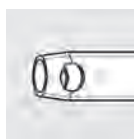

**G-24330**

**I/A HANDPIECE**

coaxial straight tip  
0.3 mm aspiration port  
with G-24100 infusion sleeve

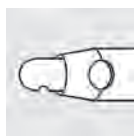

**I/A HANDPIECE**

coaxial 30° angled tip  
0.3 mm aspiration port  
0.35 mm aspiration port  
0.4 mm aspiration port

**G-24430**  
**G-24435**  
**G-24440**



with G-24100 infusion sleeve

COAXIAL IRRIGATION/ASPIRATION

15

**G-24100**     **INFUSION SLEEVE**  
blue silicone  
for I/A handpieces



*PAPST*  
**I/A HANDPIECE**

coaxial  
infusion tube 16 gauge / 1.6 mm  
aspiration port 0.3 mm, straight  
**G-22525**  
**G-22527** aspiration port 0.4 mm, straight  
**G-22540** aspiration port 0.3 mm, angled 30°  
**G-22542** aspiration port 0.4 mm, angled 30°  
**G-22545** aspiration port 0.5 mm, angled 30°



**G-22615**     *PAPST*  
**I/A HANDPIECE**  
coaxial 30° angled tip  
aspiration port 0.3 mm  
infusion tube 18 gauge / 1.3 mm

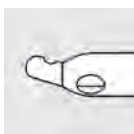

**G-22556**     *HUNOLD*  
**I/A HANDPIECE**  
coaxial, curved  
aspiration port 0.3 mm  
infusion tube 18 gauge / 1.3 mm



**G-33045 BACKFLUSH HANDPIECE**

with Luer cone  
overall length 110 mm



**G-31805 BACKFLUSH HANDPIECE**

with silicone chamber and Luer cone  
overall length 110 mm



**G-37002 BACKFLUSH HANDPIECE**

with silicone chamber and Luer-Lock connector  
overall length 115 mm



**G-37000 BACKFLUSH HANDPIECE**

with silicone chamber and chuck  
overall length 110 mm



for backflush tips G-37010 up to G-37080

**SILICONE CHAMBER**

for backflush handpieces  
G-31805, G-37000, G-37002



**G-31806**

reusable

**G-34806**

single use, 10 pcs. per box, sterile



**G-37005 BACKFLUSH HANDPIECE**

with large silicone chamber  
rotatable chuck

for backflush cannulas G-37010 up to G-37080

**G-37006**

**SILICONE CHAMBER**

large, for backflush handpiece G-37005







RETINAL · BACKFLUSH HANDPIECES

<b>G-33050</b> <b>G-33054</b> <b>G-33053</b>	<b>BACKFLUSH CANNULA</b>		
	35 mm shaft		
	20 gauge / 0.9 mm		
	23 gauge / 0.6 mm		
	25 gauge / 0.5 mm		

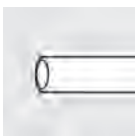
<b>G-33070</b>	<b>BACKFLUSH CANNULA</b>		
	35 mm shaft		
	20 gauge / 0.9 mm shaft		
	25 gauge / 0.5 mm tip		
	3.5 mm tapered tip		

<b>G-33071</b>	<b>BACKFLUSH CANNULA</b>		
	35 mm shaft		
	0.5 mm side port		
	20 gauge / 0.9 mm		

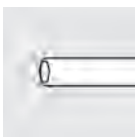
<b>G-33072</b>	<i>LAQUA</i>		
	<b>BACKFLUSH CANNULA</b>		
	35 mm shaft		
	inside diameter: 21 gauge / 0.8 mm		
	outside diameter: 19 gauge / 1.1 mm		

<b>G-33073</b>	<i>KAMPIK</i>		
	<b>BACKFLUSH CANNULA</b>		
	35 mm shaft		
	inside diameter: 22 gauge / 0.7 mm		
	outside diameter: 20 gauge / 0.9 mm		

<b>G-33075</b>	<b>BACKFLUSH CANNULA</b>		
	35 mm shaft		
	0.8 mm silicone brush		
	20 gauge / 0.9 mm		

<b>G-33077</b>	<b>BACKFLUSH CANNULA</b>		
	20 gauge / 0.9 mm shaft		
	24 gauge / 0.55 mm tip		
	7 mm tapered tip, angled at 3.5 mm		

**G-37010** **BACKFLUSH TIP**  
 35 mm shaft  
 20 gauge / 0.9 mm

**G-37011**  
 23 gauge / 0.6 mm

**G-37012**  
 25 gauge / 0.5 mm



**G-37015** **BACKFLUSH TIP**  
 35 mm shaft  
 angled at 3 mm  
 20 gauge / 0.9 mm



**G-37020** **BACKFLUSH TIP**  
 35 mm shaft  
 0.8 mm silicone brush  
 20 gauge / 0.9 mm



**G-37025** **BACKFLUSH TIP**  
 35 mm shaft  
 angled at 6 mm  
 0.8 mm silicone brush  
 20 gauge / 0.9 mm



**G-37035** **BACKFLUSH TIP**  
 35 mm shaft  
 0.8 mm silicone tip  
 20 gauge / 0.9 mm



**G-37046** *KLEIN* **BACKFLUSH TIP**  
 20 gauge / 0.9 mm shaft  
 26 gauge / 0.45 mm tip  
 2 mm tapered tip  
 overall length 35 mm



**G-37065** **BACKFLUSH TIP**  
 35 mm shaft  
 20 gauge / 0.9 mm shaft  
 30 gauge / 0.3 mm tip  
 tapered tip, angled at 5 mm  
 oval aspiration port



RETINAL · BACKFLUSH TIPS

15



**G-37080**

**BACKFLUSH TIP**

35 mm shaft  
20 gauge / 0.9 mm shaft  
23 gauge / 0.6 mm tip  
2 mm tapered tip  
overall length 35 mm



**G-33420**

**INFUSION CANNULA**

silicone tube 40 cm  
Luer-Lock metal adapter  
20 gauge / 0.9 mm  
beveled, 4.0 mm (single-use G-33463)  
**G-33425** beveled, 5.0 mm  
**G-33430** beveled, 6.0 mm



**G-33450**

**INFUSION CANNULA**

silicone tube 40 cm  
Luer-Lock plastic adapter  
20 gauge / 0.9 mm  
beveled, 4.0 mm  
**G-33451** beveled, 5.0 mm  
**G-33452** beveled, 6.0 mm



**G-33484**

**INJECTION CANNULA**

for viscous fluids, without silicone tube  
for butterfly-19 cannula  
20 gauge / 0.9 mm  
beveled, 4.0 mm  
**G-33485** beveled, 5.0 mm  
**G-33486** beveled, 6.0 mm



**G-33494**

**INJECTION CANNULA**

for viscous fluids, without silicone tube  
for butterfly-21 cannula  
20 gauge / 0.9 mm  
beveled, 4.0 mm  
**G-33495** beveled, 5.0 mm  
**G-33496** beveled, 6.0 mm



**G-32180**

*DUISBURG MODEL*  
**INJECTION CANNULA**

for viscous fluids  
25 cm silicone tube with 2 metal sleeves  
and Luer-Lock adapter  
20 gauge / 0.9 mm  
beveled, 4.0 mm  
**G-32181** beveled, 5.0 mm  
**G-32182** beveled, 6.0 mm

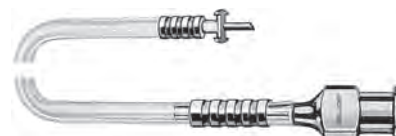

*HAMBURG MODEL*

**INJECTION CANNULA**

for viscous fluids  
25 cm silicone tube with metal sleeve  
and Luer-Lock adapter  
3 spare silicone tubes

- G-33470** 20 gauge / 0.9 mm, beveled, 4 mm
- G-33471** 20 gauge / 0.9 mm, beveled, 5 mm
- G-33472** 20 gauge / 0.9 mm, beveled, 6 mm
- G-33473** 23 gauge / 0.6 mm, beveled, 4 mm
- G-33474** 23 gauge / 0.6 mm, beveled, 6 mm



**G-33475 SPARE SILICONE TUBE**

for injection cannulas  
25 cm  
3 pcs. per box



*WEBER*

**ASPIRATION CANNULA**

for viscous fluids  
inside diameter: 22 gauge / 0.7 mm  
outside diameter: 20 gauge / 0.9 mm

- G-33051** 5 mm shaft
- G-33052** 10 mm shaft

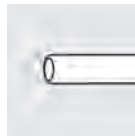

**G-37390 ASPIRATION CANNULA**

23 gauge / 0.6 mm  
10 mm shaft



**G-33056 ROIDER ASPIRATION CANNULA**

for viscous fluids  
0.7 mm side port  
19 gauge / 1.0 mm



**G-33055 PFCL CANNULA**

with dual shaft  
24 gauge / 0.55 mm  
25 gauge / 0.5 mm, lateral tube

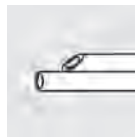

**G-33057 CHANG PFCL CANNULA**

for injection of heavy fluids  
dual bore, coaxial  
25 gauge / 0.5 mm tip  
20 gauge / 0.9 mm shaft



*HEIDELBERG MODEL*

**CANNULA**

for injection or aspiration of viscous fluids  
and Densiron<sup>®</sup> 68, bevel 30°

**G-32699**

19 gauge / 1.1 mm

**G-32698**

18 gauge / 1.2 mm

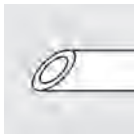

**STOPPER**

for viscous fluid aspiration  
with tube connection for single-use syringe

**G-33065**

10 ml syringe

**G-33066**

20 ml syringe



**PRESSURE TUBE**

for injection of viscous fluids  
Luer-Lock female / male  
reusable

**G-32697**

single use, 10 pcs. per box, sterile

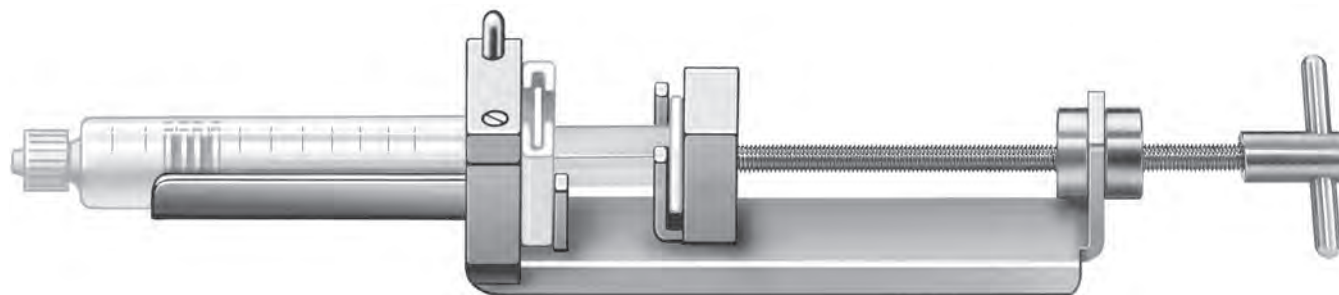

**G-28752**

**SYRINGE HOLDER**

for manual injection of  
viscous fluids in glass syringes,  
with clamp and retraction mechanism

**SYRINGE CLIP**

customized labeling  
for 2 ml syringes  
for 5 ml syringes

**G-19960**

**G-19961**



**SILICONE BULB**

with Luer Cone  
20 ml  
60 ml

**G-32665**

**G-32670**



## SINGLE USE INSTRUMENTS



NANOEDGE TREPHINES AND PUNCHES .....	<b>215</b>
NANOEDGE SURGICAL KNIVES .....	<b>217</b>
UNO COLORLINE (SCISSORS · FORCEPS · PROBES · TROCARS · FIBER OPTICS · VITREOUS CUTTERS) .....	<b>218</b>
SPECULUM .....	<b>223</b>
DMEK CARTRIDGE .....	<b>223</b>
IRIS RETRACTOR .....	<b>223</b>
LACRIMAL INTUBATION .....	<b>223</b>
CANNULAS .....	<b>224</b>
BIMANUAL HANDPIECE SET .....	<b>227</b>
BACKFLUSH .....	<b>227</b>
INFUSION / INJECTION CANNULAS .....	<b>228</b>
SCLERAL BUCKLING COMPONENTS .....	<b>232</b>



## NANOEDGE TREPHINES

length 16 mm  
sterile, single-use

<b>G-520400</b>	4.00 mm	<b>G-520825</b>	8.25 mm	<b>G-521350</b>	13.50 mm
<b>G-520500</b>	5.00 mm	<b>G-520850</b>	8.50 mm	<b>G-521400</b>	14.00 mm
<b>G-520550</b>	5.50 mm	<b>G-520875</b>	8.75 mm	<b>G-521450</b>	14.50 mm
<b>G-520600</b>	6.00 mm	<b>G-520900</b>	9.00 mm	<b>G-521500</b>	15.00 mm
<b>G-520625</b>	6.25 mm	<b>G-520950</b>	9.50 mm	<b>G-521550</b>	15.50 mm
<b>G-520650</b>	6.50 mm	<b>G-521000</b>	10.00 mm	<b>G-521600</b>	16.00 mm
<b>G-520675</b>	6.75 mm	<b>G-521050</b>	10.50 mm	<b>G-521650</b>	16.50 mm
<b>G-520700</b>	7.00 mm	<b>G-521100</b>	11.00 mm	<b>G-521700</b>	17.00 mm
<b>G-520725</b>	7.25 mm	<b>G-521150</b>	11.50 mm	<b>G-521800</b>	18.00 mm
<b>G-520750</b>	7.50 mm	<b>G-521200</b>	12.00 mm		
<b>G-520775</b>	7.75 mm	<b>G-521250</b>	12.50 mm		
<b>G-520800</b>	8.00 mm	<b>G-521300</b>	13.00 mm		



**G-500001**    **NANOEDGE SINGLE-USE CORNEAL CUTTING BLOCK**  
Teflon, sterile



## NANOEDGE TREPHINE PUNCHES

sterile, single-use

<b>G-540600</b>	6.00 mm	<b>G-540725</b>	7.25 mm	<b>G-540850</b>	8.50 mm
<b>G-540625</b>	6.25 mm	<b>G-540750</b>	7.50 mm	<b>G-540875</b>	8.75 mm
<b>G-540650</b>	6.50 mm	<b>G-540775</b>	7.75 mm	<b>G-540900</b>	9.00 mm
<b>G-540675</b>	6.75 mm	<b>G-540800</b>	8.00 mm	<b>G-540925</b>	9.25 mm
<b>G-540700</b>	7.00 mm	<b>G-540825</b>	8.25 mm	<b>G-540950</b>	9.50 mm



## NANOEDGE VACUUM TREPHINE PUNCHES

sterile, single-use

<b>G-560600</b>	6.00 mm	<b>G-560725</b>	7.25 mm	<b>G-560850</b>	8.50 mm
<b>G-560625</b>	6.25 mm	<b>G-560750</b>	7.50 mm	<b>G-560875</b>	8.75 mm
<b>G-560650</b>	6.50 mm	<b>G-560775</b>	7.75 mm	<b>G-560900</b>	9.00 mm
<b>G-560675</b>	6.75 mm	<b>G-560800</b>	8.00 mm	<b>G-560925</b>	9.25 mm
<b>G-560700</b>	7.00 mm	<b>G-560825</b>	8.25 mm	<b>G-560950</b>	9.50 mm

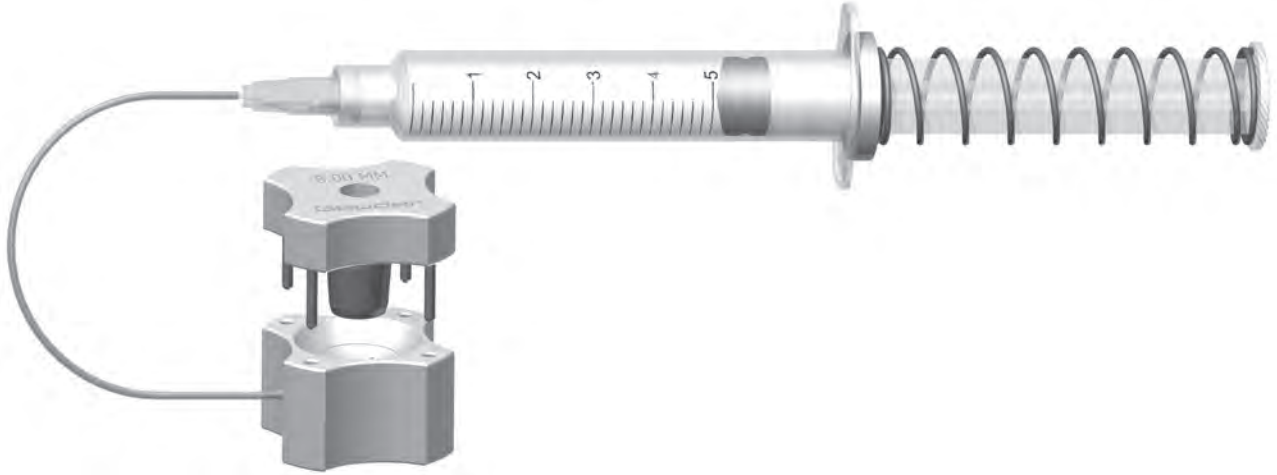

## NANOEDGE VACUUM TREPHINE radial

sterile, single-use

<b>G-570600</b>	6.00 mm	<b>G-570750</b>	7.50 mm	<b>G-570850</b>	8.50 mm
<b>G-570650</b>	6.50 mm	<b>G-570775</b>	7.75 mm	<b>G-570875</b>	8.75 mm
<b>G-570700</b>	7.00 mm	<b>G-570800</b>	8.00 mm	<b>G-570900</b>	9.00 mm
<b>G-570725</b>	7.25 mm	<b>G-570825</b>	8.25 mm		

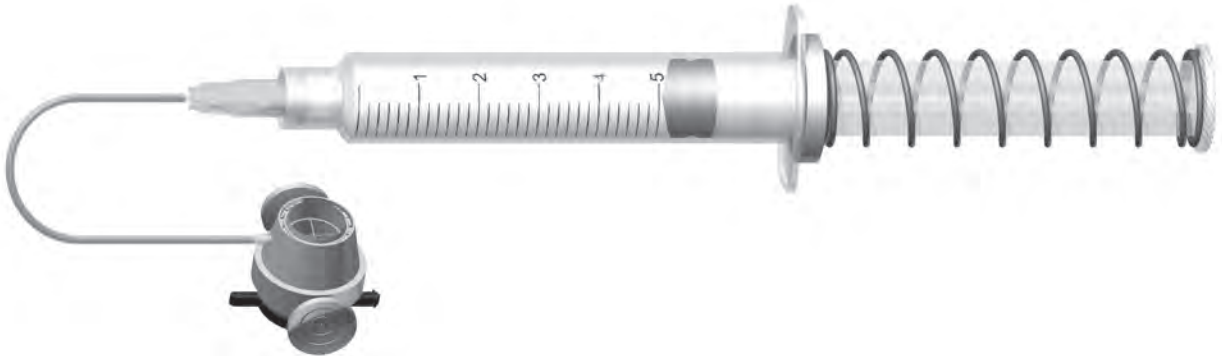



## SINGLE-USE KNIVES FOR OPHTHALMIC SURGERY

6 pcs. per box  
sterile



### NANOEDGE PARACENTESIS KNIVES



**G-34026** 15°  
**G-34064** 15° protect  
with sliding guard



**G-34031** 22,5°



**G-34036** 30°



**NANOEDGE MVR STILETT** straight  
diameter insertable instruments

**G-34181** 20 gauge / 0.9 mm  
**G-34192** 23 gauge / 0.6 mm  
**G-34198** 25 gauge / 0.5 mm

incision / blade width

1.2 mm  
0.8 mm  
0.7 mm

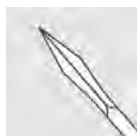

**NANOEDGE MVR STILETT** angled  
diameter insertable instruments

**G-34191** 20 gauge / 0.9 mm  
**G-34196** 23 gauge / 0.6 mm  
**G-34197** 25 gauge / 0.5 mm

incision / blade width

1.2 mm  
0.8 mm  
0.7 mm



**NANOEDGE PHACO SLIT KNIFE**  
angled, double bevel

**G-34050** 1.80 mm  
**G-34051** 2.20 mm  
**G-34052** 2.40 mm  
**G-34053** 2.50 mm  
**G-34054** 2.75 mm  
**G-34055** 2.85 mm  
**G-34060** 2.20 mm, protect, with sliding guard  
**G-34061** 2.40 mm, protect, with sliding guard  
**G-34062** 2.85 mm, protect, with sliding guard



**CLEAR CORNEA KNIFE**  
angled, double bevel

**G-34122** 2.75 mm  
**G-34126** 3.00 mm

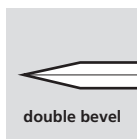

**NANOEDGE CRESCENT KNIFE**  
angled, bevel up

**G-34081** 2.0 mm

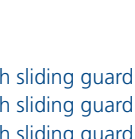

**NANOEDGE SPOON KNIFE**  
angled, double bevel

**G-34086** 2.2 mm



**NANOEDGE IMPLANT KNIFE**  
angled, bevel up

**G-34146** 6.0 mm

**20G** RED: 20 GAUGE / 0.9 MM

**23G** GREEN: 23 GAUGE / 0.6 MM

**25G** BLUE: 25 GAUGE / 0.5 MM

## SCISSORS

### SINGLE-USE VITREOUS SCISSORS UNO COLORLINE

straight, sterile



**G-42061** 20G, 1 pcs. per box

**G-42361** 23G, 1 pcs. per box

**G-42561** 25G, 1 pcs. per box

### SINGLE-USE VITREOUS SCISSORS UNO COLORLINE

curved, sterile



**G-42362** 23G, 1 pcs. per box

**G-46362** 23G, 6 pcs. per box

**G-42562** 25G, 1 pcs. per box

**G-46562** 25G, 6 pcs. per box

## HANDLES

### HANDLE UNO COLORLINE 20G, 23G, 25G

titanium handle for UNO Colorline  
single-use tips

**G-40006** 6 mm diameter

**G-40008** 8 mm diameter



## FORCEPS

### SINGLE-USE VITREOUS FORCEPS ENDGRIPPING UNO COLORLINE

straight, extra delicate,  
endgripping 0.3 mm x 0.1 mm, sterile



**G-42041** 20G, 1 pcs. per box  
**G-46041** 20G, 6 pcs. per box

**G-42341** 23G, 1 pcs. per box  
**G-46341** 23G, 6 pcs. per box

**G-42541** 25G, 1 pcs. per box  
**G-46541** 25G, 6 pcs. per box

### HATTENBACH

### SINGLE-USE VITREOUS FORCEPS WAVE DESIGN UNO COLORLINE

straight, wave design, 0.3 mm x 0.5 mm,  
sterile



**G-42042** 20G, 1 pcs. per box  
**G-46042** 20G, 6 pcs. per box

**G-42342** 23G, 1 pcs. per box  
**G-46342** 23G, 6 pcs. per box

**G-42542** 25G, 1 pcs. per box  
**G-46542** 25G, 6 pcs. per box

### SINGLE-USE VITREOUS FORCEPS CROCODILE DESIGN UNO COLORLINE

straight, crocodile design 0.3 mm x 2.5 mm,  
sterile



**G-42043** 20G, 1 pcs. per box

**G-42343** 23G, 1 pcs. per box  
**G-46343** 23G, 6 pcs. per box

### SINGLE-USE TANO FORCEPS UNO COLORLINE

straight, sterile



**G-42044** 20G, 1 pcs. per box

**G-42344** 23G, 1 pcs. per box

**G-42544** 25G, 1 pcs. per box

**20G RED: 20 GAUGE / 0.9 MM**

**23G GREEN: 23 GAUGE / 0.6 MM**

**25G BLUE: 25 GAUGE / 0.5 MM**

ENDO PROBES

**SINGLE-USE ENDO-PROBE S  
UNO COLORLINE**

straight, plug for GEUDER endoTRON, sterile



**G-61201** 20G, 5 pcs. per box

**G-61231** 23G, 5 pcs. per box

**G-61251** 25G, 5 pcs. per box

**SINGLE-USE ENDO-PROBE S  
UNO COLORLINE**

straight, plug for IRIDEX® Laser, sterile



**G-61204** 20G, 5 pcs. per box

**G-61234** 23G, 5 pcs. per box

**G-61254** 25G, 5 pcs. per box

**SINGLE-USE ENDO-PROBE C  
UNO COLORLINE**

curved, plug for GEUDER endoTRON, sterile



**G-61202** 20G, 5 pcs. per box

**G-61232** 23G, 5 pcs. per box

**G-61252** 25G, 5 pcs. per box

**SINGLE-USE ENDO-PROBE C  
UNO COLORLINE**

curved, plug for IRIDEX® Laser, sterile



**G-61205** 20G, 5 pcs. per box

**G-61235** 23G, 5 pcs. per box

**G-61255** 25G, 5 pcs. per box

**20G RED: 20 GAUGE / 0.9 MM**

**23G GREEN: 23 GAUGE / 0.6 MM**

**25G BLUE: 25 GAUGE / 0.5 MM**

## TROCAR SYSTEMS

*HATTENBACH / NIKOLIC*

### SINGLE-USE TROCAR SYSTEM ONE-STEP UNO COLORLINE

3 ports for one-step technique,  
incl. infusion tubing, sterile

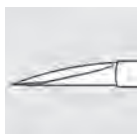

**G-42011** 20G, 1 set per box  
**G-46011** 20G, 6 sets per box

**G-42311** 23G, 1 set per box  
**G-46311** 23G, 6 sets per box

**G-42511** 25G, 1 set per box  
**G-46511** 25G, 6 sets per box

### SINGLE-USE TROCAR PLUGS UNO COLORLINE

**G-42019** 20G, 1 set (3 pcs.) per box

**G-42319** 23G, 1 set (3 pcs.) per box



## FIBER OPTICS

### SINGLE-USE FIBER OPTIC S UNO COLORLINE

spot, sterile



**G-42021** 20G, 1 pcs. per box  
**G-46021** 20G, 6 pcs. per box

**G-42321** 23G, 1 pcs. per box  
**G-46321** 23G, 6 pcs. per box

**G-42521** 25G, 1 pcs. per box  
**G-46521** 25G, 6 pcs. per box

### SINGLE-USE FIBER OPTIC W UNO COLORLINE

wide angle, sterile

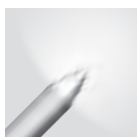

**G-42022** 20G, 1 pcs. per box  
**G-46022** 20G, 6 pcs. per box

**G-42322** 23G, 1 pcs. per box  
**G-46322** 23G, 6 pcs. per box

**G-42522** 25G, 1 pcs. per box  
**G-46522** 25G, 6 pcs. per box

**20G RED: 20 GAUGE / 0.9 MM**

**23G GREEN: 23 GAUGE / 0.6 MM**

**25G BLUE: 25 GAUGE / 0.5 MM**

**SINGLE-USE FIBER OPTIC WS  
UNO COLORLINE**  
wide angle, shielded, sterile



**G-42023** 20G, 1 pcs. per box  
**G-46023** 20G, 6 pcs. per box

**G-42323** 23G, 1 pcs. per box  
**G-46323** 23G, 6 pcs. per box

**G-42523** 25G, 1 pcs. per box  
**G-46523** 25G, 6 pcs. per box

## VITREOUS CUTTERS

**SINGLE-USE HIGH SPEED VITREOUS CUTTER  
UNO COLORLINE**  
pneumatic, with GEUDER safety-connector,  
sterile



**G-42001** 20G, 1 pcs. per box  
**G-46001** 20G, 6 pcs. per box

**G-42301** 23G, 1 pcs. per box  
**G-46301** 23G, 6 pcs. per box

**G-42501** 25G, 1 pcs. per box  
**G-46501** 25G, 6 pcs. per box

**SINGLE-USE HIGH SPEED VITREOUS CUTTER  
MACH 2 UNO COLORLINE**  
Doubleblade, pneumatic,  
with GEUDER safety-connector, sterile



**G-42002** 20G, 1 pcs. per box  
**G-46002** 20G, 6 pcs. per box

**G-42302** 23G, 1 pcs. per box  
**G-46302** 23G, 6 pcs. per box

**G-42502** 25G, 1 pcs. per box  
**G-46502** 25G, 6 pcs. per box

**SINGLE-USE INFUSION TUBE 20G  
UNO COLORLINE**  
for 20 gauge GEUDER  
UNO Colorline vitreous cutters, sterile  
**G-42009** 20G, 1 pcs. per box



FIBRE OPTICS · VITREOUS CUTTERS · INFUSION TUBE



- G-34340**     **SINGLE-USE EYE SPECULUM**  
with aspiration, 2 x 4 aspiration ports  
fenestrated, open blades  
5 pcs. per box, sterile



*SZURMAN*

- SINGLE-USE DMEK-CARTRIDGE**  
for Descemet Membrane Endothelial Keratoplasty  
incl. Tube connection for loading  
the cartridge, sterile

- G-38630**     incision 3 mm, 14 gauge / 2.0 mm  
**G-38635**     incision 2.4 to 2.75 mm, 16 gauge / 1.6 mm

- G-34523**     **SINGLE-USE IRIS RETRACTOR**  
for mechanical dilation of the pupil, flexible  
4 iris retractors per set, 2 sets per box, sterile



- G-34810**     **LACRIMAL INTUBATION TUBING**  
silicone tubing 35 cm  
OD 0.6 mm, ID 0.3 mm  
10 pcs. per box, sterile



- G-34811**     **LACRIMAL INTUBATION SET**  
suture with silicone tubing  
0.6 mm  
10 pcs. per box, sterile



**G-34812 LACRIMAL INTUBATION SET**  
 silicone tubing 0.6 mm  
 2 probes 110 mm with olive tips  
 27 gauge / 0.4 mm  
 3 pcs. per box, sterile



**G-34814 DCR LACRIMAL INTUBATION SET**  
 silicone tubing 0.6 mm, 2 probes 45 mm  
 20 gauge / 0.9 mm  
 3 pcs. per box, sterile



**G-34290 SINGLE-USE LACRIMAL CANNULA**  
 curved 26 gauge / 0.45 x 30 mm  
 10 pcs. per box, sterile



**G-34200 SINGLE-USE RETROBULBAR CANNULA**  
 10 pcs. per box, sterile  
 25 gauge, 0.5 x 40 mm  
**G-34205**  
 26 gauge, 0.45 x 50 mm



*ATKINSON*  
**G-34210 SINGLE-USE RETROBULBAR CANNULA**  
 10 per box, sterile  
 25 gauge, 0.5 x 40 mm  
**G-34215**  
 23 gauge, 0.64 x 40 mm



**G-34220 SINGLE-USE PERIBULBAR CANNULA**  
 25 gauge, 0.5 x 30 mm  
 10 pcs. per box, sterile



**G-34225 SINGLE-USE CYSTOTOME CANNULA**  
 vaulted, 45°  
 25 gauge / 0.5 mm  
 10 pcs. per box, sterile  
**G-34230**  
 12.5 mm long, side cutting  
 12.5 mm long





**G-34261** *LEWICKY*  
**SINGLE-USE A. C. MAINTAINER**  
20 gauge / 0.9 mm, tip 5 mm  
3 pcs. per box, sterile

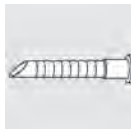

**G-34235** *RYCROFT*  
**SINGLE-USE A. C. CANNULA**  
angled at 5 mm, 45°  
10 pcs. per box, sterile  
**G-34240** 20 gauge, 0.9 x 5 + 17 mm  
25 gauge, 0.5 x 25 mm



**G-34245** *SAUTTER*  
**SINGLE-USE HYDRODISSECTION CANNULA**  
vertically flattened  
27 gauge / 0.4 x 22 mm  
10 pcs. per box, sterile



**G-34270** *TUEBINGEN MODEL*  
**SINGLE-USE HYDRODISSECTION CANNULA**  
30 gauge / 0.3 x 22 mm  
10 pcs. per box, sterile



**G-34271** *FRANKFURT MODEL*  
**SINGLE-USE HYDRODISSECTION CANNULA**  
27 gauge / 0.4 mm  
10 pcs. per box, sterile



CANNULAS (A.C. MAINTAINER, RYCROFT, HYDRODISSECTION)

**G-34265** **SINGLE-USE IRRIGATION VECTIS CANNULA**  
 double port  
 25 gauge / 0.5 mm  
 10 pcs. per box, sterile



**G-34255** *KRATZ*  
**SINGLE-USE CAPSULE POLISHING CANNULA**  
 angled at 9 mm, 45°  
 closed tip with sideport, textured  
 23 gauge / 0.6 mm  
 10 pcs. per box, sterile



**G-34280** *SIMCOE*  
**SINGLE-USE I/A CANNULA**  
 0.4 mm diameter aspiration port  
 front opening irrigation port  
 23 gauge / 0.64 mm  
 10 pcs. per box, sterile

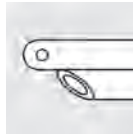

**G-15197** **SINGLE-USE IRRIGATION CANNULA**  
 for viscocanalostomy  
 26 gauge / 0.45 mm shaft  
 35 gauge / 0.21 mm angled tip  
 5 mm tapered tube  
 5 pcs. per box, sterile



**G-34335** **SINGLE-USE IRRIGATION CANNULA**  
 for topical irrigation  
 with bulbous tip, straight  
 length 60 mm, 3 mm diameter tip  
 50 pcs. per box, sterile



**G-80975** **SINGLE-USE INJECTION CANNULA**  
 for EasyGas®  
 30 gauge / 0.3 x 12 mm  
 100 pcs. per box, sterile





**G-34400 SINGLE-USE BIMANUAL I/A HANDPIECE SET**

consisting of:  
 · Irrigation Handpiece, irrigation ports 2 x 0.6 mm  
 · Aspiration Handpiece, aspiration port 0.4 mm  
 · rough tip tube 21 gauge / 0.8 mm  
 5 pcs. per box, sterile

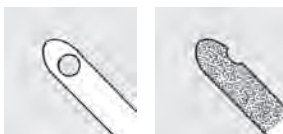

**G-34289 SINGLE-USE BACKFLUSH HANDPIECE**

with silicone chamber, Luer-Lock  
 10 pcs. per box, sterile



**G-34806 SINGLE-USE SILICONE CHAMBER**

for backflush handpieces G-31805,  
 G-37000 and G-37002  
 10 pcs. per box, sterile



**G-34275 SINGLE-USE BACKFLUSH CANNULA**

inside diameter 25 gauge / 0.5 mm  
 outside diameter 21 gauge / 0.8 x 35 mm  
 10 pcs. per box, sterile



**SINGLE-USE BACKFLUSH CANNULA**

blunt tip  
 5 pcs. per box, sterile

**G-34291**

20 gauge / 0.9 mm

**G-34296**

23 gauge / 0.6 mm

**G-34299**

25 gauge / 0.5 mm



**SINGLE-USE BACKFLUSH CANNULA**

with silicone brush  
 5 pcs. per box, sterile

**G-34293**

20 gauge / 0.9 mm

**G-34294**

23 gauge / 0.6 mm

**G-34297**

25 gauge / 0.5 mm



**SINGLE-USE BACKFLUSH CANNULA**

with silicone tip  
 5 pcs. per box, sterile  
**G-34292** 20 gauge / 0.9 mm  
**G-34295** 23 gauge / 0.6 mm  
**G-34298** 25 gauge / 0.5 mm

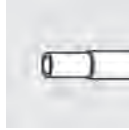

**G-34285 SINGLE-USE PFCL CANNULA**

for injection of heavy fluids  
 dual bore, coaxial  
 23 gauge / 0.64 mm  
 10 pcs. per box, sterile



**SINGLE-USE CANNULA**

to inject silicone oil  
 10 pcs. per box, sterile  
**G-34497** 20 gauge / 0.9 mm x 8 mm  
**G-34498** 23 gauge / 0.6 mm x 8 mm



**G-33482 SINGLE-USE INJECTION CANNULA**

for viscous fluids, self-retaining, 4.0 mm tip  
 with 25 cm PVC tube  
 Luer-Lock plastic adapter  
 20 gauge / 0.9 mm  
 5 pcs. per box, sterile



**G-33463 SINGLE-USE INFUSION CANNULA**

self-retaining, 4.0 mm tip  
 with 25 cm silicone tube  
 Luer-Lock plastic adapter  
 20 gauge / 0.9 mm  
 5 pcs. per box, sterile



**SINGLE-USE INFUSION CANNULA**

with 25 cm silicone tube  
 Luer-Lock plastic adapter  
 20 gauge / 0.9 mm  
 5 pcs. per box, sterile  
**G-33468** beveled tip, 4.0 mm  
**G-33469** beveled tip, 6.0 mm



**G-33462 SINGLE-USE INFUSION CANNULA**

4.0 mm beveled tip  
 with 25 cm PVC tube  
 Luer-Lock plastic adapter  
 25 gauge / 0.5 mm  
 10 pcs. per box, sterile



CANNULAS (BACKFLUSH WITH SILICONE TIP, PFCL, SILICONE OIL, INFUSION)

**SINGLE-USE INJECTION CANNULA**

for viscous fluids  
with 1 metal sleeve, Luer-Lock plastic adapter  
and 25 cm PVC tube  
20 gauge / 0.9 mm  
5 pcs. per box, sterile  
beveled tip, 4.0 mm  
G-33488  
beveled tip, 6.0 mm  
G-33489



G-34480

**SINGLE-USE INJECTION CANNULA**

for viscous fluids  
4.0 mm beveled tip  
with 2 metal sleeves, Luer-Lock plastic adapter  
and 25 cm silicone tube  
19 gauge / 1.1 mm  
10 pcs. per box, sterile



G-34492

*KIRCHHOF*

**SINGLE-USE INJECTION CANNULA**

for gas / viscous fluids  
5.0 mm beveled tip with 4 infusion side ports  
2 metal sleeves, Luer-Lock plastic adapter and  
40 cm silicone tube  
20 gauge / 0.9 mm  
10 pcs. per box, sterile



G-32696

**SINGLE-USE PRESSURE TUBE**

for injection of viscous fluid, Luer-Lock female / male  
10 pcs. per box, sterile



G-31891

**SINGLE-USE SYRINGE**

Luer-Lock, 10 ml, sterile



G-31520

**SINGLE-USE MINI FILTER**

0.1 µm, sterile



CANNULAS (INJECTION, VISCOUS FLUIDS, GAS)

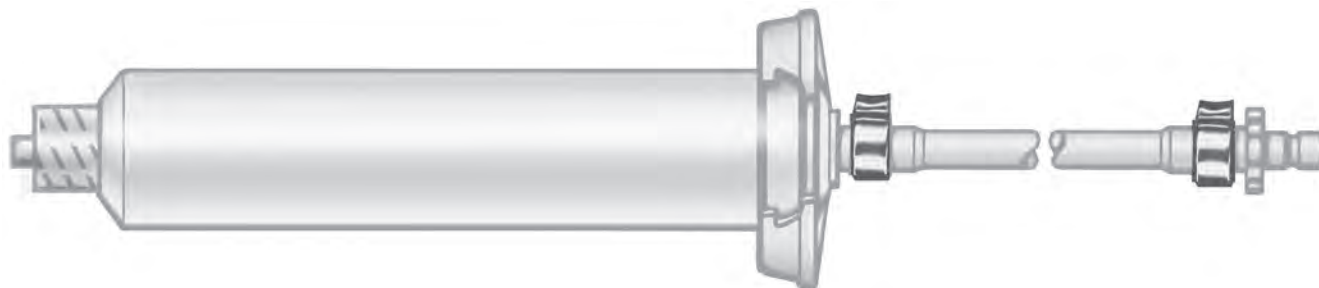

**G-28766** **SINGLE-USE OIL INJECTION SYSTEM**  
to inject silicone oil pneumatically,  
with protective cover for glass syringe,  
pressure tube fits megaTRON® S3 / S4 HPS and  
Pentasy® 2, sterile

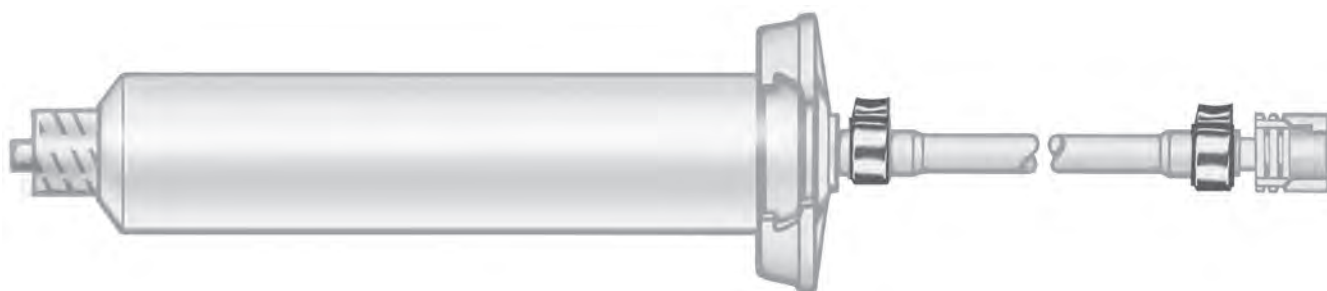

**G-28767** **SINGLE-USE OIL INJECTION SYSTEM**  
to inject silicone oil pneumatically,  
with protective cover for glass syringe,  
pressure tube fits megaTRON® and Accurus® ,sterile

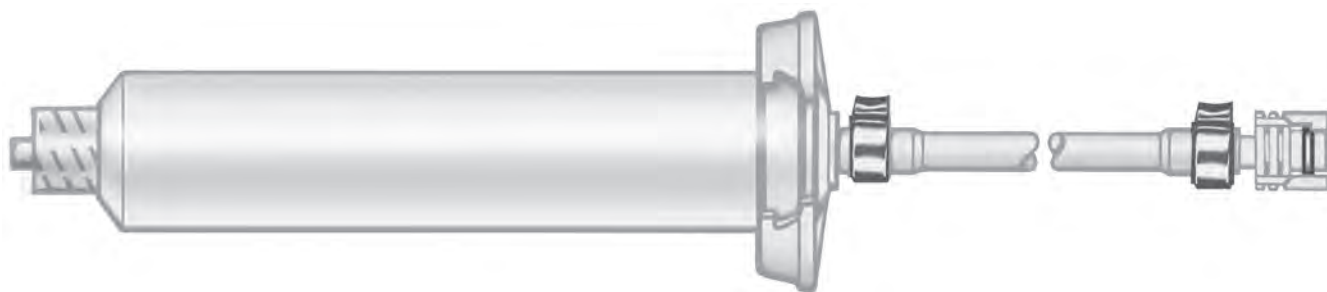

**G-28768** **SINGLE-USE OIL INJECTION SYSTEM**  
to inject silicone oil pneumatically,  
with protective cover for glass syringe,  
pressure tube fits Millennium® , sterile

- G-23991**     **SINGLE-USE THREE-WAY STOP COCK**  
2x Luer-Lock female, 1x Luer-Lock male  
plastic, sterile



- G-32700**     **SCALPEL HANDLE**

**SCALPEL SURGICAL BLADES**

100 pcs. per box, sterile

- G-32705**     #11, curved cutting edge

- G-32710**     #15, straight edge and pointed tip



- G-18127**     **ABSORBENT SWABS**  
17 mm long  
box of 20 pouches  
10 swabs per pouch  
sterile

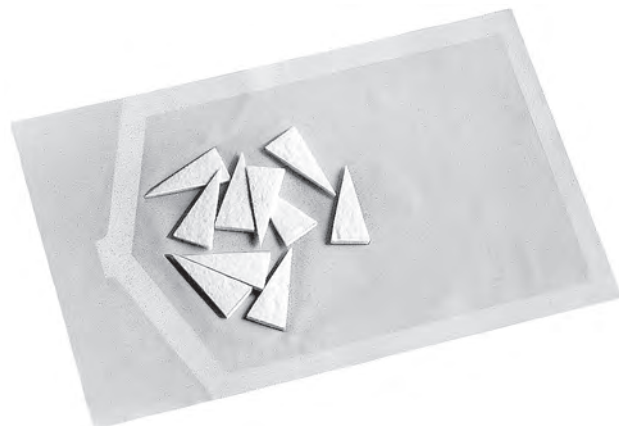

- G-33786**     **MARKING PEN**  
gentian violet  
dual tip, fine and broad  
to ink corneal instruments  
20 pcs. per box, sterile



**G-34602 SILICONE TIRE (276 STYLE)**  
 asymmetrical, 7.0 mm wide  
 2.5 mm groove  
 5 pcs. per box, sterile

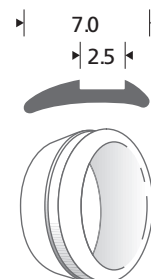

**G-34610 SILICONE TIRE (287 STYLE)**  
 convex, 7.0 mm wide  
 2.5 mm groove  
 5 pcs. per box, sterile

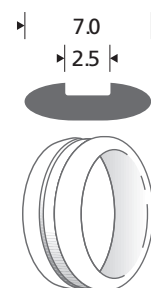

**G-34616 SILICONE TIRE (277 STYLE)**  
 concave, 7.0 mm wide  
 2.5 mm groove  
 5 pcs. per box, sterile

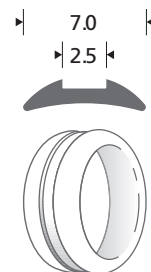

**G-34618 SILICONE TIRE (279 STYLE)**  
 concave, 9.0 mm wide  
 2.5 mm groove  
 5 pcs. per box, sterile

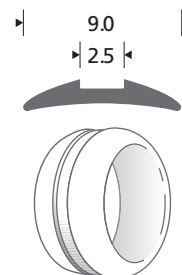



**G-34620 SILICONE CIRCLING BAND (40 STYLE)**

0.75 mm x 2.0 mm  
125 mm long  
5 pcs. per box, sterile

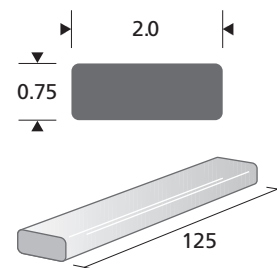
**G-34622 SILICONE CIRCLING BAND (240 STYLE)**

0.6 mm x 2.5 mm  
125 mm long  
5 pcs. per box, sterile

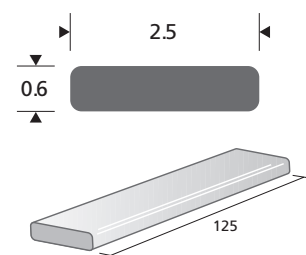
**G-34624 SILICONE STRIP (41 STYLE)**

0.75 mm x 3.5 mm  
125 mm long  
5 pcs. per box, sterile

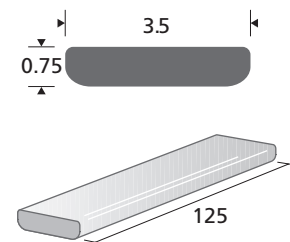
**G-34626 SILICONE STRIP (42 STYLE)**

1.25 mm x 4.0 mm  
125 mm long  
5 pcs. per box, sterile

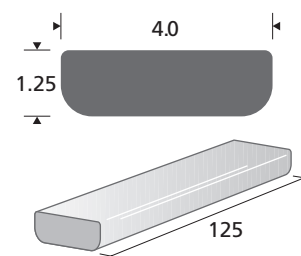

**G-34632 GROOVED SILICONE STRIP (31 STYLE)**  
 2.0 mm x 4.5 mm  
 125 mm long, 2.0 mm groove  
 5 pcs. per box, sterile

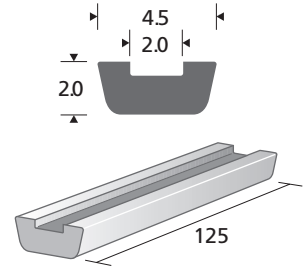

**G-34634 GROOVED SILICONE STRIP (32 STYLE)**  
 2.5 mm x 5.0 mm  
 125 mm long, 2.0 mm groove  
 5 pcs. per box, sterile

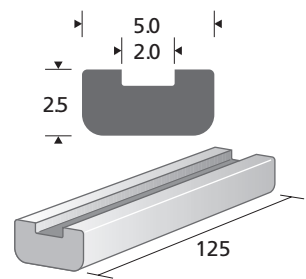

**G-34636 GROOVED SILICONE STRIP (219 STYLE)**  
 1.25 mm x 4.5 mm  
 100 mm long, 2.5 mm groove  
 5 pcs. per box, sterile

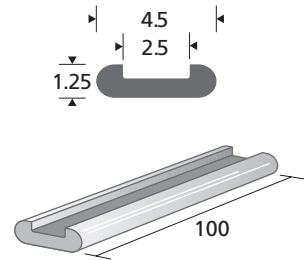

**G-34644 SILICONE SLEEVE (72 STYLE)**  
 1.5 mm inside diameter  
 2.4 mm outside diameter  
 30 mm long  
 5 pcs. per box, sterile

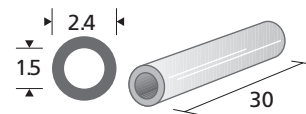

**G-34642 SILICONE SLEEVE (70 STYLE)**  
 1.0 mm inside diameter  
 2.1 mm outside diameter  
 30 mm long

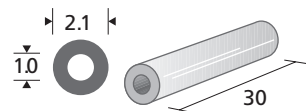

**G-34646 SILICONE SLEEVE (270 STYLE)**  
 0.76 mm inside diameter  
 1.65 mm outside diameter  
 30 mm long  
 5 pcs. per box, sterile

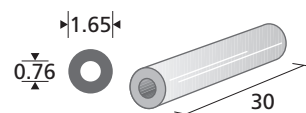

SILICONE STRIPS · SILICONE SLEEVES

**G-34645 OVAL SILICONE SLEEVE (3083 STYLE)**

1.5 mm inside diameter  
2.5 mm outside diameter  
5 mm long  
5 pcs. per box, steril

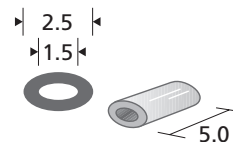

**G-34647 OVAL SILICONE SLEEVE (3084 STYLE)**

1.5 mm inside diameter  
3.75 mm outside diameter  
5 mm long  
5 pcs. per box, steril

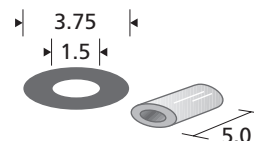

**G-34654 SILICONE WEDGE (137 STYLE)**

2.5 mm groove  
5 pcs. per box, sterile

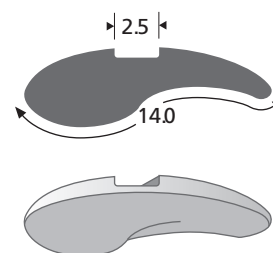

**G-34650 MERIDIONAL SILICONE IMPLANT (106 STYLE)**

6.5 mm wide  
10.5 mm long  
5 pcs. per box, sterile

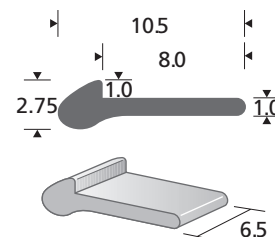

**G-34656 ROUND SILICONE SPONGE IMPLANT (503 STYLE)**

3.0 mm diameter  
80 mm long  
5 pcs. per box, sterile

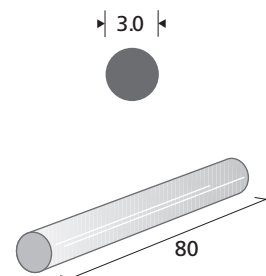

**G-34658**     **ROUND SILICONE SPONGE IMPLANT (504 STYLE)**  
 4.0 mm diameter  
 80 mm long  
 5 pcs. per box, sterile

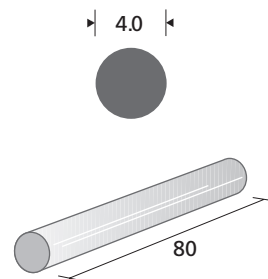

**G-34660**     **ROUND SILICONE SPONGE IMPLANT (505 STYLE)**  
 5.0 mm diameter  
 80 mm long  
 5 pcs. per box, sterile

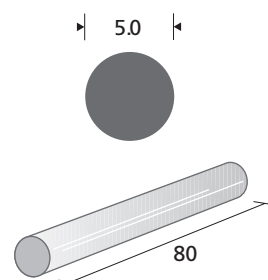

**G-34664**     **OVAL SILICONE SPONGE IMPLANT (501 STYLE)**  
 2.5 mm x 4.0 mm  
 80 mm long  
 5 pcs. per box, sterile

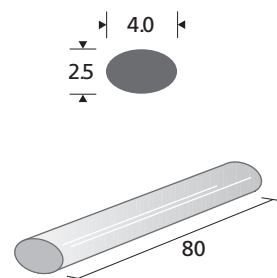

**G-34666**     **OVAL SILICONE SPONGE IMPLANT (506 STYLE)**  
 3.0 mm x 5.0 mm  
 100 mm long  
 5 pcs. per box, sterile

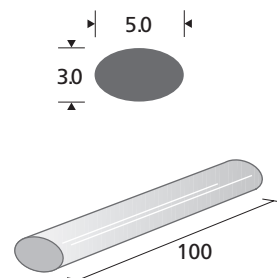

**G-34668 OVAL SILICONE SPONGE IMPLANT (507 STYLE)**

5.5 mm x 7.5 mm  
80 mm long  
5 pcs. per box, sterile

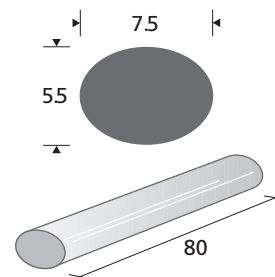
**G-34672 GROOVED SILICONE SPONGE IMPLANT (506G STYLE)**

3.0 mm x 5.0 mm  
80 mm long, 2.5 mm groove  
5 pcs. per box, sterile

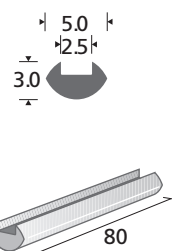
**G-34674 GROOVED SILICONE SPONGE IMPLANT (507G STYLE)**

5.5 mm x 7.5 mm  
80 mm long, 2.5 mm groove  
5 pcs. per box, sterile

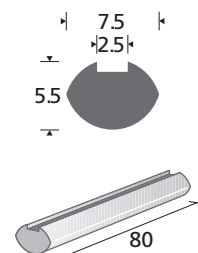
**G-34684 SEMI-CIRCULAR SILICONE SPONGE IMPLANT (510 STYLE)**

2.5 mm x 5.0 mm  
80 mm long  
5 pcs. per box, sterile

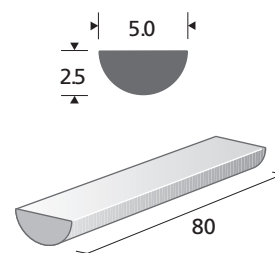

**G-34686 SEMI-OVAL SILICONE SPONGE IMPLANT (511 STYLE)**

2.75 mm x 7.5 mm  
80 mm long  
5 pcs. per box, sterile

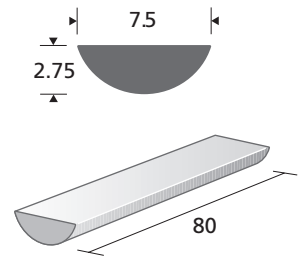

**G-34688 SEMI-OVAL SILICONE SPONGE IMPLANT (515 STYLE)**

3.33 mm x 5.0 mm  
80 mm long  
5 pcs. per box, sterile

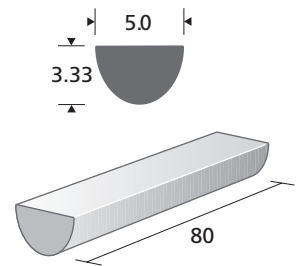

**G-34690 SEMI-OVAL SILICONE SPONGE IMPLANT (517 STYLE)**

3.66 mm x 7.5 mm  
80 mm long  
5 pcs. per box, sterile

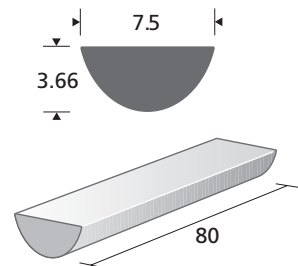

**G-34710 BONN INJECTION SET**

single-use set for intravitreal injection  
consisting of:

- measuring and fixation instrument, 3.5 / 4.0 mm
  - eye speculum
  - irrigation cannula
  - cannula 0.9 x 70 mm
  - syringe 1 ml
  - syringe 10 ml
  - eye drape with pre-cut adhesive incise-film 140 x 140 cm
  - absorbent swab (3x)
  - gauze compress 10 x 10 (2x)
  - protective cover 60 x 60 cm
- 10 pcs. per box, sterile



SILICONE SPONGE IMPLANTS · BONN INJECTION SET

## MISCELLANEOUS



CAPSULE TENSION RING INJECTORS.....	<b>241</b>
PUPIL DILATOR INJECTOR.....	<b>241</b>
LACRIMAL / DCR.....	<b>242</b>
LASEK.....	<b>243</b>
DIAMOND BURR.....	<b>244</b>
VITRECTOMY LENSES.....	<b>244</b>
EYE SHIELD.....	<b>245</b>
EYE SPHERES.....	<b>245</b>
CAUTERY.....	<b>246</b>







**G-32955**

**INJECTOR**

for capsular tension ring  
shaft diameter 1.2 mm  
for 1.9 mm incisions  
shaft length 30 mm  
overall length 156 mm



**G-32960**

**INJECTOR**

for *MORCHER* capsular tension ring  
shaft diameter 1.2 mm  
for 1.9 mm incisions  
shaft length 30 mm  
overall length 156 mm



**G-32965**

**INJECTOR**

for *MORCHER* capsular ring  
shaft diameter 1.6 mm  
for 2.4 - 2.5 mm incisions  
shaft length 30 mm  
overall length 156 mm



**G-32970**

**INJECTOR**

for *MORCHER* pupil dilator  
overall length 140 mm



**G-31810** *FRIEDMANN*  
**RONGEUR**  
overall length 140 mm



**G-32355** **NASAL SPECULUM**  
overall length 150 mm



**G-33125** *MEAD*  
**HAMMER**  
300 g, lead filled  
overall length 190 mm



**G-18630** *HEIDELBERG MODEL*  
**ELEVATORIUM**  
overall length 143 mm



**G-18620** *HEIDELBERG MODEL*  
**RASPATORY**  
overall length 155 mm





**G-18240** *WEST*  
**BONE CHISEL**  
for lacrimal sac  
flat, 5.0 mm wide  
overall length 160 mm



**G-18245** *WEST*  
**BONE GOUGE**  
for lacrimal sac  
concave, 5.0 mm wide  
overall length 162 mm



**G-33650** *ELSA*  
**LASEK TREPHINE**  
with crosshairs  
overall length 100 mm  
**G-33652** 8.0 mm  
9.0 mm



**G-33655** *LOHMANN*  
**LASEK FUNNEL**  
with crosshairs  
overall length 100 mm  
**G-33657** 8.5 mm  
9.5 mm



**G-32313** *WRIGHT*  
**FASCIA NEEDLE**  
overall length 115 mm

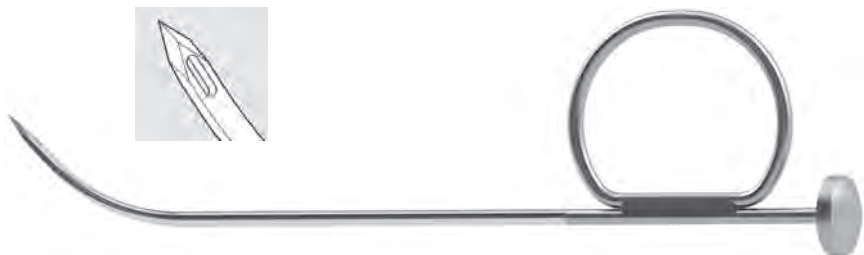

BONE CHISELS · LASEK FUNNEL · FASCIA NEEDLE



- DIAMOND BURR**  
top, inside, outside coat
- G-18300** 8.0 mm
  - G-18301** 9.0 mm
  - G-18302** 10.0 mm

- G-36000** *KILP*  
**LENS**  
60 D flat, field of vision 20°, silicone ring  
central posterior pole and central vitreous body



- G-36010** *LANDERS*  
**LENS**  
93 D, biconcave with silicone ring  
clear view of fundus in air-filled phakic eye



- G-36015** *MACHEMER*  
**LENS**  
with silicone ring to magnify structures  
in vitreous cavity or on retinal surface



- G-36020** *PEYMAN*  
**LENS**  
wide field of vision 30°, with silicone ring  
for central fundus and central vitreous body



- G-36025** *TOLENTINO*  
**LENS**  
prism 20° with silicone ring  
posterior peripheral fundus and  
posterior peripheral vitreous body



- G-36030** *TOLENTINO*  
**LENS**  
prism 30° with silicone ring  
peripheral viewing beyond the equator



- G-36045** **SILICONE REPLACEMENT RING**  
for *KILP* lens G-36000



DIAMOND BURR · VITRECTOMY LENSES

**G-36050 SILICONE REPLACEMENT RING**  
for lenses from G-36010 to G-36035



**G-36065 LENS HANDLE RING**  
for lenses without silicone ring  
to suture on to sclera  
for G-36000



**G-31105 EYESHIELD**  
plastic, transparent for use on both eyes  
100 pcs. per bag



*CIBIS*  
**EYE SPHERE**

**G-20216** 16 mm  
**G-20217** 17 mm  
**G-20218** 18 mm  
**G-20219** 19 mm  
**G-20220** 20 mm



*HARMS*  
**EYE SPHERE**

**G-20316** 16 mm  
**G-20317** 17 mm  
**G-20318** 18 mm  
**G-20319** 19 mm  
**G-20320** 20 mm



*WALSER*  
**EYE SPHERE**

**G-20416** 16 mm  
**G-20417** 17 mm  
**G-20418** 18 mm  
**G-20419** 19 mm  
**G-20420** 20 mm

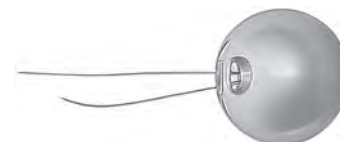

**G-19820**     **BATTERY CAUTERY**  
with spare tip  
and batteries  
overall length with  
spare tip 155 mm



9/10

**G-19825**     **SPARE TIP**  
for battery cauterization G-19820  
overall length 50 mm



**G-31900**     *KUHN*  
**INTRAOCULAR MAGNET**  
30 mm shaft, 1.9 mm outside diameter  
4 mm magnetic tip  
overall length 90 mm



## STERILIZATION CONTAINERS AND ADAPTERS

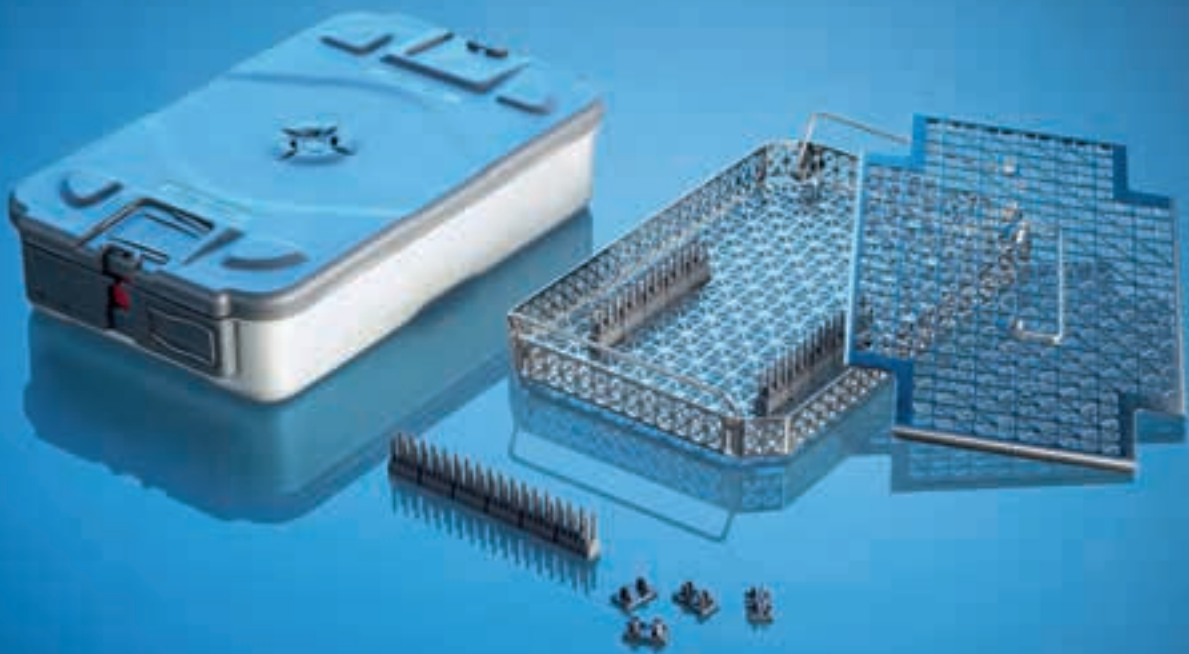

MICROSTOP <sup>®</sup> .....	<b>249</b>
STEEL CASES .....	<b>252</b>
TRAYS & RACKS FOR STEEL CASES .....	<b>256</b>
SILICONE STRIPS & MATS .....	<b>257</b>
SMALL CASES .....	<b>258</b>
STERISAFE <sup>®</sup> DURO .....	<b>259</b>
ADAPTERS .....	<b>264</b>





**G-39745**      **MICROSTOP<sup>®</sup>**  
**CONTAINER LOW**  
for one tray  
outside dimensions: 310 x 189 x 70 mm  
inside dimensions: 283 x 177 x 50 mm



**G-39750**      **MICROSTOP<sup>®</sup>**  
**CONTAINER HIGH**  
for two trays  
outside dimensions: 310 x 189 x 90 mm  
inside dimensions: 283 x 177 x 70 mm



**MICROSTOP<sup>®</sup>**  
**TRAY MINI**  
29 mm, low  
size: 277 x 172 x 29 mm  
**G-39783**      without lid  
**G-39786**      with lid



**MICROSTOP<sup>®</sup>**  
**TRAY MINI**  
38 mm, high  
size: 277 x 172 x 38 mm  
**G-39785**      without lid  
**G-39784**      with lid



MICROSTOP<sup>®</sup>

**G-39787**      **MICROSTOP®**  
**TRAY LID MINI**  
 size: 277 x 172 mm  
 for G-39783 and G-39785



**G-39782**      **MICROSTOP®**  
**RETAINER ELEMENT**  
 for MICROSTOP® tray mini  
 nap Style, 120 mm  
 separable into 6 single elements  
**G-39782**      29 mm, low  
**G-39789**      38 mm, high



**G-39788**      **MICROSTOP®**  
**CLIP FOR RETAINER ELEMENTS**  
 G-39782 and G-39789  
 10 pcs. per bag



**G-39791**      **MICROSTOP®**  
**ID LABEL**  
 for tray, aluminium  
 customized labeling  
 silver-colored



**G-39741**      **MICROSTOP®**  
**LABEL**  
 for lid, customized labeling



**G-39746**      **MICROSTOP®**  
**ID LABEL**  
 for front, customized labeling



**MICROSTOP<sup>®</sup>  
LOGISTIC FRAME**  
for lid to use with labels

- G-39753** color: red
- G-39754** color: blue
- G-39755** color: green



**G-39762** **MICROSTOP<sup>®</sup>  
SEAL**  
with indicator  
1000 pcs. per box

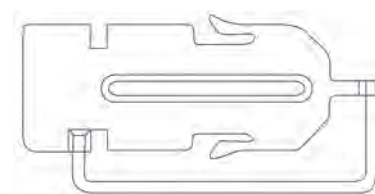

**G-39764** **MICROSTOP<sup>®</sup>  
TAG**  
with indicator  
1000 pcs. per box



**G-39680** **PROTOCOL CARDS**  
for ERGO-SAFE tray  
320 pcs. per box

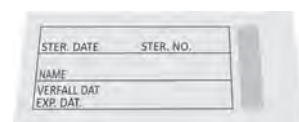

**G-19822**

**STERILIZATION CASE**

- for steam sterilization
- outside dimensions: 220 x 165 x 55 mm
- textile filter in lid and base
- silicone seal
- perforated insert without edge
- perforated silicone tray G-32785
- 2 labels with clamp



**G-19823**

**STERILIZATION CASE**

- for steam sterilization
- outside dimensions: 220 x 165 x 75 mm
- textile filter in lid and base
- silicone seal
- perforated insert without edge
- perforated silicone tray G-32785
- 2 labels with clamp



**G-28151**

**STERILIZATION CASE**

- for steam sterilization
- outside dimensions: 300 x 220 x 75 mm
- textile filter in lid and base
- silicone seal
- perforated insert without edge
- 3 silicone burl strips
- 2 silicone paddings in lid
- 2 labels with clamp



**G-28150**

**STERILIZATION CASE**

- for steam sterilization
- outside dimensions: 300 x 220 x 75 mm
- textile filter in lid and base
- silicone seal in the lid
- perforated insert with edge, subdivided, with perforated silicone plate and perforated silicone tray
- silicone insert, small, with perforated silicone tray
- 2 labels with clamp



**G-19876****STERILIZATION CASE**

- for steam sterilization  
 outside dimensions: 300 x 220 x 55 mm  
 - textile filter in lid and base  
 - silicone seal  
 - perforated insert without edge  
 - 3 silicone burl strips  
 - 2 silicone paddings in lid  
 - 2 labels with clamp

**G-19856****STERILIZATION CASE**

- for steam sterilization  
 outside dimensions: 300 x 220 x 55 mm  
 - paper filter with quick-clasp in lid and base  
 - silicone seal in the lid  
 - without insert and profile strips  
 - 2 labels with clamp

**G-19843****STERILIZATION CASE**

- for steam sterilization  
 outside dimensions: 300 x 220 x 75 mm  
 - textile filter in lid and base  
 - silicone seal  
 - perforated insert with edge  
 - perforated silicone plate  
 - perforated insert without edge  
 - 3 silicone burl strips  
 - 2 silicone paddings in lid  
 - 2 labels with clamp



**G-19842**

**STERILIZATION CASE**

- for steam sterilization
- outside dimensions: 300 x 220 x 75 mm
- textile filter in lid and base
- silicone seal in the lid
- perforated insert with edge and perforated silicone plate
- perforated insert with edge perforated silicone plate and silicone instrument tray
- 2 labels with clamp



**G-19877**

**STERILIZATION CASE**

- for steam sterilization
- outside dimensions: 400 x 290 x 55 mm
- textile filter in lid and base
- silicone seal
- perforated insert without edge
- 4 silicone burl strips
- 3 silicone paddings in lid
- 2 labels with clamp



**G-19892**

**STERILIZATION CASE**

- for steam sterilization
- outside dimensions: 400 x 290 x 70 mm
- textile filter in lid and base
- silicone seal in the lid
- 2 perforated inserts without edge with 4 silicone nap strips each
- 3 silicone profile strips at the base of the upper perforated insert
- 3 silicone profile strips in the lid
- 2 labels with clamp



**G-19894**

**STERILIZATION CASE**

- for steam sterilization
- outside dimensions: 400 x 290 x 70 mm
- textile filter in lid and base
- silicone seal in the lid
- perforated insert without edge with 4 silicone nap strips
- perforated insert with edge and silicone nap plate
- 3 silicone profile strips in the lid
- 2 labels with clamp



**G-19890**

**STERILIZATION CASE**

- for steam sterilization
- outside dimensions: 495 x 270 x 70 mm
- textile filter in lid and base
- silicone seal in the lid
- perforated insert with edge 4 silicone nap strips and lateral compartment (240 x 110 x 40 mm),
- 3 silicone profile strips in the lid
- 2 labels with clamp



**PERMANENT TEXTILE FILTER**

for steam sterilization cases

**G-31650**

for G-19822, G-19823

**G-31651**

for G-19841, G-19842, G-19843, G-19876, G-28150, G-28151

**G-31652**

6 perforations, for G-19877, G-19892, G-19894

**G-31656**

for G-19877

**G-31661**

for G-19890



**G-31649**

**INDICATOR**

for steam sterilization, slim  
1000 pcs. per box

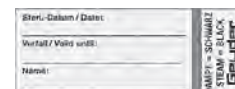

**G-32675**     **SILICONE TRAY**  
with bottom  
outside dimensions: 160 x 85 x 20 mm



**G-32660**     **STERILIZATION RACK**  
for 12 cannulas, silicone  
outside dimensions: 85 x 56 x 8 mm



**G-19870**     **STERILIZATION RACK**  
for 10 instruments with handle, silicone  
outside dimensions: 160 x 85 x 20 mm

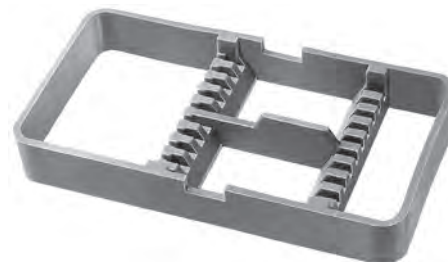

**G-32785**     **SILICONE PERFORATED TRAY**  
outside dimensions: 194 x 135 x 24 mm

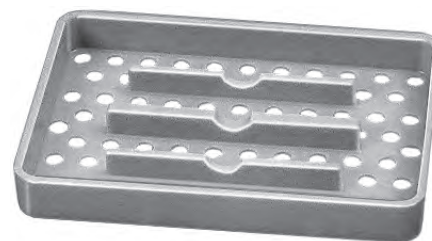



- G-39650**     **STERILIZATION CASE**  
 for steam sterilization, plastic  
 for 6 vitreoretinal instruments  
 outside dimensions: 210 x 130 x 26 mm



- G-32676**     **SILICONE NAP STRIP BLUE**  
 340 x 30 mm



- G-32677**     **SILICONE STRIP BLUE**  
 350 mm long



- SILICONE BURL MAT**  
 perforated
- G-19866**     240 x 230 mm  
**G-19865**     300 x 150 mm  
**G-19867**     470 x 245 mm



- G-19899**     **SILICONE PLATE**  
 perforated, 270 x 185 mm  
 for hot air sterilization cases  
 G-19841, G-19842, G-19843,  
 G-19846, G-19847

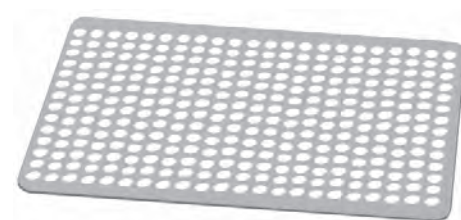

**G-31657 SAFETY SEAL**  
for steam sterilization cases  
100 pcs. per box



**G-31659 SEAL**  
for hot-air sterilization cases  
100 pcs. per box



**G-32695 SILICONE CLOSURE**  
17 cm long



**G-33080 STERILIZATION CASE**  
for steam sterilization, plastic, for 5 instruments with handle  
outside dimensions: 160 x 85 x 20 mm



**G-33090 STERILIZATION CASE**  
for one instrument or diamond knife, plastic  
outside dimensions: 160 x 60 x 20 mm



**G-33100 STERILIZATION CASE**  
for one vitreoretinal instrument, plastic  
outside dimensions: 195 x 60 x 25 mm

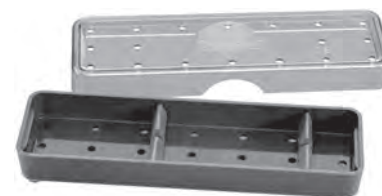

**G-36090**      **STERILIZATION CASE**  
plastic, for 6 vitreoretinal lenses



**G-39527**      **STERISAFE<sup>®</sup> DURO A4 PLUS**  
container for steam, gas (EO, FO) and plasma  
sterilization, without trays and strips  
outside dimensions: 290 x 190 x 70 mm  
inside dimensions: 265 x 165 x 60 mm



**G-39526**      **STERISAFE<sup>®</sup> DURO A4 PLUS COMPLETE SET**  
container for steam, gas (EO, FO) and plasma  
sterilization, including:  
1 x Sterisafe<sup>®</sup> wire basket A4-30  
5 x Sterisafe<sup>®</sup> silicone retainer strips 230 mm  
1 x Sterisafe<sup>®</sup> metal tray A4-30  
outside dimensions: 290 x 190 x 70 mm  
inside dimensions: 265 x 165 x 60 mm

**G-39525**      **STERISAFE<sup>®</sup> DURO A4**  
container for steam, gas (EO, FO) and plasma  
sterilization  
outside dimensions: 290 x 190 x 60 mm  
inside dimensions: 265 x 165 x 49 mm



**G-39528**      **STERISAFE<sup>®</sup> DURO A6**  
container for steam, gas (EO, FO) and plasma  
sterilization  
outside dimensions: 190 x 110 x 60 mm  
inside dimensions: 165 x 92 x 49 mm



STERISAFE<sup>®</sup> DURO

**G-39543 STERISAFE® DURO WIRE BASKET A4-30**

outside dimensions: 260 x 163 x 30 mm  
inside dimensions: 249 x 157 x 23 mm



**G-39541 STERISAFE® DURO METAL TRAY A4-15**

outside dimensions: 260 x 163 x 15 mm  
inside dimensions: 249 x 157 x 11 mm



**G-39542 STERISAFE® DURO METAL TRAY A4-30**

outside dimensions: 260 x 163 x 30 mm  
inside dimensions: 249 x 157 x 26 mm



**G-39549 STERISAFE® DURO WIRE BASKET A6-30**

outside dimensions: 162 x 90 x 30 mm  
inside dimensions: 156 x 80 x 23 mm



**G-39548 STERISAFE® DURO METAL TRAY A6-15**

outside dimensions: 162 x 90 x 15 mm  
inside dimensions: 156 x 80 x 11 mm



**G-39545**      **STERISAFE<sup>®</sup> SILICONE RETAINER STRIP 75**  
for Sterisafe<sup>®</sup> DURO A4 and A6  
length: 75 mm



**G-39546**      **STERISAFE<sup>®</sup> SILICONE RETAINER STRIP 145**  
for Sterisafe<sup>®</sup> DURO A4 and A6  
length: 145 mm



**G-39547**      **STERISAFE<sup>®</sup> SILICONE RETAINER STRIP 230**  
for Sterisafe<sup>®</sup> DURO A4 and A6  
length: 230 mm



**G-39501**      **STERISAFE<sup>®</sup> FILTER**  
A4 10 pcs. per box  
**G-39511**      A6 10 pcs. per box

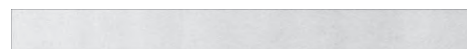

**G-39530**      **STERISAFE<sup>®</sup> FILTER TAG EXPIRATION DATE**  
10 pcs. per box



**G-39535**      **SEAL / LABEL**  
seal with color indicator and blank label  
2000 pcs. per box

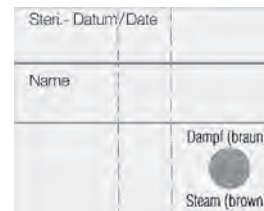

**G-39540**      **SECURITY SEAL**  
100 pcs. per box



**G-39502**      **STERISAFE® SILICONE BURL MAT**      A4  
**G-39512**      A6

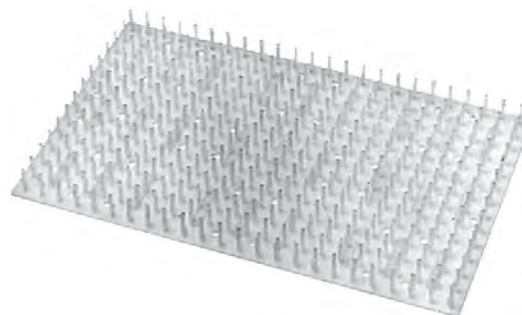

**G-39503**      **STERISAFE® SILICONE GRID INSERT**      A4  
**G-39513**      A6

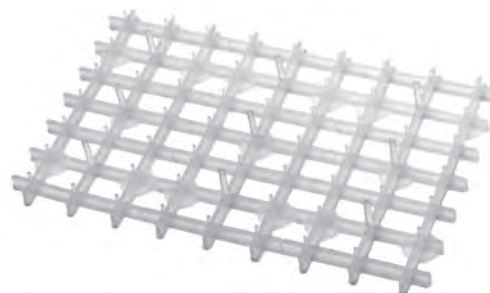

**G-39504**      **STERISAFE® METAL GRID INSERT**      A4  
**G-39514**      A6



**G-39505**      **STERISAFE<sup>®</sup> METAL GRID INSERT**  
with 2 silicone burl strips

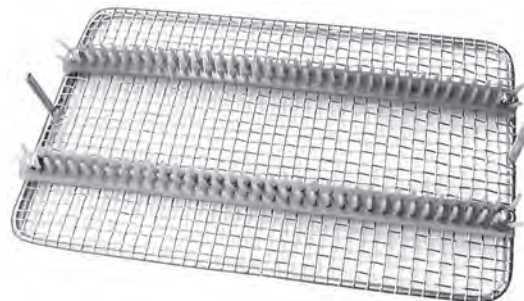

**G-31670**      **MELAG METAL GRID INSERT**  
with 2 silicone nap strips  
outside dimensions: 370 x 147 x 50 mm  
for MELAG sterilizing case

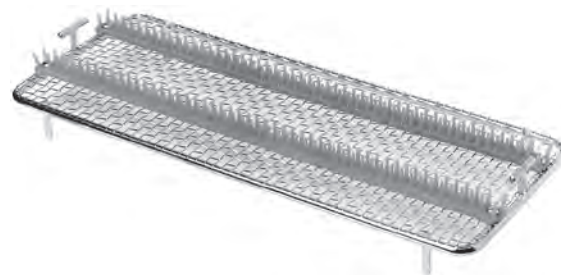

**G-31028**      **CLEANING ADAPTER**  
for ultrasonic handpieces (irrigation connector)  
Luer female / male



**G-31029**      **CLEANING ADAPTER**  
for ultrasonic handpieces (aspiration connector)  
Luer female / female



**G-31021**      **CLEANING ADAPTER**  
for ultrasonic tips



**G-31013**      **CLEANING ADAPTER**  
for *HATTENBACH* 25 gauge hybrid instruments  
(G-32944, G-32947 and G-32948)

**G-22636**      **ADAPTER**  
for *PAPST* I/A handpiece  
light model



**G-31025**      **ASPIRATION ADAPTER**  
metal  
for cleaning I/A handpieces  
Luer-Lock female / female



**G-31026**      **ASPIRATION ADAPTER**  
plastic  
for cleaning I/A handpieces  
Luer-Lock female / female





**G-31016**      **CLEANING ADAPTER**  
for diamond knives, small



**G-31017**      **CLEANING ADAPTER**  
for diamond knives, large



**G-31022**      **CLEANING ADAPTER**  
for G-37010 - G-37080



**G-31031**      **CLEANING ADAPTER**  
for aspiration handpiece G-37100 and G-37105  
Luer-Lock female / silicone tube  
2.1 x 1.0 mm



**G-31018**      **CLEANING ADAPTER**  
for PFCL cannula G-33055  
Luer-Lock female / silicone tube



**G-31024**      **CLEANING ADAPTER**  
for eye specula with aspiration



**G-31023**      **CLEANING ADAPTER**  
for eye specula with aspiration  
G-33141, G-33142 and G-33143



**G-31027**      **CLEANING ADAPTER**  
for *JUENEMANN* probes





**G-31034**      **CLEANING ADAPTER**  
for foreign body instruments G-14530, G-14540, G-14550  
Luer-Lock female

**G-31014**      **CLEANING ADAPTER**  
for cannulas G-33057 and G-33059  
Luer-Lock female



**G-36604**      **CLEANING ADAPTER**  
for rotatable and interchangeable tips



PLEASE READ YOUR INSTRUMENT'S  
CLEANING INSTRUCTIONS OR ASK  
YOUR LOCAL SALES REPRESENTATIVE  
FOR THE RIGHT CLEANING ADAPTER.

# 19

SETS

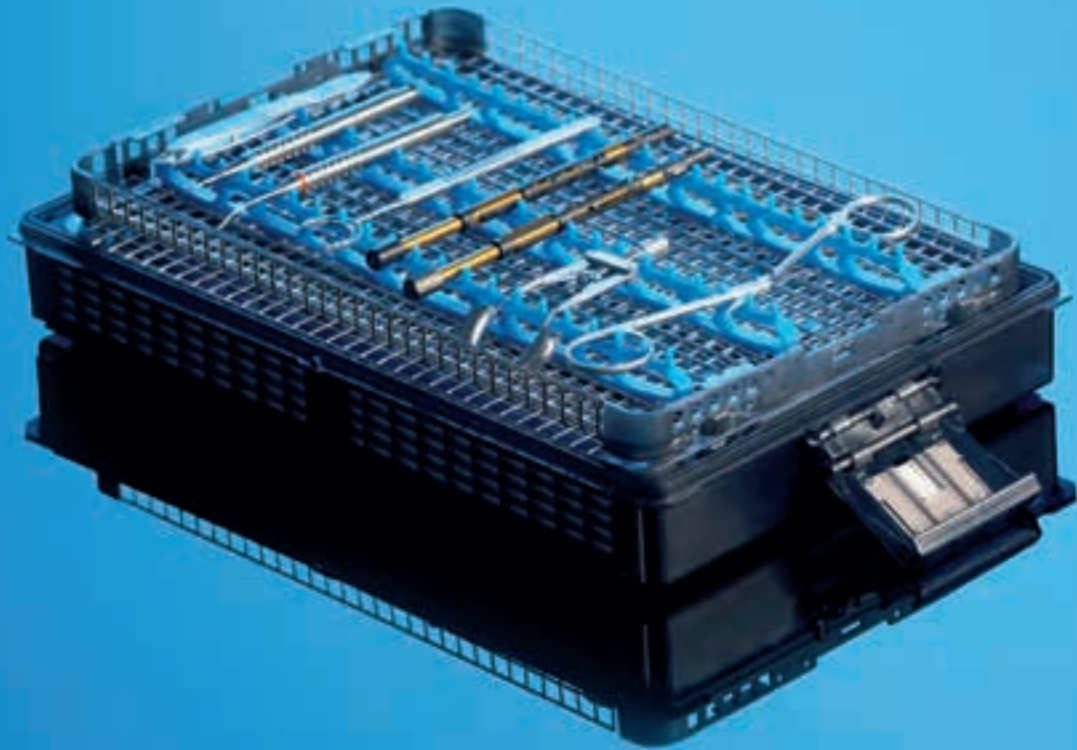

**Geuder**<sup>®</sup>  
Precision made in Germany

ECCE - EXTRA CAPSULAR CATARACT EXTRACTION

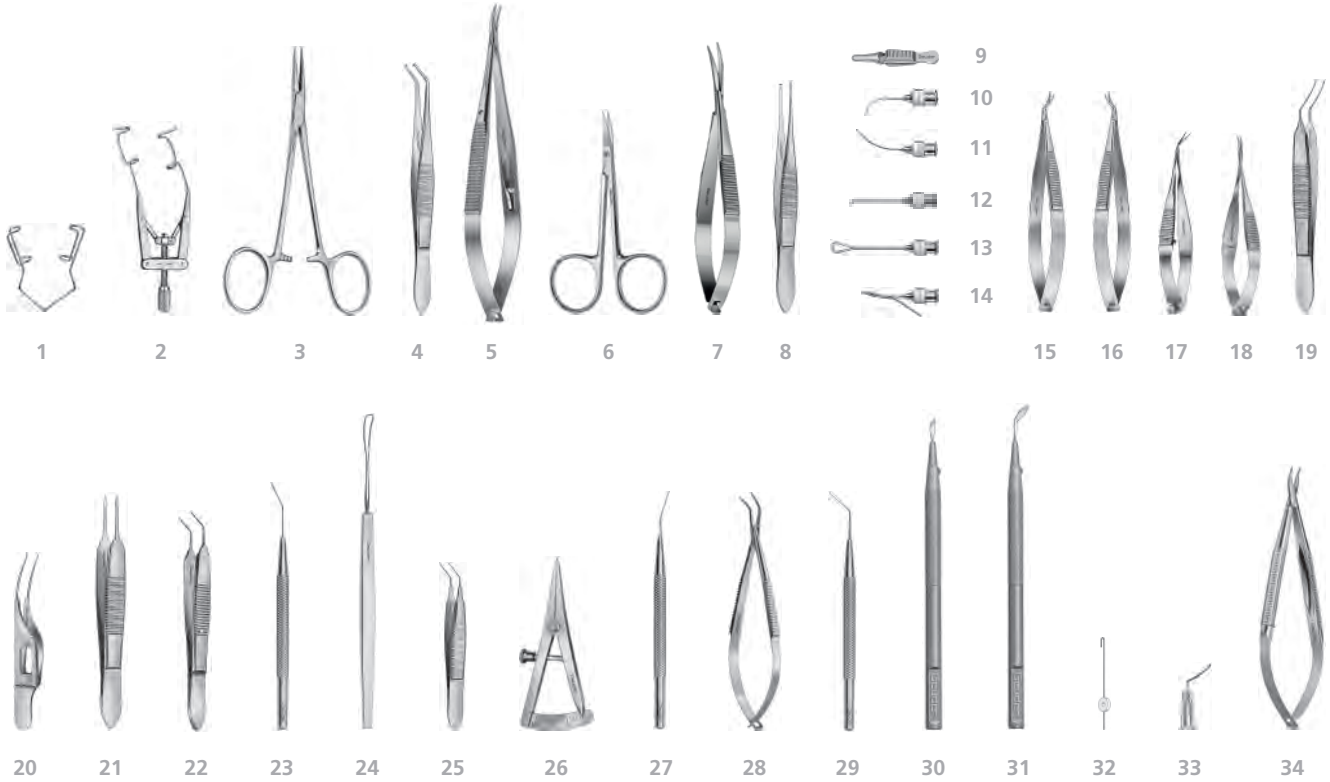

		page			page
1	<b>G-17020</b> <i>BARRAQUER EYE SPECULUM</i> fenestrated.....	15	20	<b>G-18960</b> <i>MICRO COLIBRI FORCEPS</i> with tying platform.....	104
2	<b>G-15960</b> <i>LIEBERMANN-TENNANT EYE SPECULUM</i> .....	25	21	<b>G-19030</b> <i>TUEBINGEN TYING FORCEPS</i> straight.....	106
3	<b>G-18180</b> <i>HALSTEAD MOSQUITO FORCEPS</i> straight.....	135	22	<b>G-19032</b> <i>TYING FORCEPS</i> angled, 7.5 mm.....	107
4	<b>G-18820</b> <i>REMKY SUPERIOR RECTUS FORCEPS</i> .....	125	23	<b>G-16189</b> <i>SPATULA</i> angled, 0.5 mm wide.....	159
5	<b>G-17575</b> <i>CASTROVIEJO NEEDLE HOLDER</i> curved, w. lock.....	142	24	<b>G-15620</b> <i>ARLT LENS LOOP</i> serrated.....	161
6	<b>G-19400</b> <i>BONN EYE SCISSORS</i> curved, delicate.....	92	25	<b>G-18910</b> <i>BONN IRIS FORCEPS</i> angled, 8.0 mm, 1 x 2 teeth.....	110
7	<b>G-19750</b> <i>WESTCOTT SCISSORS</i> blunt tips, curved, 12 cm.....	89	26	<b>G-19130</b> <i>CASTROVIEJO CALIPER</i> 15 mm.....	43
8	<b>G-18791</b> <i>DRESSING FORCEPS</i> 1 x 2 teeth, 0.7 mm.....	110	27	<b>G-16175</b> <i>DARDENNE IRIS HOOK</i> push-pull.....	157
9	<b>G-18190</b> <i>DIEFFENBACH SERREFINE</i> straight, 35 mm.....	136	28	<b>G-18935</b> <i>DODEN IMPLANTATION FORCEPS</i> .....	121
10	<b>G-15185</b> <i>FRANKFURT HYDRODISSECTION CANNULA</i> 27G.....	192	29	<b>G-16167</b> <i>SINSKEY LENS MANIPULATION HOOK</i> 0.2 mm.....	156
11	<b>G-15250</b> <i>SAUTTER HYDRODIS. CANNULA</i> 27G, vert flat.....	192	30	<b>G-34026</b> <i>NANOEDGE PARACENTESIS KNIFE</i> 15° straight.....	217
12	<b>G-16125</b> <i>KRATZ CAPSULE POLISHING CANNULA</i> .....	195	31	<b>G-34146</b> <i>NANOEDGE IMPLANT KNIFE</i> angled, 6 mm.....	217
13	<b>G-16115</b> <i>IRRIGATION VECTIS CANNULA</i> .....	193	32	<b>G-34523</b> <i>SINGLE-USE IRIS RETRACTOR</i> flexible, 2 x 4 pcs.....	223
14	<b>G-16106</b> <i>SIMCOE I/A CANNULA</i> 23G, dual shaft.....	194	33	<b>G-34225</b> <i>SINGLE-USE CYSTOTOME CANNULA</i> .....	224
15	<b>G-19710</b> <i>TROUTMAN CORNEAL SCISSORS</i> right, curved.....	81	34	<b>G-17500</b> <i>BARRAQUER NEEDLE HOLDER</i> curved, w/o lock.....	139
16	<b>G-19715</b> <i>TROUTMAN CORNEAL SCISSORS</i> left, curved.....	81	35	<b>G-39786</b> <i>MICROSTOP® TRAY MINI</i> low, with lid.....	249
17	<b>G-19776</b> <i>CAPSULOTOMY SCISSORS</i> angled up.....	83	36	<b>G-39783</b> <i>MICROSTOP® TRAY MINI</i> low, without lid.....	249
18	<b>G-19765</b> <i>VANNAS CAPSULOTOMY SCISSORS</i> curved.....	84	37	<b>G-39782</b> <i>MICROSTOP® RETAINER ELEMENT</i> low.....	250
19	<b>G-31305</b> <i>CAPSULORHEXIS FORCEPS</i> extra delicate.....	114	38	<b>G-39750</b> <i>MICROSTOP® CONTAINER HIGH</i> for two trays.....	249

ECCE - EXTRA CAPSULAR CATARACT EXTRACTION

PHACO / CATARACT



	page		page
1	G-15960	LIEBERMANN-TENNANT EYE SPECULUM.....	25
2	G-32148	BARRAQUER EYE SPECULUM fenestrated.....	16
3	G-34210	ATKINSON SINGLE-USE RETROBULBAR CANNULA.....	224
4	G-15250	SAUTTER HYDRODIS. CANNULA 27G, vert flat.....	192
5	G-15151	LACRIMAL CANNULA conical, short angle, steel.....	189
6	G-15200	CRANZ EYE DOUCHE silver.....	191
7	G-19023	CASTROVIEJO SUTURING FORCEPS new, 0.3 mm.....	103
8	G-33758	CLEAR-CORNEA-INCISION FIXATION RING.....	150
9	G-19485	STEVENS TENOTOMY SCISSORS curved, long.....	89
10	G-34026	NANOEDGE PHACO SLIT KNIFE 15° straight.....	217
11	G-34055	NANOEDGE PHACO SLIT KNIFE angled, 2.85 mm.....	217
12	G-34051	NANOEDGE PHACO SLIT KNIFE angled, 2.2 mm.....	217
13	G-34052	NANOEDGE PHACO SLIT KNIFE angled, 2.4 mm.....	217
14	G-18960	MICRO COLIBRI FORCEPS with tying platform.....	104
15	G-32162	THOMAS NEUHANN IRIS HOOK (Push-Pull) and NUCLEUS DIVIDING HOOK.....	154
16	G-19765	VANNAS CAPSULOTOMY SCISSORS curved.....	84
17	G-16189	SPATULA angled, 0.5 mm wide.....	159
18	G-32926	AUFFARTH MICS DOUBLE CROSS ACTION CAPSULORHEXIS FORCEPS flat handle.....	115
19	G-31305	CAPSULORHEXIS FORCEPS extra delicate.....	114
20	G-31720	AKAHOSHI PRECHOPPER for micro-incisions.....	120
21	G-31507	NAGAHARA NUCLEUS DIVIDING HOOK.....	152
22	G-16167	SINSKEY LENS MANIPULATION HOOK 0.2 mm.....	156
23	G-19030	TUEBINGEN TYING FORCEPS straight.....	106
24	G-19032	TYING FORCEPS angled, 7.5 mm.....	107
25	G-17500	BARRAQUER NEEDLE HOLDER curved, w/o lock.....	139
26	G-19130	CASTROVIEJO CALIPER 15 mm.....	43
27	G-31901	HOLDING FORCEPS for foldable IOLs.....	124
28	G-19400	BONN EYE SCISSORS curved, delicate.....	92
29	G-22100	KOCH-KOHNEN ASPIRATION HANDPIECE 22G.....	198
30	G-22101	KOCH-KOHNEN IRRIGATION HANDPIECE 22G.....	199
31	G-39786	MICROSTOP <sup>®</sup> TRAY MINI low, with lid.....	249
32	G-39783	MICROSTOP <sup>®</sup> TRAY MINI low, without lid.....	249
33	G-39782	MICROSTOP <sup>®</sup> RETAINER ELEMENT low.....	250
34	G-39750	MICROSTOP <sup>®</sup> CONTAINER HIGH for two trays.....	249

PHACO EMERGENCY

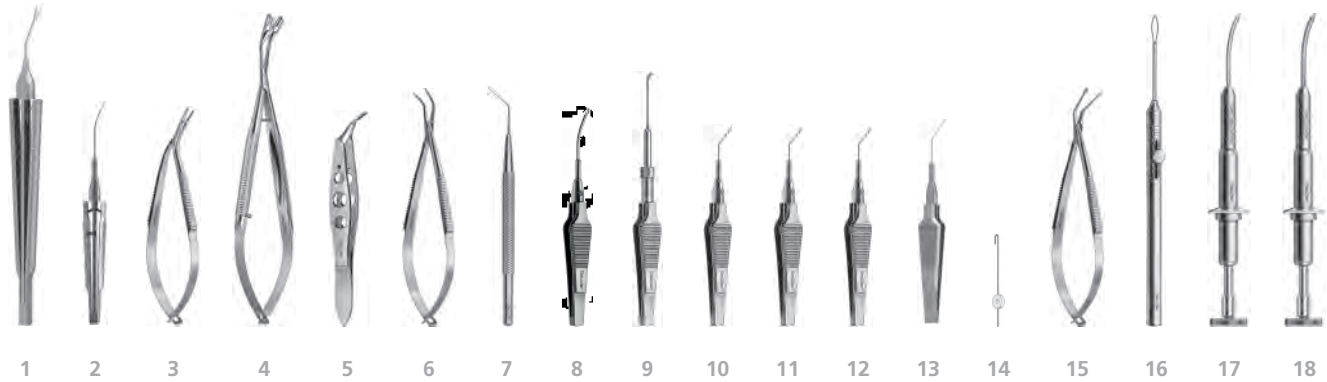

	page		page
1 <b>G-32996</b> SNYDER-OSHER IOL SCISSORS 18G/1.2mm, long.....	88	11 <b>G-32947</b> HATTENBACH HYBRID TYING FORCEPS 25G.....	108
2 <b>G-32997</b> SNYDER-OSHER IOL FORCEPS 22G / 0.7 mm.....	125	12 <b>G-32948</b> HATTENBACH HYBRID SCISSORS 25G.....	86
3 <b>G-32945</b> STEINMETZ IOL SCISSORS.....	87	13 <b>G-32949</b> HATTENBACH HYBRID NEEDLE HOLDER angled.....	143
4 <b>G-31994</b> H.-R. KOCH PREFOLDER for foldable IOLs.....	124	14 <b>G-34523</b> SINGLE-USE IRIS RETRACTOR flexible, 2 x 4 pcs.....	223
5 <b>G-31905</b> H.-R. KOCH FOLDER for 3-piece IOLs.....	124	15 <b>G-32823</b> EXPLANTATION FORCEPS for soft IOLs.....	125
6 <b>G-18935</b> DODEN IMPLANTATION FORCEPS.....	121	16 <b>G-32800</b> H.-R. KOCH SILICONE LENS BI-SECTOR.....	88
7 <b>G-16167</b> SINSKEY LENS MANIPULATION HOOK 0.2 mm.....	156	17 <b>G-32960</b> INJECTOR for MORCHER capsule tension ring.....	241
8 <b>G-32935</b> H.-R. KOCH CAPSULE FORCEPS shaft 22G.....	115	18 <b>G-32970</b> INJECTOR for MORCHER pupil dilator.....	241
9 <b>G-32940</b> H.-R. KOCH CAPSULE SCISSORS 45° angled.....	85	19 <b>G-39526</b> STERISAFE DURO A4 PLUS COMPLETE SET.....	259
10 <b>G-32944</b> HATTENBACH CAPSULORHEXIS FORCEPS angled.....	117		

MSICS - MANUAL SMALL INCISION CATARACT SURGERY

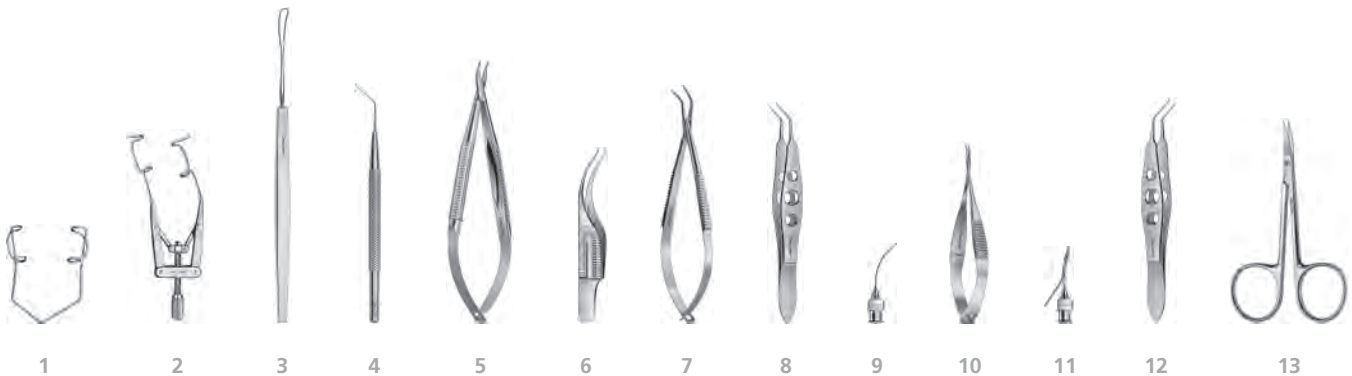

	page		page
1 <b>G-32136</b> BARRAQUER EYE SPECULUM fenest., round.....	16	8 <b>G-31622</b> GASKIN FRAGMENT FORCEPS angled, 9.0 mm.....	108
2 <b>G-15960</b> LIEBERMANN-TENNANT EYE SPECULUM.....	25	9 <b>G-15250</b> SAUTTER HYDRODIS. CANNULA 27G, vert flat.....	192
3 <b>G-15620</b> ARLT LENS LOOP serrated, 3.5 mm wide.....	161	10 <b>G-19765</b> VANNAS CAPSULOTOMY SCISSORS curved.....	84
4 <b>G-16167</b> SINSKEY LENS MANIPULATION HOOK 0.2 mm.....	156	11 <b>G-16106</b> SIMCOE I/A CANNULA 23G, dual shaft.....	194
5 <b>G-17500</b> BARRAQUER NEEDLE HOLDER curved, w/o lock.....	139	12 <b>G-31307</b> CAPSULORHEXIS FORCEPS strong.....	113
6 <b>G-18950</b> COLIBRI FORCEPS with tying platform.....	104	13 <b>G-19400</b> BONN EYE SCISSORS curved, delicate.....	92
7 <b>G-18935</b> DODEN IMPLANTATION FORCEPS.....	121		

MICS - MICRO INCISION CATARACT SURGERY



1 2 3 4 5 6 7 8 9

	page		page
1 <b>G-38448 DIACLEAN CCI DIAMOND KNIFE</b> trapez. 1.5/2.0.....	60	6 <b>G-32012 IRRIGATION HANDPIECE</b> 2x0.5 mm, con., text., 21G.....	200
2 <b>G-32926 AUFFARTH MICS CAPSULORHEXIS FORCEPS</b> .....	115	7 <b>G-32011 ASPIRATION HANDPIECE</b> 0.3 mm port, 21G.....	200
3 <b>G-38240 JAPAN HANDLE</b> for capsule forceps and scissors.....	116	8 <b>G-31507 NAGAHARA NUCLEUS DIVIDING HOOK</b> .....	152
4 <b>G-38244 IKEDA CAPSULORHEXIS FORCEPS</b> 23G, micro-tips	116	9 <b>G-32505 TH. NEUHANN NUCLEUS DIVIDING HOOK</b> .....	151
5 <b>G-38246 YAE CAPSULE SCISSORS</b> 23G, interchangeable.....	85		

FLACS - FEMTOSECOND LASER-ASSISTED CATARACT SURGERY



1 2 3 4 5 6 7 8 9

	page		page
1 <b>G-33965 DICK FEMTOCATARACT EYE SPECULUM</b> .....	26	6 <b>G-15250 SAUTTER HYDRODIS. CANNULA</b> 27G, vert flat.....	192
2 <b>G-33966 DICK FEMTOCATARACT SPATULA</b> double ended....	169	7 <b>G-34245 SAUTTER SINGLE-USE HYDRODISSECTION</b>	
3 <b>G-33967 BREYER FEMTOCATARACT SPATULA</b> blunt tip.....	169	<b>CANNULA</b> .....	225
4 <b>G-33968 HOFFMANN FEMTOCATARACT NUCLEUS</b>		8 <b>G-22100 KOCH-KOHNEN ASPIRATION HANDPIECE</b> 22G.....	198
<b>ROTATOR AND CHOPPER</b> .....	169	9 <b>G-22101 KOCH-KOHNEN IRRIGATION HANDPIECE</b> 22G.....	199
5 <b>G-32926 AUFFARTH MICS CAPSULORHEXIS FORCEPS</b> .....	115	10 <b>G-39526 STERISAFE DURO A4 PLUS COMPLETE SET</b> .....	259

**SNYDER-OSHER  
IOL EXPLANTATION**



1 2

	page
1 <b>G-32997</b> SNYDER-OSHER IOL FORCEPS 22G / 0.7 mm.....	125
2 <b>G-32998</b> SNYDER-OSHER IOL SCISSORS 18G/1.2mm, short.....	88

**TORIC IOL**



1 2 3 4 5 6 7

	page
1 <b>G-33777</b> TOMARK ADJUSTABLE CORNEAL MARKER.....	47
2 <b>G-33776</b> TOMARK PENDULUM INSTRUMENT handheld.....	47
3 <b>G-33774</b> SCOTT CORNEAL PENDULUM MARKER.....	46
4 <b>G-33763</b> GERTEN HORIZONTAL AXIS MARKER.....	46
5 <b>G-16130</b> CAPSULE POLISHING CANNULA 18G / 1.2 mm.....	195
6 <b>G-32564</b> RENTSCH CAPSULE POLISHING CURETTE 90°.....	160
7 <b>G-33786</b> MARKING PEN gentian violet, 20 pcs./box.....	231

**HATTENBACH IRIS SUTURE**



1 2 3

	page
1 <b>G-32949</b> HATTENBACH HYBRID NEEDLE HOLDER angled.....	143
2 <b>G-32947</b> HATTENBACH HYBRID TYING FORCEPS 25G.....	108
3 <b>G-32948</b> HATTENBACH HYBRID SCISSORS 25G.....	86

SNYDER-OSHER IOL EXPLANTATION · TORIC IOL · HATTENBACH IRIS SUTURE



## LASEK - LASER-ASSISTED EPITHELIAL KERATOMILEUSIS



	page		page
1 <b>G-15961</b> <i>LIEBERMANN-TENNANT ASPIRATION SPECULUM</i> .....	28	5 <b>G-33657</b> <i>LOHMANN LASEK FUNNEL 9.5 mm, w crosshairs</i> .....	243
2 <b>G-33650</b> <i>LASEK TREPHINE 8.0 mm, with crosshairs</i> .....	243	6 <b>G-33670</b> <i>LOHMANN LASEK EPI PEELER</i> .....	167
3 <b>G-33652</b> <i>LASEK TREPHINE 9.0 mm, with crosshairs</i> .....	243	7 <b>G-33930</b> <i>TH. NEUHANN LASIK SPATULA</i> .....	167
4 <b>G-33655</b> <i>LOHMANN LASEK FUNNEL 8.5 mm, w crosshairs</i> .....	243	8 <b>G-15180</b> <i>IRRIGATION CANNULA bulbous tip, 26G</i> .....	194

## LASIK - LASER-ASSISTED IN SITU KERATOMILEUSIS



	page		page
1 <b>G-33920</b> <i>KNORZ LASIK EYE SPECULUM w aspiration</i> .....	26	10 <b>G-18914</b> <i>BURATTO LASIK FLAP FORCEPS</i> .....	119
2 <b>G-15960</b> <i>LIEBERMANN-TENNANT EYE SPECULUM</i> .....	25	11 <b>G-33943</b> <i>PFAEFFL FLAP LIFTER V-shaped lifter and hook</i> .....	171
3 <b>G-33745</b> <i>MENDEZ LASIK CORNEAL MARKER</i> .....	46	12 <b>G-33912</b> <i>ZIRM LASIK CORNEAL PROTECTOR</i> .....	167
4 <b>G-33746</b> <i>CHAYET LASIK CORNEAL MARKER</i> .....	46	13 <b>G-33940</b> <i>BLUM FEMTO-LASIK ROUND SPOON bevel up</i> .....	170
5 <b>G-33747</b> <i>LU LASIK CORNEAL MARKER</i> .....	45	14 <b>G-33759</b> <i>FINE-THORNTON FIXATION RING 13 mm, blunt</i> .....	150
6 <b>G-33910</b> <i>ZIRM LASIK DISSECTOR CANNULA 25G, flat</i> .....	197	15 <b>G-33786</b> <i>MARKING PEN gentian violet, 20 pcs./box</i> .....	231
7 <b>G-33911</b> <i>ZIRM LASIK IRRIGATION CANNULA 20G, flat</i> .....	197	16 <b>G-18150</b> <i>HOLDER FOR ABSORBENT STRIPS</i> .....	145
8 <b>G-33909</b> <i>BAUER LASIK CANNULA double-armed, 25G</i> .....	196	17 <b>G-18127</b> <i>ABSORBENT SWABS 17 mm, sterile</i> .....	231
9 <b>G-33428</b> <i>PFAEFFL FLAPORHEXIS FORCEPS oval tips</i> .....	118	18 <b>G-39526</b> <i>STERISAFE DURO A4 PLUS COMPLETE SET</i> .....	259

FEMTO LASIK

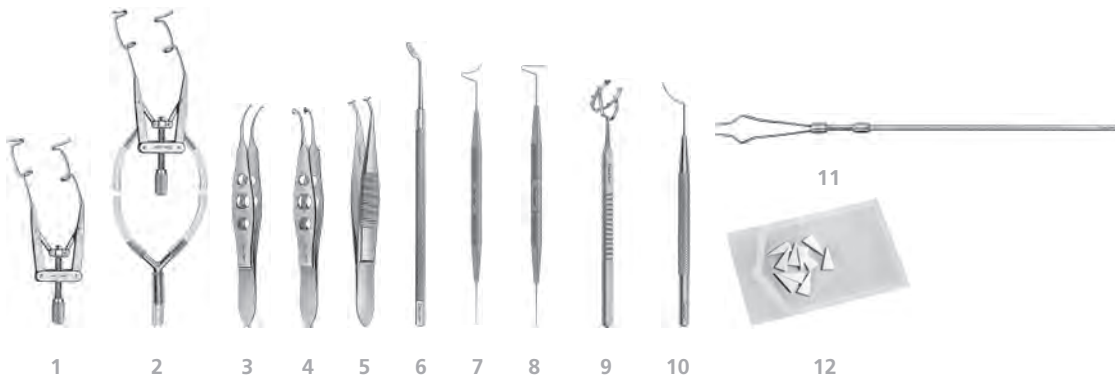

1	<b>G-15960</b>	<b>LIEBERMANN-TENNANT EYE SPECULUM</b> .....	25	7	<b>G-33427</b>	<b>PFAEFFL FLAP LIFTER</b> curved lifter and hook.....	171
2	<b>G-15961</b>	<b>LIEBERMANN-TENNANT ASPIRATION SPECULUM</b> .....	28	8	<b>G-33943</b>	<b>PFAEFFL FLAP LIFTER</b> V-shaped lifter and hook.....	171
3	<b>G-18914</b>	<b>BURATTO LASIK FLAP FORCEPS</b> .....	119	9	<b>G-33758</b>	<b>CLEAR-CORNEA-INCISION FIXATION RING</b> .....	150
4	<b>G-33428</b>	<b>PFAEFFL FLAPORHEXIS FORCEPS</b> oval tips.....	118	10	<b>G-33930</b>	<b>TH. NEUHANN LASIK SPATULA</b> .....	167
5	<b>G-33429</b>	<b>KNORZ FEMTO-LASIK FLAP FORCEPS</b> T-bar tips.....	118	11	<b>G-18150</b>	<b>HOLDER FOR ABSORBENT STRIPS</b> .....	145
6	<b>G-33912</b>	<b>ZIRM LASIK CORNEAL PROTECTOR</b> .....	167	12	<b>G-18127</b>	<b>ABSORBENT SWABS</b> 17 mm, sterile.....	231

RELEX® SMILE - SMALL INCISION LENTICULE EXTRACTION

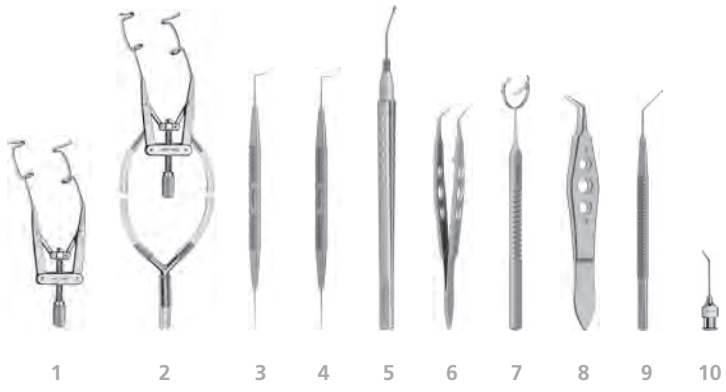

			page				page
1	<b>G-15960</b>	<b>LIEBERMANN-TENNANT EYE SPECULUM</b> .....	25	5	<b>G-33960</b>	<b>RUPAL SHAH LENTICULE MICRO FORCEPS</b> .....	119
2	<b>G-15961</b>	<b>LIEBERMANN-TENNANT ASPIRATION SPECULUM</b> .....	28	6	<b>G-33961</b>	<b>LENTICULE FORCEPS</b> angled to side, 7.5 mm.....	119
3	<b>G-33952</b>	<b>CHANSUE FEMTO DOUBLE INSTRUMENT</b> spatula/hook.....	170	7	<b>G-33759</b>	<b>FINE-THORNTON FIXATION RING</b> 13 mm, blunt.....	150
4	<b>G-33950</b>	<b>CHANSUE FEMTO DOUBLE INSTRUMENT</b> spoon-spatula/hook.....	169	8	<b>G-33941</b>	<b>KELMAN-MCPHERSON FRAGMENT FORCEPS</b> .....	108
				9	<b>G-33959</b>	<b>BREYER FEMTO-LASIK HOOK</b> .....	171
				10	<b>G-33910</b>	<b>ZIRM LASIK DISSECTOR CANNULA</b> 25G, flat.....	197

\*ReLex® (Refractive Lenticule Extraction) is a registered trademark of Carl ZeissMeditec AG.

FEMTO LASIK · RELEX SMILE

KERATOPLASTY

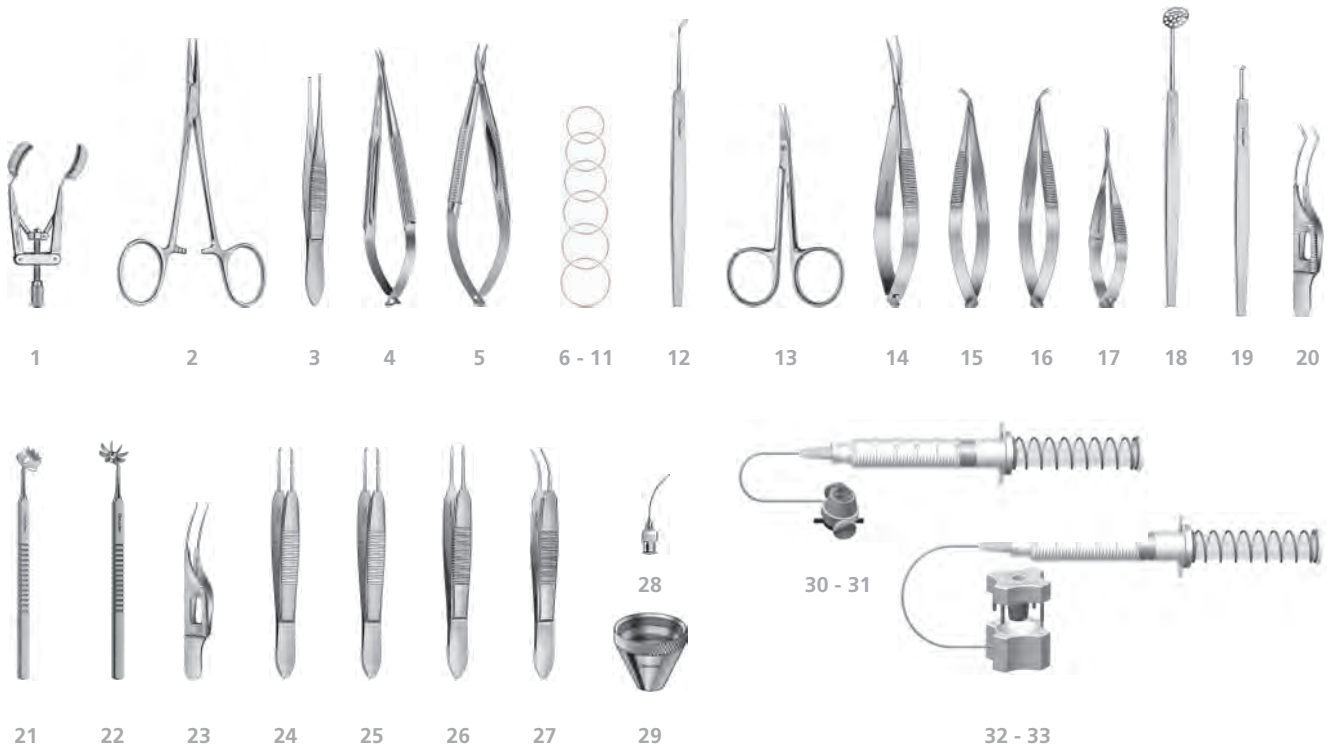

	page		page
1 <b>G-15966</b> <i>KERSHNER EYE SPECULUM</i> solid blades.....	25	18 <b>G-15758</b> <i>KERATOPLASTY SPATULA</i> perforated.....	163
2 <b>G-18180</b> <i>HALSTEAD MOSQUITO FORCEPS</i> straight.....	135	19 <b>G-14200</b> <i>PAUFIQUE KERATOPLASTY KNIFE</i> .....	64
3 <b>G-18791</b> <i>DRESSING FORCEPS</i> 1 x 2 teeth, 0.7 mm.....	110	20 <b>G-18972</b> <i>THOMAS NEUHANN KERATOPLASTY FORCEPS</i> .....	104
4 <b>G-17450</b> <i>JACOBI NEEDLE HOLDER</i> curved, w/o lock.....	139	21 <b>G-32229</b> <i>DUNCKER SUTURE MARKER</i> for 8.0 mm transplant...42	
5 <b>G-17500</b> <i>BARRAQUER NEEDLE HOLDER</i> curved, w/o lock.....	139	22 <b>G-33727</b> <i>THOMAS NEUHANN CORNEAL MARKER</i> 8 blades...41	
6 <b>G-15065</b> <i>FLIERINGA FIXATION RING</i> 15 mm.....	150	23 <b>G-18960</b> <i>MICRO COLIBRI FORCEPS</i> with tying platform.....	104
7 <b>G-15070</b> <i>FLIERINGA FIXATION RING</i> 16 mm.....	150	24 <b>G-19001</b> <i>CASTROVIEJO SUTURING FORCEPS</i> 0.12 mm.....	103
8 <b>G-15075</b> <i>FLIERINGA FIXATION RING</i> 17 mm.....	150	25 <b>G-19010</b> <i>CASTROVIEJO SUTURING FORCEPS</i> 0.6 mm.....	103
9 <b>G-15080</b> <i>FLIERINGA FIXATION RING</i> 18 mm.....	150	26 <b>G-19030</b> <i>TUEBINGEN TYING FORCEPS</i> straight.....	106
10 <b>G-15085</b> <i>FLIERINGA FIXATION RING</i> 19 mm.....	150	27 <b>G-19040</b> <i>TUEBINGEN TYING FORCEPS</i> curved.....	106
11 <b>G-15090</b> <i>FLIERINGA FIXATION RING</i> 20 mm.....	150	28 <b>G-15250</b> <i>SAUTTER HYDRODIS. CANNULA</i> 27G, vert flat.....	192
12 <b>G-14020</b> <i>KUHNT CORNEAL SCARIFIER</i> fig. 2.....	64	29 <b>G-32318</b> <i>MALONEY KERATOMETER</i> .....	45
13 <b>G-19400</b> <i>BONN EYE SCISSORS</i> curved, delicate.....	92	30 <b>G-570750</b> <i>NANOEDGE VACUUM TREPHINE</i> 7.5 mm.....	216
14 <b>G-19750</b> <i>WESTCOTT SCISSORS</i> blunt tips, curved, 12 cm.....	89	31 <b>G-570800</b> <i>NANOEDGE VACUUM TREPHINE</i> 8.0 mm.....	216
15 <b>G-19720</b> <i>KATZIN KERATOPLASTY SCISSORS</i> right, 10 cm.....	81	32 <b>G-560800</b> <i>NANOEDGE VACUUM CORNEAL PUNCH</i> 8.0 mm...216	
16 <b>G-19725</b> <i>KATZIN KERATOPLASTY SCISSORS</i> left, 10 cm.....	81	33 <b>G-560850</b> <i>NANOEDGE VACUUM CORNEAL PUNCH</i> 8.5 mm...216	
17 <b>G-19765</b> <i>VANNAS CAPSULOTOMY SCISSORS</i> curved.....	84		

## DSEK / DSAEK - DESCEMET'S STRIPPING (AUTOMATED) ENDOTHELIAL KERATOPLASTY



	page		page
1 <b>G-15960</b> <i>LIEBERMANN-TENNANT EYE SPECULUM</i> .....	25	7 <b>G-38602</b> <i>NEUHANN IRRIGATION DESCEMET SCRAPER</i> .....	202
2 <b>G-33416</b> <i>BOPP A.C. INFUSION CANNULA</i> silicone tube.....	191	8 <b>G-38634</b> <i>GERTEN DSAEK/DMEK RHEXIS FORCEPS</i> 23G.....	117
3 <b>G-38600</b> <i>NEUHANN CORNEAL MARKER</i> double 8 / 9 mm.....	41	9 <b>G-38603</b> <i>DSAEK IMPLANTATION FORCEPS</i> .....	118
4 <b>G-38607</b> <i>DESCEMET INCISION HOOK</i> 0.2 mm tip.....	168	10 <b>G-38606</b> <i>TH. NEUHANN DSAEK FORCEPS</i> 21G.....	118
5 <b>G-38608</b> <i>DESCEMET SCRAPER</i> .....	168	11 <b>G-38604</b> <i>TH. NEUHANN DSAEK INSERTION SPATULA</i> .....	168
6 <b>G-38601</b> <i>ALTHAUSCARTSBURG IRRIGATION DESCEMET HOOK</i> .....	202		

## DALK - DEEP ANTERIOR LAMELLAR KERATOPLASTY

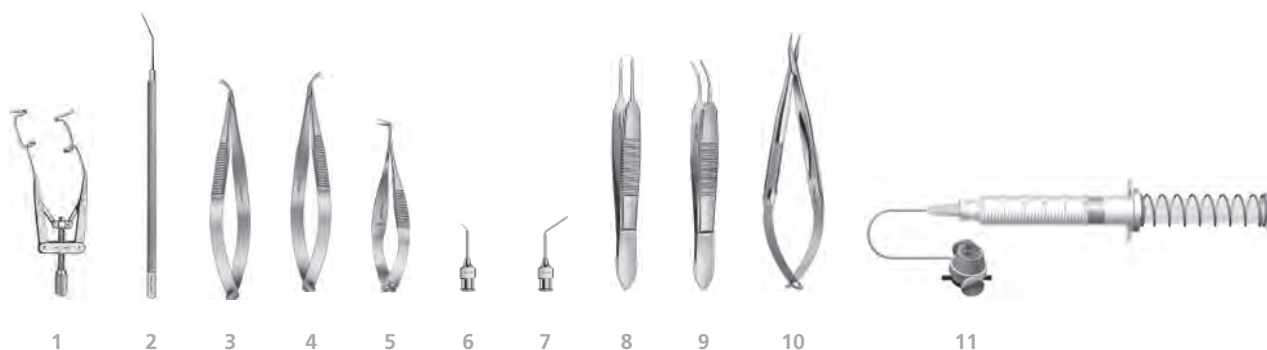

	page		page
1 <b>G-15960</b> <i>LIEBERMANN-TENNANT EYE SPECULUM</i> .....	25	7 <b>G-15312</b> <i>KRUMEICH CORNEAL IRRIGATION CANNULA</i> 23G..	197
2 <b>G-32728</b> <i>RENTSCH SPATULA</i> tapered 0.6 to 0.3 mm.....	159	8 <b>G-19030</b> <i>TUEBINGEN TYING FORCEPS</i> straight.....	106
3 <b>G-19720</b> <i>KATZIN KERATOPLASTY SCISSORS</i> right, 10 cm.....	81	9 <b>G-19040</b> <i>TUEBINGEN TYING FORCEPS</i> curved.....	106
4 <b>G-19725</b> <i>KATZIN KERATOPLASTY SCISSORS</i> left, 10 cm.....	81	10 <b>G-17505</b> <i>BARRAQUER NEEDLE HOLDER</i> curved, w/o lock.....	139
5 <b>G-19770</b> <i>VANNAS CAPSULOTOMY SCISSORS</i> angled to side.....	84	11 <b>G-570800</b> <i>NANOEDGE VACUUM TREPHINE</i> 8.0 mm.....	216
6 <b>G-15310</b> <i>KRUMEICH CORNEAL IRRIGATION CANNULA</i> 27G..	197		

## DMEK - DESCEMET MEMBRANE ENDOTHELIAL KERATOPLASTY

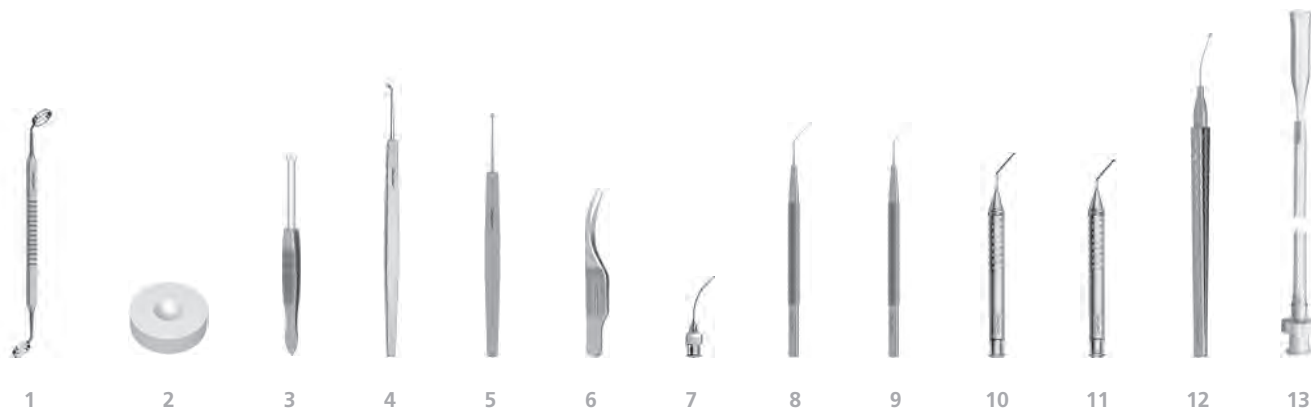

	page		page
1 <b>G-38600</b> NEUHANN CORNEAL MARKER double 8 / 9 mm.....	41	8 <b>G-38607</b> DESCEMET INCISION HOOK 0.2 mm tip.....	168
2 <b>G-38620</b> SZURMAN DMEK GRAFT RETAINER.....	71	9 <b>G-38608</b> DESCEMET SCRAPER.....	168
3 <b>G-38623</b> REMKY DMEK KERATOPLASTY FORCEPS.....	105	10 <b>G-38601</b> ALTHAUS-CARTSBURG IRRIGATION DESCEMET HOOK.....	202
4 <b>G-38621</b> SZURMAN DMEK PREPARATION SCRAPER.....	64	11 <b>G-38602</b> NEUHANN IRRIGATION DESCEMET SCRAPER.....	202
5 <b>G-38622</b> SZURMAN DMEK PREPARATION SPATULA.....	168	12 <b>G-38634</b> GERTEN DSAEK/DMEK RHEXIS FORCEPS 23G.....	117
6 <b>G-38624</b> SZURMAN DMEK PREPARATION FORCEPS.....	117	13 <b>G-38635</b> SZURMAN SINGLE-USE DMEK CARTRIDGE 1.6 mm.....	223
7 <b>G-32167</b> SAUTTER HYDRODIS. CANNULA 27G, horiz flat.....	192		

GLAUCOMA

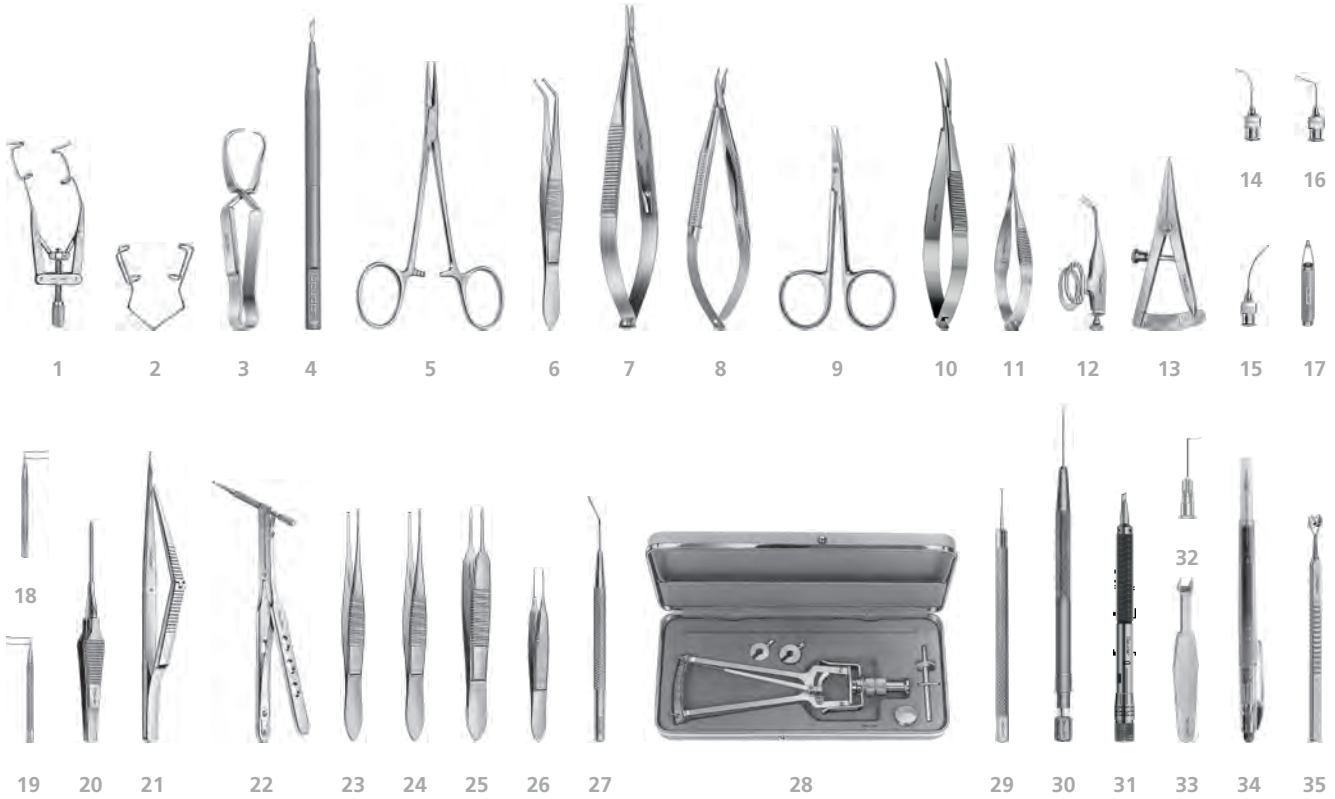

	page		page
1 <b>G-15960</b> <i>LIEBERMANN-TENNANT EYE SPECULUM</i> .....	25	20 <b>G-18235</b> <i>GREHN GLAUCOMA PUNCH 20G</i> .....	76
2 <b>G-17020</b> <i>BARRAQUER EYE SPECULUM</i> fenestrated.....	15	21 <b>G-18238</b> <i>KELLY DESCEMET PUNCH</i> for Glaucoma, 1.0 mm.....	76
3 <b>G-33200</b> <i>SCHAEDEL TOWEL FORCEPS</i> .....	136	22 <b>G-18239</b> <i>LUNTZ-DODICK TRABECULECTOMY PUNCH</i> 360° rotatable.....	76
4 <b>G-34036</b> <i>NANOEDGE PARACENTESIS KNIFE 30°</i> straight.....	217	23 <b>G-18791</b> <i>DRESSING FORCEPS</i> 1 x 2 teeth, 0.7 mm.....	110
5 <b>G-18180</b> <i>HALSTEAD MOSQUITO FORCEPS</i> straight.....	135	24 <b>G-18792</b> <i>DRESSING FORCEPS</i> 1 x 2 teeth, 1.0 mm.....	110
6 <b>G-18820</b> <i>REMKY SUPERIOR RECTUS FORCEPS</i> .....	125	25 <b>G-19030</b> <i>TUEBINGEN TYING FORCEPS</i> straight.....	106
7 <b>G-17565</b> <i>CASTROVIEJO NEEDLE HOLDER</i> straight, w. lock.....	142	26 <b>G-18900</b> <i>BONN IRIS FORCEPS</i> straight, 1 x 2 teeth.....	110
8 <b>G-17500</b> <i>BARRAQUER NEEDLE HOLDER</i> curved, w/o lock.....	139	27 <b>G-16190</b> <i>SPATULA</i> angled, 1.0 mm wide.....	159
9 <b>G-19400</b> <i>BONN EYE SCISSORS</i> curved, delicate.....	92	28 <b>G-19230</b> <i>SCHIOETZ TONOMETER</i> .....	48
10 <b>G-19750</b> <i>WESTCOTT SCISSORS</i> blunt tips, curved, 12 cm.....	89	29 <b>G-14105</b> <i>MICRO ROUND KNIFE</i> for viscocanalostomy.....	63
11 <b>G-19630</b> <i>TUEBINGEN CAPSULOTOMY SCISSORS</i> curved.....	84	30 <b>G-31487</b> <i>DIAMOND KNIFE</i> for viscocanalostomy.....	62
12 <b>G-19680</b> <i>BARRAQUER SCISSORS</i> 7 mm blades.....	87	31 <b>G-31470</b> <i>TRI-FACET DIAMOND STEP KNIFE</i> .....	61
13 <b>G-19130</b> <i>CASTROVIEJO CALIPER</i> 15 mm.....	43	32 <b>G-15197</b> <i>SINGLE-USE IRRIGATION CANNULA</i> angled, 35G.....	226
14 <b>G-15185</b> <i>FRANKFURT HYDRODISSECTION CANNULA</i> 27G.....	192	33 <b>G-32210</b> <i>FRONIMOPOULUS MARKER</i> U-shaped.....	44
15 <b>G-15250</b> <i>SAUTTER HYDRODIS. CANNULA</i> 27G, vert flat.....	192	34 <b>G-33786</b> <i>MARKING PEN</i> gentian violet, 20 pcs./box.....	231
16 <b>G-22619</b> <i>PH. JACOBI TRABECULAR ASPIRATION CANNULA</i> .....	193	35 <b>G-32209</b> <i>TOBIAS NEUHANN SCLERAL FLAP MARKER</i> .....	44
17 <b>G-20612</b> <i>SCHMIDT-MUMM DUCT TREPHINE</i> 1.2 mm.....	69	36 <b>G-39526</b> <i>STERISAFE DURO A4 PLUS COMPLETE SET</i> .....	259
18 <b>G-15125</b> <i>HARMS TRABECULAR PROBE</i> right.....	186		
19 <b>G-15130</b> <i>HARMS TRABECULAR PROBE</i> left.....	186		

EMERGENCY

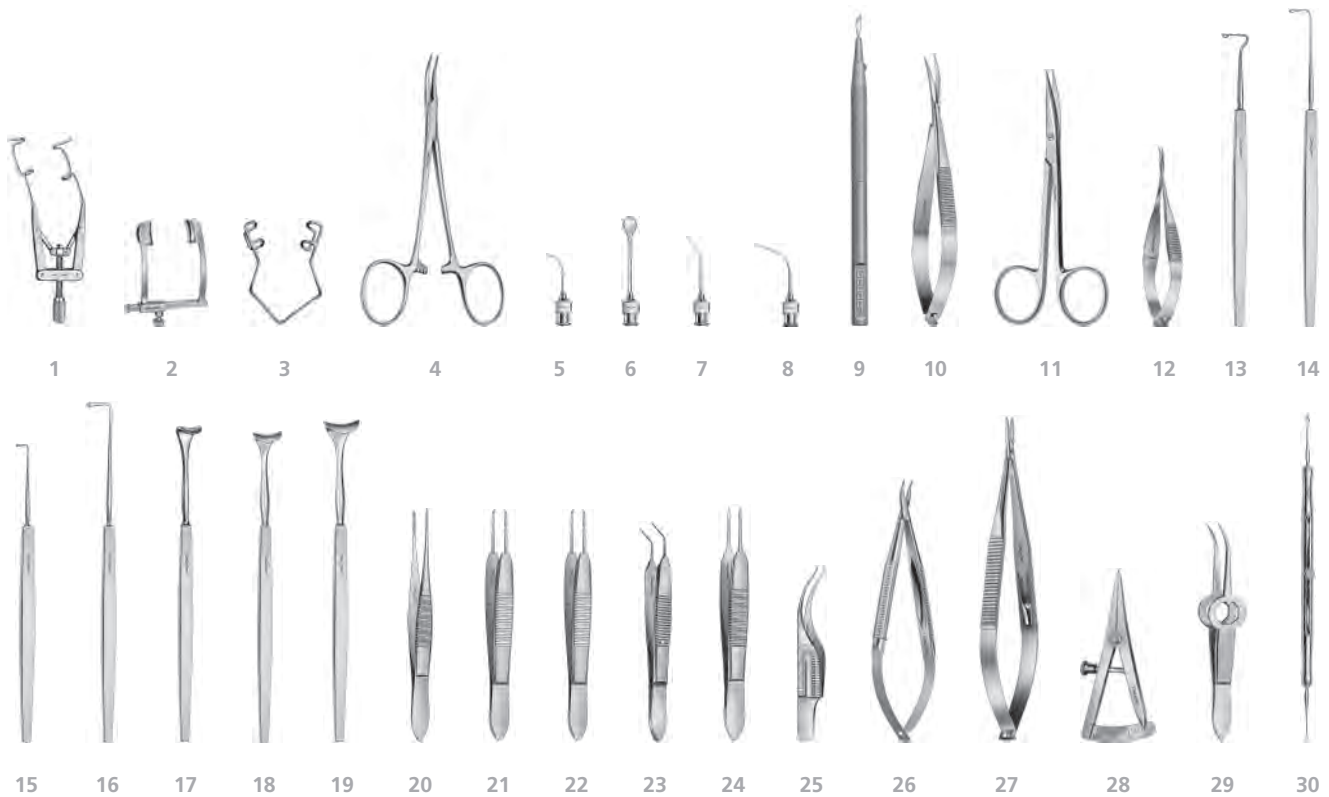

	page		page
1	25	17	35
2	23	18	35
3	15	19	35
4	135	20	110
5	192	21	103
6	191	22	103
7	189	23	107
8	189	24	106
9	217	25	104
10	89	26	139
11	89	27	142
12	84	28	43
13	174	29	101
14	173	30	55
15	173		
16	174		

ENUCLEATION

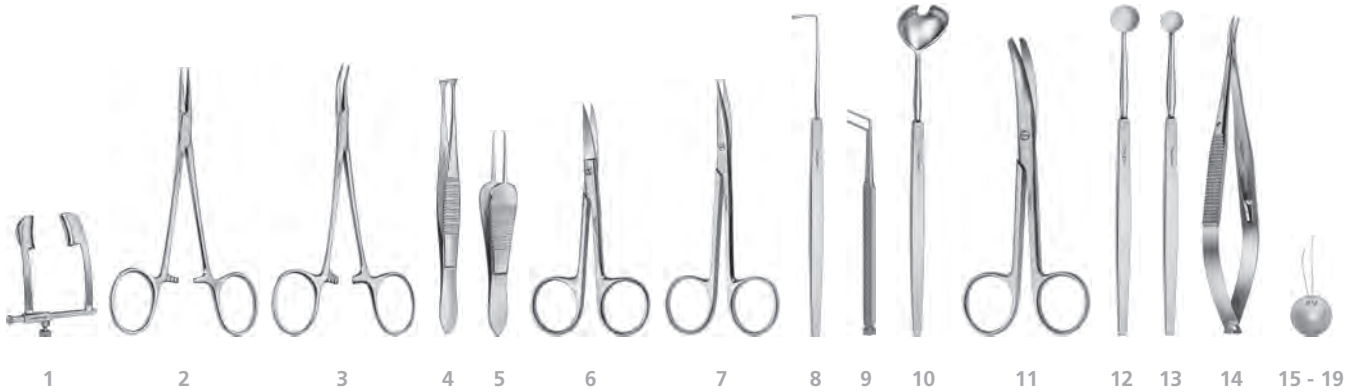

	page		page
1 <b>G-15990</b> COOK EYE SPECULUM large.....	23	11 <b>G-19525</b> ENUCLEATION SCISSORS medium curve, 13.5 cm.....	94
2 <b>G-18180</b> HALSTEAD MOSQUITO FORCEPS straight.....	135	12 <b>G-31545</b> BUNGE EXENTERATION CURETTE medium.....	52
3 <b>G-18181</b> HALSTEAD MOSQUITO FORCEPS curved.....	135	13 <b>G-31555</b> BUNGE EXENTERATION CURETTE large.....	52
4 <b>G-19050</b> GRAEFE FIXATION FORCEPS without lock.....	109	14 <b>G-17575</b> CASTROVIEJO NEEDLE HOLDER curved, w. lock.....	142
5 <b>G-18940</b> PAUFIQUE UNIVERSAL SUTURING FORCEPS.....	105	15 <b>G-20416</b> WALSER EYE SPHERE 16 mm.....	245
6 <b>G-19375</b> EYE SCISSORS curved, sharp tips, 10 cm.....	91	16 <b>G-20417</b> WALSER EYE SPHERE 17 mm.....	245
7 <b>G-19485</b> STEVENS TENOTOMY SCISSORS curved, long.....	89	17 <b>G-20418</b> WALSER EYE SPHERE 18 mm.....	245
8 <b>G-15810</b> GRAEFE STRABISMUS HOOK large, 12 mm.....	173	18 <b>G-20419</b> WALSER EYE SPHERE 19 mm.....	245
9 <b>G-19112</b> BANGERTER MUSCLE FORCEPS.....	126	19 <b>G-20420</b> WALSER EYE SPHERE 20 mm.....	245
10 <b>G-15780</b> WELLS ENUCLEATION SPOON.....	167	20 <b>G-39526</b> STERISAFE DURO A4 PLUS COMPLETE SET.....	259

PTERYGIUM

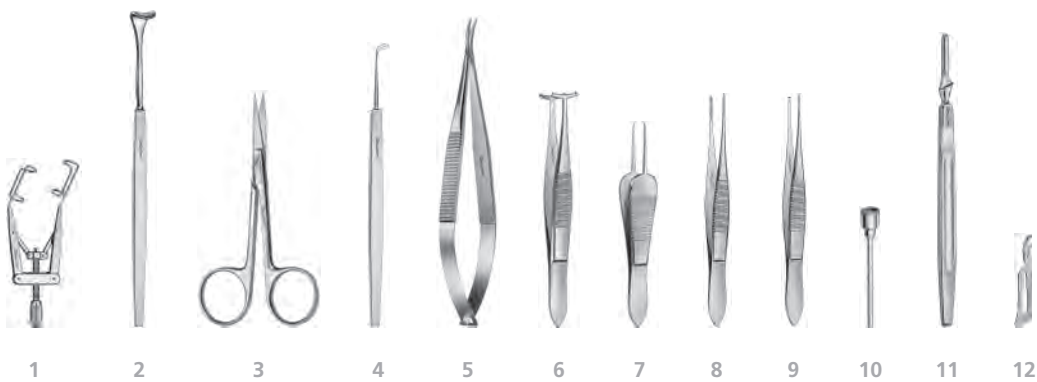

	page		page
1 <b>G-15965</b> KERSHNER EYE SPECULUM fenestrated.....	25	7 <b>G-18940</b> PAUFIQUE UNIVERSAL SUTURING FORCEPS.....	105
2 <b>G-32120</b> DESMARRES LID RETRACTOR fig. 0.....	35	8 <b>G-18782</b> DRESSING FORCEPS serrated, 1.0 mm.....	110
3 <b>G-19355</b> EYE SCISSORS straight, sharp tips, 10 cm.....	91	9 <b>G-18792</b> DRESSING FORCEPS 1 x 2 teeth, 1.0 mm.....	110
4 <b>G-14010</b> KUHN CORNEAL SCARIFIER fig. 1.....	64	10 <b>G-18300</b> DIAMOND BURR 8.0 mm.....	244
5 <b>G-17570</b> CASTROVIEJO NEEDLE HOLDER curved, w/o lock.....	142	11 <b>G-32700</b> SCALPEL HANDLE.....	231
6 <b>G-19080</b> BARRAQUER FIXATION FORCEPS.....	109	12 <b>G-32705</b> SCALPEL SURGICAL BLADES #11, curved, 100 pcs.....	231

ENUCLEATION · PTERYGIUM



OFFICE SET (OPTOMETRIST)



	page		page
1 <b>G-17020</b> <i>BARRAQUER EYE SPECULUM</i> fenestrated.....	15	10 <b>G-19460</b> <i>STRABISMUS SCISSORS</i> short, straight.....	91
2 <b>G-17025</b> <i>BARRAQUER EYE SPECULUM</i> infants, fenestrated.....	15	11 <b>G-32715</b> <i>SCHOCKET SCLERAL DEPRESSOR</i> .....	180
3 <b>G-18975</b> <i>BARRAQUER SUTURE REMOVING FORCEPS</i> .....	104	12 <b>G-15870</b> <i>MEYHOEFFER CHALAZION CURETTE</i> 2 mm.....	51
4 <b>G-19765</b> <i>VANNAS CAPSULOTOMY SCISSORS</i> curved.....	84	13 <b>G-18680</b> <i>LAMBERT CHALAZION FORCEPS</i> .....	134
5 <b>G-18750</b> <i>BARRAQUER CILIA FORCEPS</i> .....	101	14 <b>G-31105</b> <i>EYE SHIELD</i> plastic, transparent, 100 pcs.....	245
6 <b>G-14550</b> <i>FOREIGN BODY INSTRUMENT</i> needle/spud.....	55	15 <b>G-15230</b> <i>BONN IRRIGATION CANNULA</i> delicate.....	194
7 <b>G-18850</b> <i>SHAAF CILIA AND FOREIGN BODY FORCEPS</i> .....	101	16 <b>G-32665</b> <i>SILICONE BULB</i> 20 ml.....	212
8 <b>G-150401</b> <i>WILDER LACRIMAL PROBE</i> slim, long taper.....	183	17 <b>G-32920</b> <i>JAMESON STRABISMUS HOOK</i> 11 mm.....	174
9 <b>G-32120</b> <i>DESMARRES LID RETRACTOR</i> fig. 0.....	35	18 <b>G-39526</b> <i>STERISAFE DURO A4 PLUS COMPLETE SET</i> .....	259

CHALAZION

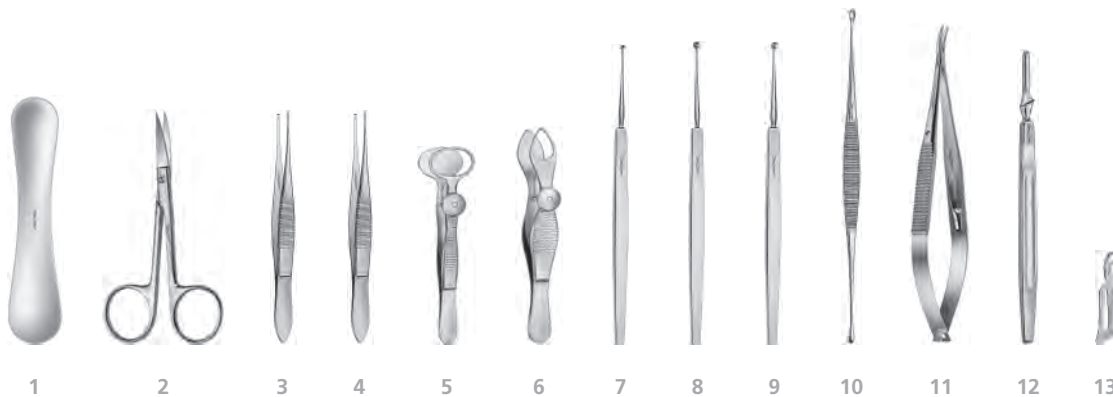

	page		page
1 <b>G-17040</b> <i>JAEGER LID PLATE</i> stainless steel.....	36	8 <b>G-15875</b> <i>MEYHOEFFER CHALAZION CURETTE</i> 2.5 mm.....	51
2 <b>G-19375</b> <i>EYE SCISSORS</i> curved, sharp tips, 10 cm.....	91	9 <b>G-15880</b> <i>MEYHOEFFER CHALAZION CURETTE</i> 3.0 mm.....	51
3 <b>G-18791</b> <i>DRESSING FORCEPS</i> 1 x 2 teeth, 0.7 mm.....	110	10 <b>G-15910</b> <i>AXENFELD CHALAZION CURETTE</i> .....	52
4 <b>G-18792</b> <i>DRESSING FORCEPS</i> 1 x 2 teeth, 1.0 mm.....	110	11 <b>G-17575</b> <i>CASTROVIEJO NEEDLE HOLDER</i> curved, w. lock.....	142
5 <b>G-18685</b> <i>DESMARRES CHALAZION FORCEPS</i> 20 mm.....	134	12 <b>G-32700</b> <i>SCALPEL HANDLE</i> .....	231
6 <b>G-18710</b> <i>LORDAN CHALAZION FORCEPS</i> triangular.....	134	13 <b>G-32705</b> <i>SCALPEL SURGICAL BLADES</i> #11, curved, 100 pcs..	231
7 <b>G-15870</b> <i>MEYHOEFFER CHALAZION CURETTE</i> 2.0 mm.....	51		

LID / PTOSIS

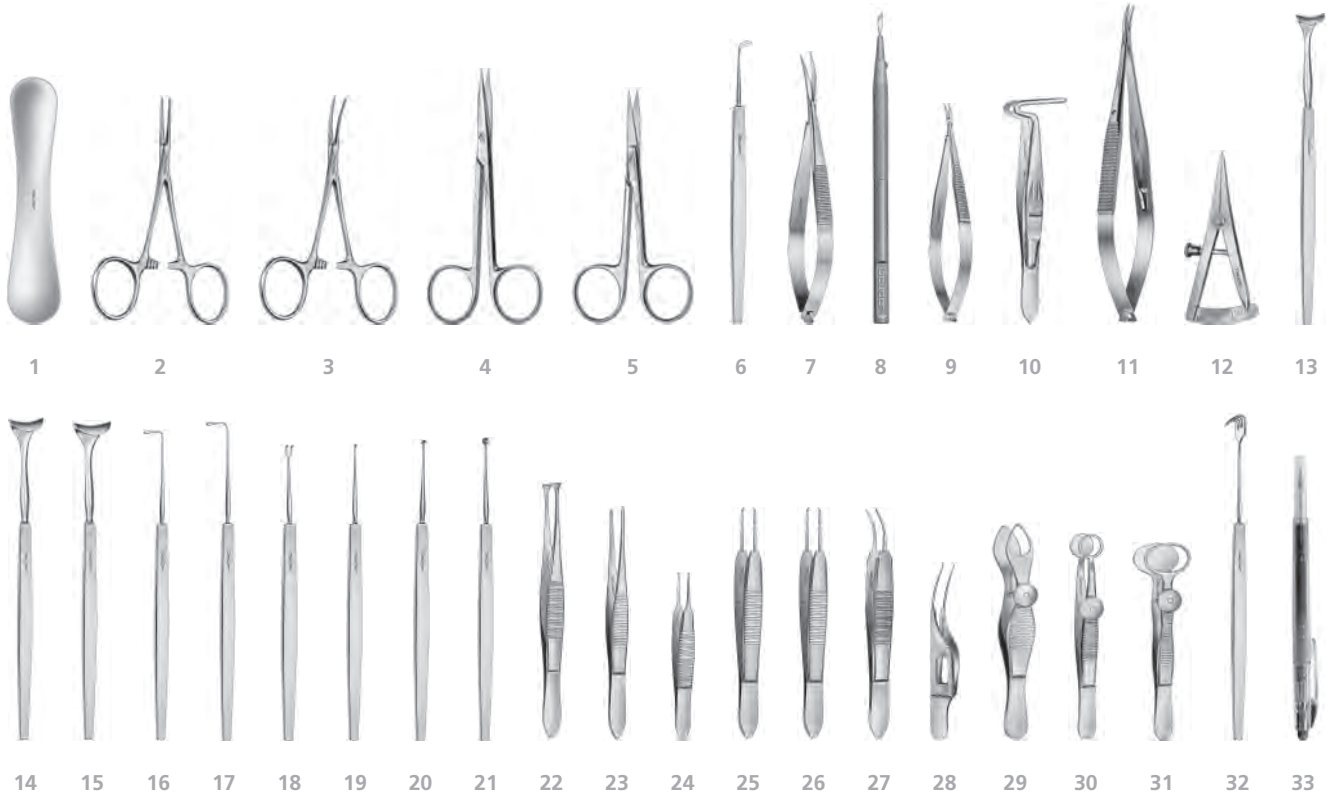

	page		page
1	36	18	36
2	135	19	51
3	135	20	51
4	89	21	51
5	91	22	109
6	64	23	102
7	89	24	111
8	217	25	103
9	82	26	103
10	134	27	106
11	142	28	104
12	43	29	134
13	35	30	134
14	35	31	134
15	36	32	37
16	173	33	231
17	173		

LID / PTOSIS

DCR / LACRIMAL

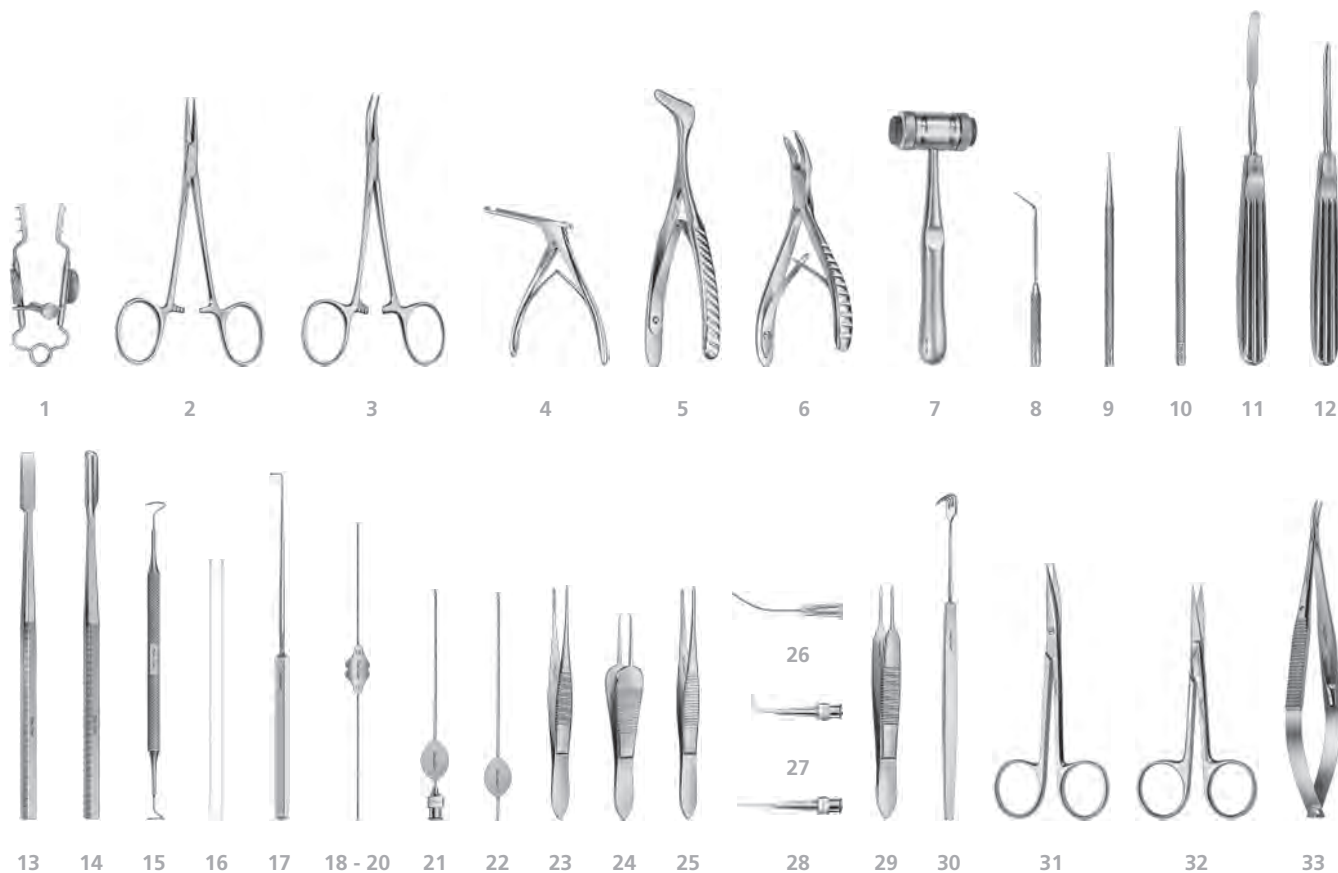

	page		page
1 <b>G-17070</b> <i>MUELLER LACRIMAL SAC RETRACTOR</i> .....	38	18 <b>G-150101</b> <i>BOWMAN LACRIMAL PROBE</i> size 0000/000.....	185
2 <b>G-18180</b> <i>HALSTEAD MOSQUITO FORCEPS</i> straight.....	135	19 <b>G-150102</b> <i>BOWMAN LACRIMAL PROBE</i> size 00/0.....	185
3 <b>G-18181</b> <i>HALSTEAD MOSQUITO FORCEPS</i> curved.....	135	20 <b>G-150103</b> <i>BOWMAN LACRIMAL PROBE</i> size 1/2.....	185
4 <b>G-18225</b> <i>KERRISON BONE NIBBLING RONGEUR</i> .....	75	21 <b>G-33198</b> <i>JUENEMANN LACRIMAL PROBE CANNULA</i> .....	190
5 <b>G-32355</b> <i>NASAL SPECULUM</i> .....	242	22 <b>G-33194</b> <i>JUENEMANN LACRIMAL PROBE</i> 0.8 mm, w grip plate.....	186
6 <b>G-31810</b> <i>FRIEDMANN RONGEUR</i> .....	242	23 <b>G-18782</b> <i>DRESSING FORCEPS</i> serrated, 1.0 mm.....	110
7 <b>G-33125</b> <i>MEAD HAMMER</i> length 19 cm, 300 g.....	242	24 <b>G-18940</b> <i>PAUFIQUE UNIVERSAL SUTURING FORCEPS</i> .....	105
8 <b>G-15020</b> <i>GIESSEN LACRIMAL PROBE</i> angled.....	183	25 <b>G-18810</b> <i>DRAEGER CONJUNCTIVA FORCEPS</i> atraumatic.....	102
9 <b>G-150401</b> <i>WILDER LACRIMAL PROBE</i> slim, long taper.....	183	26 <b>G-34290</b> <i>SINGLE-USE LACRIMAL CANNULA</i> curved, 26G.....	224
10 <b>G-150302</b> <i>WILDER LACRIMAL PROBE</i> medium.....	183	27 <b>G-15190</b> <i>ANEL LACRIMAL CANNULA</i> straight, 23G.....	189
11 <b>G-18620</b> <i>HEIDELBERG RASPATORY</i> .....	242	28 <b>G-15195</b> <i>ANEL LACRIMAL CANNULA</i> round curve, 23G.....	189
12 <b>G-18630</b> <i>HEIDELBERG ELEVATORIUM</i> .....	242	29 <b>G-19030</b> <i>TUEBINGEN TYING FORCEPS</i> straight.....	106
13 <b>G-18240</b> <i>BONE CHISEL</i> flat, 5.0 mm wide.....	243	30 <b>G-15542</b> <i>AXENFELD LACRIMAL SAC RETRACTOR</i> .....	37
14 <b>G-18245</b> <i>BONE CHISEL</i> hollow, 5.0 mm wide.....	243	31 <b>G-19485</b> <i>STEVENS TENOTOMY SCISSORS</i> curved, long.....	89
15 <b>G-15095</b> <i>PIGTAIL PROBE</i> with suture holes.....	184	32 <b>G-19355</b> <i>EYE SCISSORS</i> straight, sharp tips, 10 cm.....	91
16 <b>G-34812</b> <i>LACRIMAL INTUBATION SET</i> olive tips, 27G.....	224	33 <b>G-17575</b> <i>CASTROVIEJO NEEDLE HOLDER</i> curved, w. lock.....	142
17 <b>G-32726</b> <i>MUENSTER SUTURE HOOK</i> .....	172		

STRABISMUS / MUSCLE

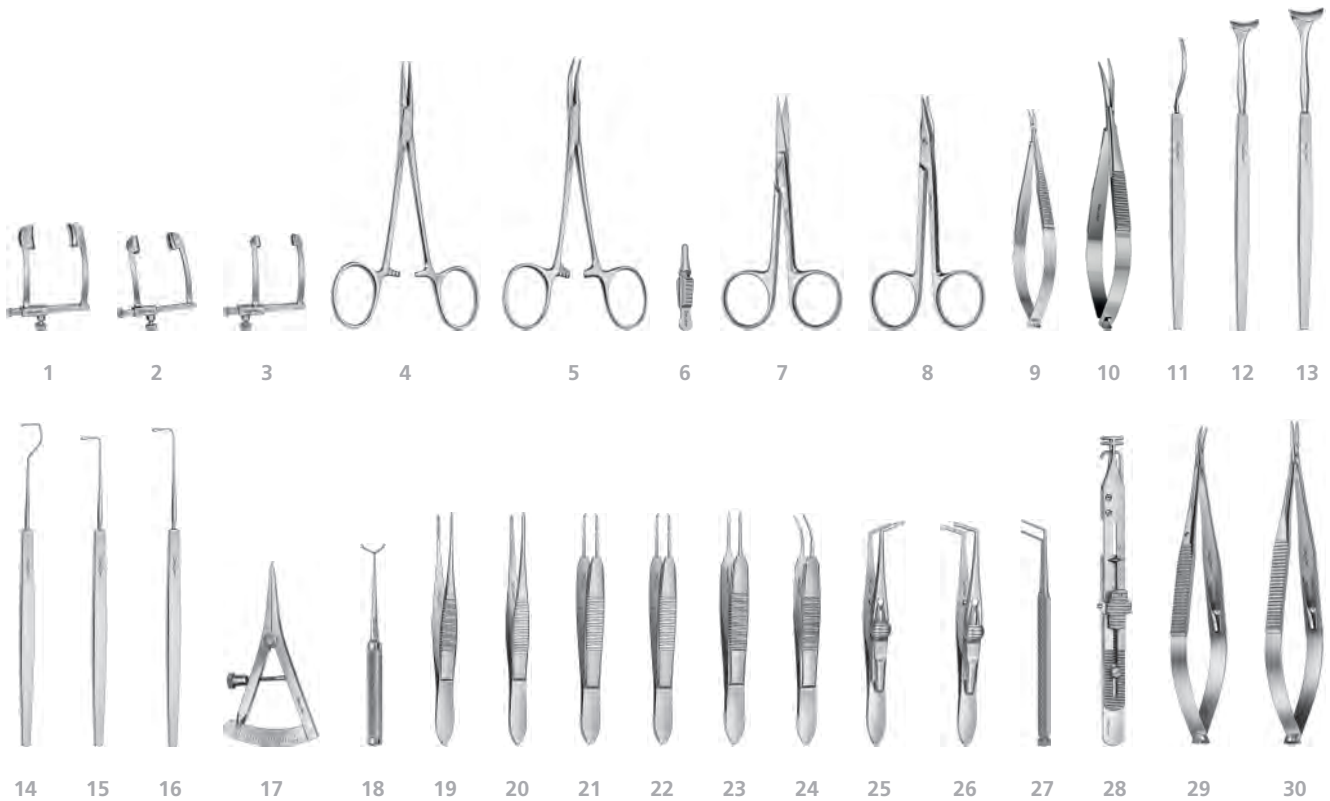

		page			page
1	<b>G-15995 COOK EYE SPECULUM</b> medium, 11 mm.....	23	16	<b>G-15805 GRAEFE STRABISMUS HOOK</b> medium, 10 mm.....	173
2	<b>G-16000 COOK EYE SPECULUM</b> small, 8 mm.....	24	17	<b>G-19135 CASTROVIEJO CALIPER</b> 20 mm.....	43
3	<b>G-32128 COOK EYE SPECULUM</b> infants, 5 mm.....	24	18	<b>G-15797 FINK MARKER</b> for 9 mm recession.....	44
4	<b>G-18180 HALSTEAD MOSQUITO FORCEPS</b> straight.....	135	19	<b>G-18782 DRESSING FORCEPS</b> serrated, 1.0 mm.....	110
5	<b>G-18181 HALSTEAD MOSQUITO FORCEPS</b> curved.....	135	20	<b>G-18810 DRAEGER CONJUNCTIVA FORCEPS</b> atraumatic.....	102
6	<b>G-18190 DIEFFENBACH SERREFINE</b> straight, 35 mm.....	136	21	<b>G-19010 CASTROVIEJO SUTURING FORCEPS</b> 0.6 mm.....	103
7	<b>G-19355 EYE SCISSORS</b> straight, sharp tips, 10 cm.....	91	22	<b>G-19005 CASTROVIEJO SUTURING FORCEPS</b> 0.3 mm.....	103
8	<b>G-19475 STEVENS TENOTOMY SCISSORS</b> curved, short.....	89	23	<b>G-19030 TUEBINGEN TYING FORCEPS</b> straight.....	106
9	<b>G-19600 CORNEAL SCISSORS</b> light curve, sharp tips.....	82	24	<b>G-19040 TUEBINGEN TYING FORCEPS</b> curved.....	106
10	<b>G-19750 WESTCOTT SCISSORS</b> blunt tips, curved, 12 cm.....	89	25	<b>G-19120 SATTLER MUSCLE FORCEPS</b> w. slide lock, right.....	127
11	<b>G-32225 VOGT SCLERAL RULER</b> .....	44	26	<b>G-19125 SATTLER MUSCLE FORCEPS</b> w. slide lock, left.....	127
12	<b>G-16060 DESMARRES LID RETRACTOR</b> fig. 1.....	35	27	<b>G-19112 BANGERTER MUSCLE FORCEPS</b> .....	126
13	<b>G-16065 DESMARRES LID RETRACTOR</b> fig. 2.....	35	28	<b>G-19137 CUEPPERS STRABISMUS MUSCLE TUCKER</b> .....	42
14	<b>G-15830 MALBRAN STRABISMUS HOOK</b> .....	174	29	<b>G-17575 CASTROVIEJO NEEDLE HOLDER</b> curved, w. lock.....	142
15	<b>G-15800 GRAEFE STRABISMUS HOOK</b> small, 8 mm.....	173	30	<b>G-17565 CASTROVIEJO NEEDLE HOLDER</b> straight, w. lock.....	142

STRABISMUS / MUSCLE

RETINAL DETACHMENT

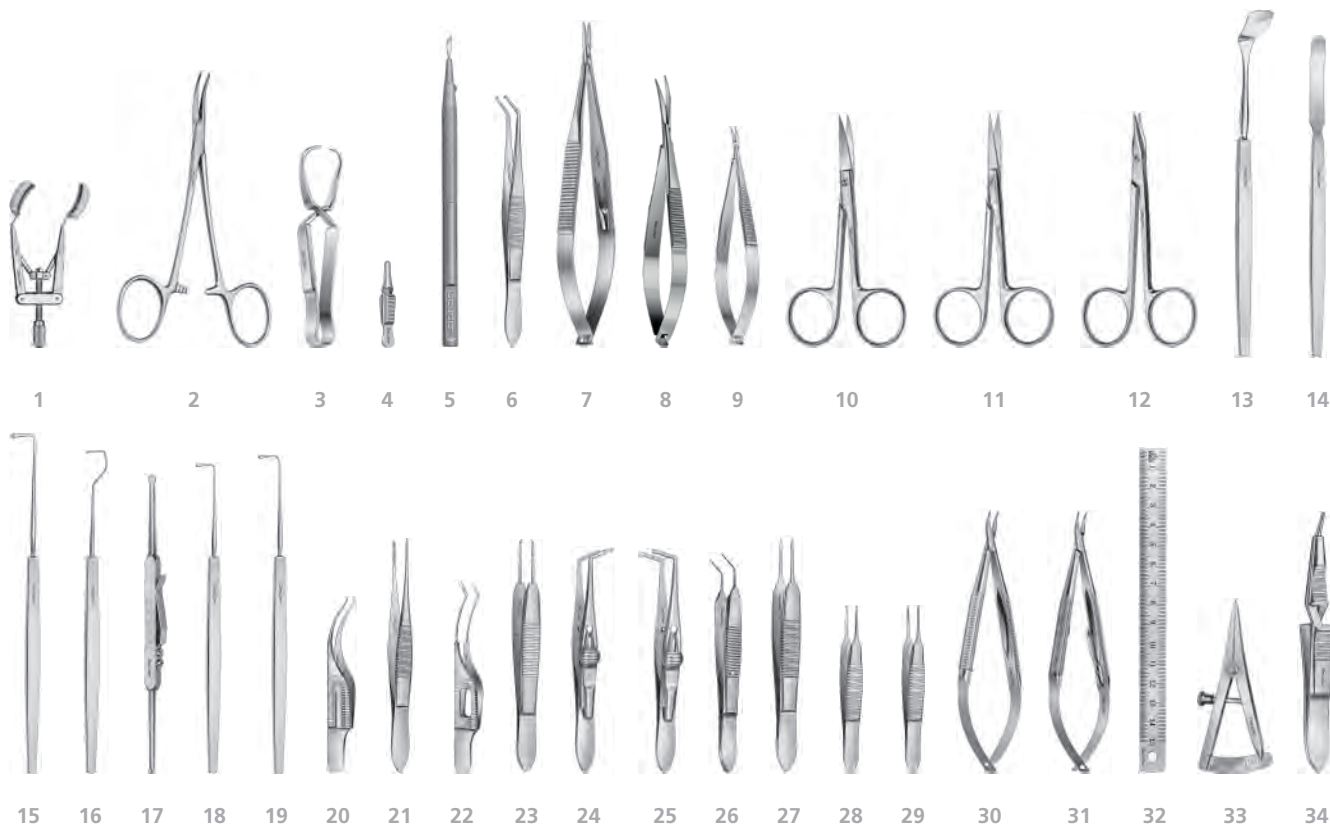

	page		page
1 <b>G-15966</b> <i>KERSHNER EYE SPECULUM</i> solid blades.....	25	18 <b>G-15800</b> <i>GRAEFE STRABISMUS HOOK</i> small, 8 mm.....	173
2 <b>G-18182</b> <i>HALSTEAD MOSQUITO FORCEPS</i> curved, 1x2 teeth.....	135	19 <b>G-15805</b> <i>GRAEFE STRABISMUS HOOK</i> medium, 10 mm.....	173
3 <b>G-33200</b> <i>SCHAEDEL TOWEL FORCEPS</i> .....	136	20 <b>G-18950</b> <i>COLIBRI FORCEPS</i> with tying platform.....	104
4 <b>G-18190</b> <i>DIEFFENBACH SERREFINE</i> straight, 35 mm.....	136	21 <b>G-18782</b> <i>DRESSING FORCEPS</i> serrated, 1.0 mm.....	110
5 <b>G-34026</b> <i>NANOEDGE PARACENTESIS KNIFE 15°</i> straight.....	217	22 <b>G-18792</b> <i>DRESSING FORCEPS</i> 1 x 2 teeth, 1.0 mm.....	110
6 <b>G-18820</b> <i>REMKY SUPERIOR RECTUS FORCEPS</i> .....	125	23 <b>G-19005</b> <i>CASTROVIEJO SUTURING FORCEPS</i> 0.3 mm.....	103
7 <b>G-17565</b> <i>CASTROVIEJO NEEDLE HOLDER</i> straight, w. lock.....	142	24 <b>G-19120</b> <i>SATTLER MUSCLE FORCEPS</i> w slide lock, right.....	127
8 <b>G-19750</b> <i>WESTCOTT SCISSORS</i> blunt tips, curved, 12 cm.....	89	25 <b>G-19125</b> <i>SATTLER MUSCLE FORCEPS</i> w slide lock, left.....	127
9 <b>G-19600</b> <i>CORNEAL SCISSORS</i> light curve, sharp tips.....	82	26 <b>G-19032</b> <i>TYING FORCEPS</i> angled, 7.5 mm.....	107
10 <b>G-19375</b> <i>EYE SCISSORS</i> curved, sharp tips, 10 cm.....	91	27 <b>G-19030</b> <i>TUEBINGEN TYING FORCEPS</i> straight.....	106
11 <b>G-19355</b> <i>EYE SCISSORS</i> straight, sharp tips, 10 cm.....	91	28 <b>G-31953</b> <i>IRIS FORCEPS</i> straight, 1 x 2 teeth, strong.....	111
12 <b>G-19475</b> <i>STEVENS TENOTOMY SCISSORS</i> curved, short.....	89	29 <b>G-18855</b> <i>IRIS FORCEPS</i> straight, serrated.....	110
13 <b>G-32445</b> <i>HAMBURG ORBITAL SPATULA</i> 18 x 12 mm.....	162	30 <b>G-17500</b> <i>BARRAQUER NEEDLE HOLDER</i> curved, w/o lock.....	139
14 <b>G-15720</b> <i>BANGERTER SPATULA</i> 6 mm wide.....	162	31 <b>G-17501</b> <i>BARRAQUER NEEDLE HOLDER</i> curved, w. lock.....	139
15 <b>G-15821</b> <i>BONN STRABISMUS HOOK</i> 1.0 mm hole.....	174	32 <b>G-18650</b> <i>RULER</i> 150 mm, 0.5 mm increments.....	43
16 <b>G-15830</b> <i>MALBRAN STRABISMUS HOOK</i> .....	174	33 <b>G-19130</b> <i>CASTROVIEJO CALIPER</i> 15 mm.....	43
17 <b>G-32150</b> <i>LAQUA SCLERAL DEPRESSOR</i> double-ended.....	179	34 <b>G-33752</b> <i>WATZKE SPREADING FORCEPS</i> .....	127

VITRECTOMY 20G

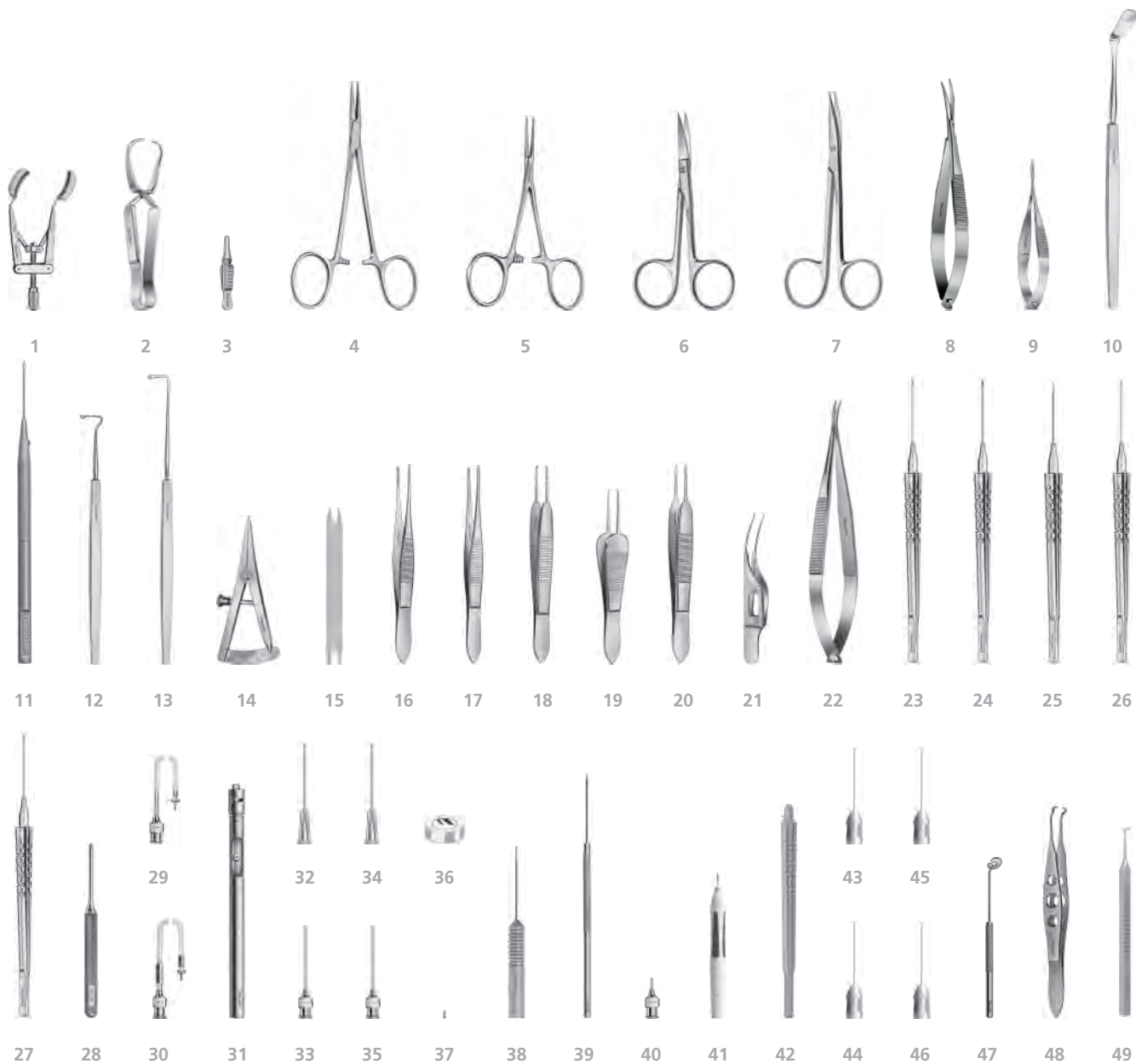

VITRECTOMY 20G

	page		page
1	25	29	209
2	136	30	209
3	136	31	206
4	135	32	227
5	135	33	207
6	91	34	227
7	89	35	207
8	89	36	244
9	84	37	128
10	163	38	175
11	217	39	175
12	174	40	210
13	174	41	221
14	43		
15	43	42	218
16	110	43	219
17	102	44	218
18	103	45	219
19	105		
20	106	46	219
21	104	47	150
22	142	48	129
23	130	49	175
24	130	50	249
25	130	51	249
26	95	52	250
27	95	53	249
28	246		

VITRECTOMY 23G

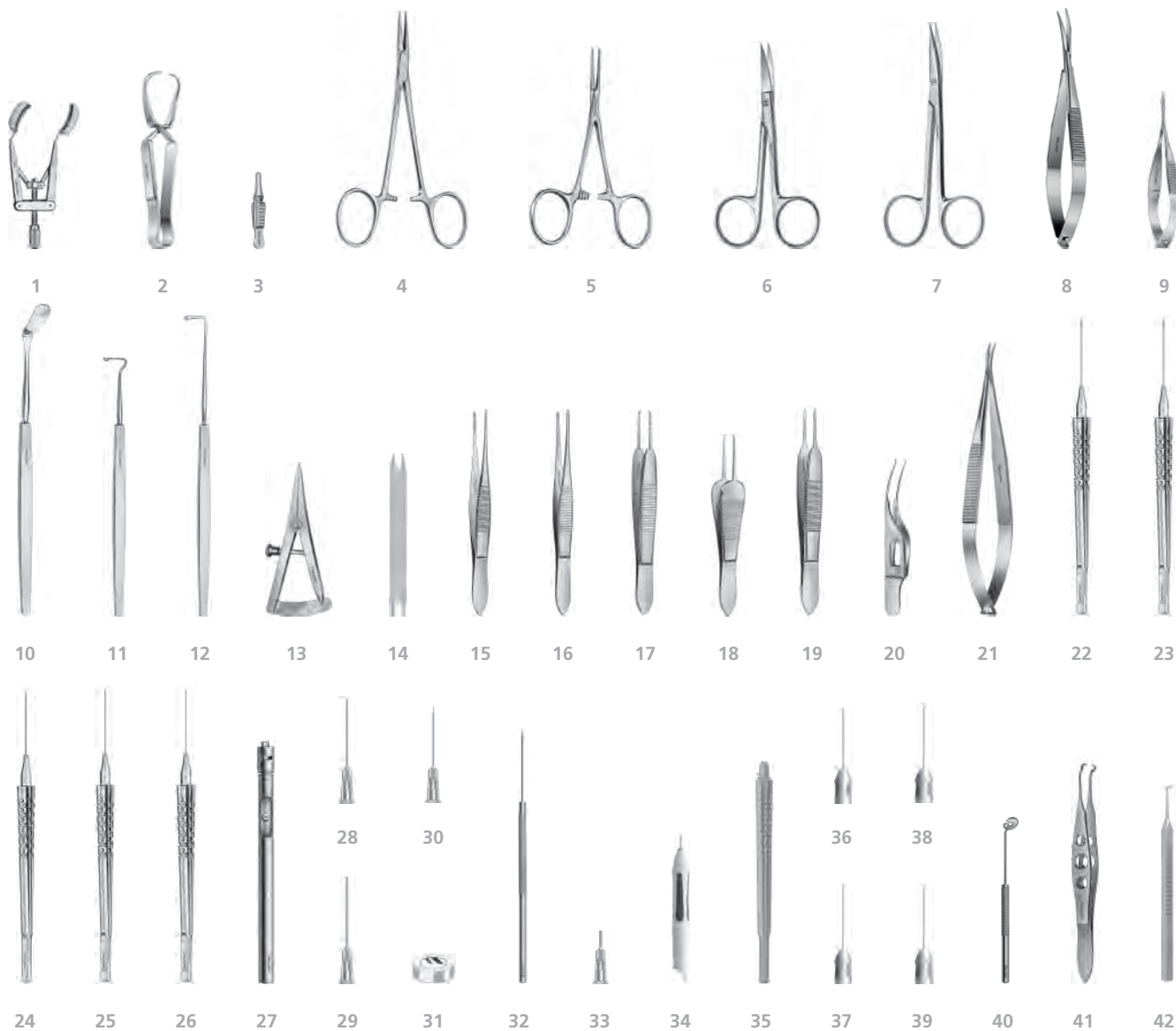

VITRECTOMY 23G



	page		page
1	25	26	96
2	136	<b>G-36540</b>	HEIMANN VITREORETINAL SCISSORS 23G, angled, for trocars.....
3	136	27	206
4	135	<b>G-37002</b>	BACKFLUSH HANDPIECE with silicone chamber.....
5	135	28	227
6	91	<b>G-34296</b>	SINGLE-USE BACKFLUSH CANNULA 23G.....
7	89	29	227
8	89	<b>G-34294</b>	SINGLE-USE BACKFLUSH CANNULA 23 G w brush.....
9	84	30	228
10	163	<b>G-34285</b>	SINGLE-USE PFCL CANNULA coaxial, 23G.....
11	174	31	244
12	174	<b>G-36000</b>	KILP LENS 60 D flat, field of vision 20°.....
13	43	32	175
14	43	<b>G-37512</b>	MEMBRANE PEELER 0.4 mm, recessed, angled, 23G.....
15	110	33	228
16	102	<b>G-34498</b>	SINGLE USE CANNULA for silicone oil, 23G.....
17	103	34	221
18	105	<b>G-42311</b>	HATTENBACH / NIKOLIC UNO C TROCAR SYSTEM 23G.....
19	106	35	218
20	104	<b>G-40006</b>	HANDLE UNO C 6 mm, titanium.....
21	142	36	218
22	132	<b>G-42361</b>	UNO C VITREOUS SCISSORS 23G, straight.....
23	132	37	219
24	132	<b>G-46341</b>	UNO C VITREOUS FORCEPS ENDGRIPPING 23G.....
25	96	38	219
		<b>G-46343</b>	UNO C VITREOUS FORCEPS CROCODILE DESIGN 23G.....
		39	219
		<b>G-42344</b>	TANO UNO C FORCEPS 23G.....
		40	150
		<b>G-37425</b>	FIXATION INSTRUMENT for trocar systems.....
		41	129
		<b>G-37430</b>	TROCAR FORCEPS.....
		42	175
		<b>G-37435</b>	HATTENBACH HORSESHOE-HOOK.....
		43	249
		<b>G-39786</b>	MICROSTOP <sup>®</sup> TRAY MINI low, with lid.....
		44	249
		<b>G-39783</b>	MICROSTOP <sup>®</sup> TRAY MINI low, without lid.....
		45	250
		<b>G-39782</b>	MICROSTOP <sup>®</sup> RETAINER ELEMENT low.....
		46	249
		<b>G-39750</b>	MICROSTOP <sup>®</sup> CONTAINER HIGH for two trays.....

VITRECTOMY 25G

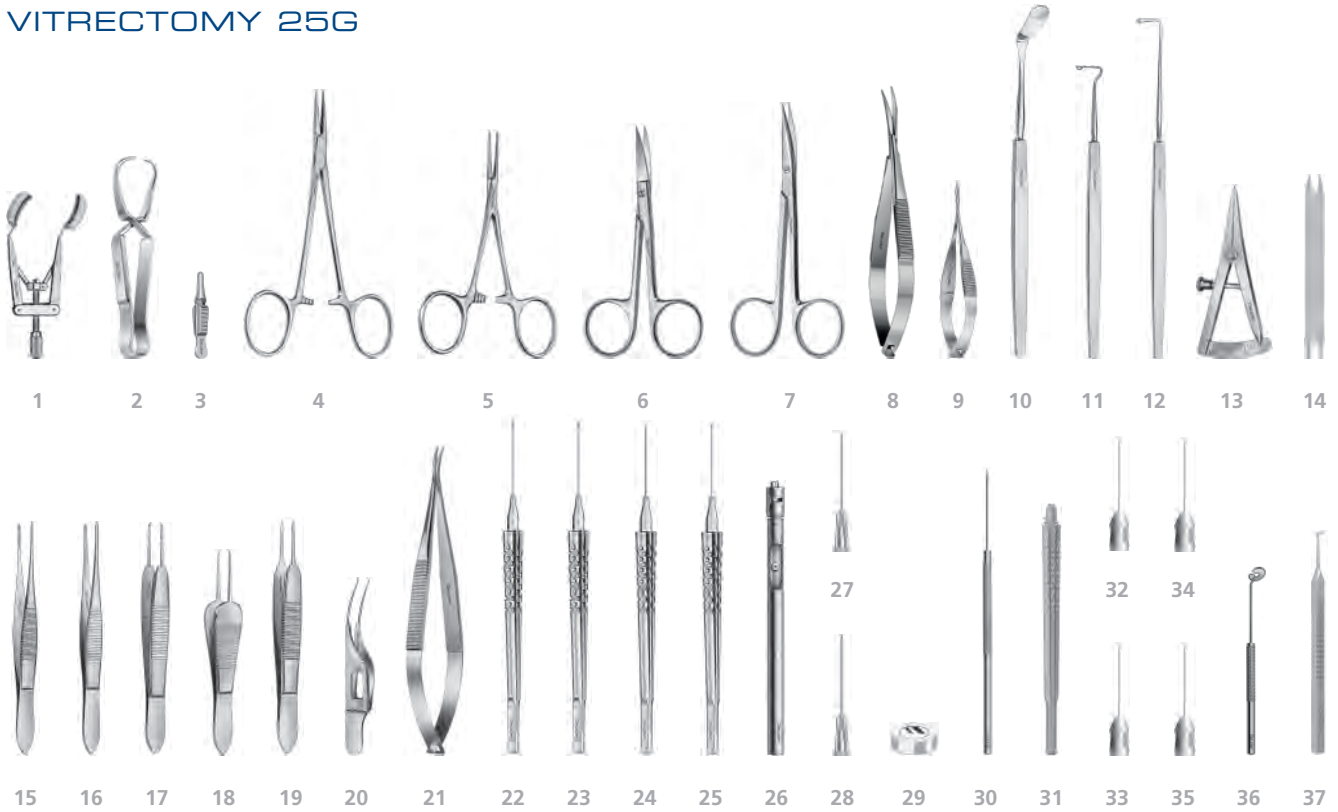

		page			page
1	<b>G-15966</b> KERSHNER EYE SPECULUM solid blades.....	25	22	<b>G-36312</b> VITREORETINAL FORCEPS endgripping, 25G.....	132
2	<b>G-33200</b> SCHAEDEL TOWEL FORCEPS.....	136	23	<b>G-36322</b> VITREORETINAL FORCEPS crocodile, 25G.....	132
3	<b>G-18190</b> DIEFFENBACH SERREFINE straight, 35 mm.....	136	24	<b>G-36366</b> TANO VITREORETINAL FORCEPS serrated, 25G.....	132
4	<b>G-18180</b> HALSTEAD MOSQUITO FORCEPS straight.....	135	25	<b>G-36586</b> HEIMANN VITREORETINAL SCISSORS straight, 25G.....	96
5	<b>G-18170</b> HARTMANN MOSQUITO FORCEPS straight.....	135	26	<b>G-37002</b> BACKFLUSH HANDPIECE with silicone chamber.....	206
6	<b>G-19375</b> EYE SCISSORS curved, sharp tips, 10 cm.....	91	27	<b>G-34299</b> SINGLE-USE BACKFLUSH CANNULA 25G.....	227
7	<b>G-19485</b> STEVENS TENOTOMY SCISSORS curved, long.....	89	28	<b>G-34297</b> SINGLE-USE BACKFLUSH CANNULA 25G w brush.....	227
8	<b>G-19750</b> WESTCOTT SCISSORS blunt tips, curved, 12 cm.....	89	29	<b>G-36000</b> KILP LENS 60 D flat, field of vision 20°.....	244
9	<b>G-19760</b> VANNAS CAPSULOTOMY SCISSORS straight.....	84	30	<b>G-37513</b> MEMBRANE PEELER 0.4 mm, recessed, angled, 25G.....	175
10	<b>G-32446</b> ORBITAL SPATULA 18 x 8 mm.....	163	31	<b>G-40006</b> HANDLE UNO C 6 mm, titanium.....	218
11	<b>G-32920</b> JAMESON STRABISMUS HOOK 11 mm.....	174	32	<b>G-42561</b> UNO C VITREOUS SCISSORS 25G, straight.....	218
12	<b>G-15821</b> BONN STRABISMUS HOOK 1.0 mm hole.....	174	33	<b>G-46541</b> UNO C VITREOUS FORCEPS ENDGRIPPING 25G.....	219
13	<b>G-19130</b> CASTROVIEJO CALIPER 15 mm.....	43	34	<b>G-46542</b> HATTENBACH UNO C VITREOUS FORCEPS 25G wave design.....	219
14	<b>G-37410</b> MARKING INSTRUMENT.....	43	35	<b>G-42544</b> TANO UNO C FORCEPS 25G.....	219
15	<b>G-18782</b> DRESSING FORCEPS serrated, 1.0 mm.....	110	36	<b>G-37425</b> FIXATION INSTRUMENT for trocar systems.....	150
16	<b>G-18810</b> DRAEGER CONJUNCTIVA FORCEPS atraumatic.....	102	37	<b>G-37435</b> HATTENBACH HORSESHOE-HOOK.....	175
17	<b>G-19010</b> CASTROVIEJO SUTURING FORCEPS 0.6 mm.....	103	38	<b>G-39786</b> MICROSTOP® TRAY MINI low, with lid.....	249
18	<b>G-18940</b> PAUFIQUE UNIVERSAL SUTURING FORCEPS.....	105	39	<b>G-39783</b> MICROSTOP® TRAY MINI low, without lid.....	249
19	<b>G-19030</b> TUEBINGEN TYING FORCEPS straight.....	106	40	<b>G-39782</b> MICROSTOP® RETAINER ELEMENT low.....	250
20	<b>G-18960</b> MICRO COLIBRI FORCEPS with tying platform.....	104	41	<b>G-39750</b> MICROSTOP® CONTAINER HIGH for two trays.....	249
21	<b>G-17570</b> CASTROVIEJO NEEDLE HOLDER curved, w/o lock.....	142			

# IN

INDEX

**Geuder**<sup>®</sup>  
Precision made in Germany

# NUMERICAL INDEX

ITEM NO. ....	PAGE	ITEM NO. ....	PAGE	ITEM NO. ....	PAGE	ITEM NO. ....	PAGE
<b>G-12...</b>		15189 .....	193	15750 .....	162	16070 .....	36, S16
12200 .....	66	15190 .....	189, S17	15755 .....	166	16075 .....	36
12220 .....	66	15195 .....	189, S17	15757 .....	167	16080 .....	35
		15197 .....	226	15758 .....	163, S9	16105 .....	191
		15200 .....	191, S3, S13	15780 .....	167, S14	16106 .....	194, S2, S4
<b>G-14...</b>		15220 .....	191	15797 .....	44, S18	16115 .....	193, S2
14000 .....	63	15225 .....	195	15799 .....	173, S13	16120 .....	195
14010 .....	64, S14, S16	15226 .....	195	15800 .....	173, S16, S18-S19	16125 .....	195, S2
14020 .....	64, S9	15230 .....	194	15805 .....	173, S13, S16, S18-S19	16130 .....	195, S6
14105 .....	63, S12	15240 .....	194	15810 .....	173, S14	16132 .....	195
14162 .....	65	15250 .....	192, S3-S5, S9, S12	15820 .....	174	16133 .....	195
14165 .....	65	15271 .....	190	15821 .....	174, S13, S19,	16134 .....	194
14180 .....	63	15272 .....	190	.....	S21, S23-S24	16135 .....	194
14185 .....	63	15273 .....	190	15830 .....	174, S18, S19	16136 .....	194
14200 .....	64, S9	15275 .....	192	15840 .....	52	16138 .....	194
14420 .....	63	15310 .....	197, S10	15845 .....	52	16160 .....	156
14480 .....	56	15312 .....	197, S10	15870 .....	51, S15, S16	16161 .....	156
14490 .....	56	15314 .....	197	15875 .....	51, S15, S16	16166 .....	156
14500 .....	56	15315 .....	186	15880 .....	51, S15	16167 .....	156, S2-S4
14530 .....	55, 266	15350 .....	38	15885 .....	51	16169 .....	157
14540 .....	55, 266	15355 .....	38, S16	15900 .....	51, S16	16175 .....	154, 157, S2
14550 .....	55, 266, S13, S15	15360 .....	166	15910 .....	52, S15	16181 .....	154
14570 .....	56	15365 .....	166	15920 .....	31	16182 .....	154
		15370 .....	166	15921 .....	31	16185 .....	155
		15375 .....	191	15925 .....	31	16189 .....	153, 159, S2-S3
<b>G-15...</b>		15376 .....	191	15926 .....	31	16190 .....	159, S12
15020 .....	183, S17	15377 .....	191	15928 .....	32	16191 .....	158
15050 .....	184	15390 .....	165	15945 .....	20	16193 .....	158
15055 .....	184	15391 .....	165	15946 .....	20	16200 .....	65
15065 .....	150, S9	15392 .....	48	15950 .....	21	16205 .....	158
15070 .....	150, S9	15393 .....	48	15951 .....	21	16210 .....	157
15075 .....	150, S9	15400 .....	165	15955 .....	21		
15080 .....	150, S9	15405 .....	165	15956 .....	22	<b>G-17...</b>	
15085 .....	150, S9	15470 .....	164	15960 .....	25, S2-S4, S7-S8,	17000 .....	24
15090 .....	150, S9	15475 .....	164	.....	S10, S12-S13	17001 .....	24
15095 .....	184, S17	15477 .....	163	15961 .....	28, S7, S8	17002 .....	25
15096 .....	184	15480 .....	164	15962 .....	29	17003 .....	25
15105 .....	186	15485 .....	164	15965 .....	25, S14	17004 .....	17
15110 .....	186	15540 .....	37	15966 .....	25, S9, S19, S21,	17005 .....	27
15125 .....	186, S12	15542 .....	37, S16-S17	.....	S23-S24	17006 .....	27
15130 .....	186, S12	15545 .....	37	15970 .....	22	17010 .....	18
15134 .....	104	15550 .....	37	15975 .....	22	17011 .....	18
15136 .....	186	15555 .....	37	15990 .....	23, S14	17015 .....	18
15137 .....	186	15560 .....	37	15995 .....	23, S13, S18	17016 .....	18
15138 .....	186	15620 .....	161, S2, S4			17017 .....	18
15140 .....	189	15630 .....	161	<b>G-16...</b>		17019 .....	27
15141 .....	189, S13	15635 .....	161	16000 .....	24, S18	17020 .....	15, S2, S12, S15
15150 .....	189	15640 .....	161	16010 .....	23	17021 .....	27
15151 .....	189, S3, S13	15645 .....	161	16020 .....	23	17023 .....	15, S13
15160 .....	189	15710 .....	180	16025 .....	23	17024 .....	28
15161 .....	189	15720 .....	162, S19	16030 .....	23	17025 .....	15
15170 .....	190	15725 .....	162	16050 .....	21	17026 .....	15
15180 .....	194, S7	15730 .....	162	16055 .....	21	17027 .....	19
15185 .....	192, S2, S12-S13	15731 .....	162	16060 .....	35, S13, S16, S18	17030 .....	19
15188 .....	193	15740 .....	162	16065 .....	35, S13, S16, S18	17031 .....	29
		15745 .....	162				

ITEM NO. ....	PAGE	ITEM NO. ....	PAGE	ITEM NO. ....	PAGE	ITEM NO. ....	PAGE
17040	36, S15-S16	18160	136	.....	S23-S24	19026	103
17070	38, S17	18170	135, S16, S21, S23-S24	18820	125, S2, S12, S19	19030	106, S2-S3, S9-S10,
17080	38	18171	135, S16	18840	111	.....	S12-S13, S17-S19,
17085	38	18180	135, S2, S9, S12, S14,	18845	111	.....	S21, S23-S24
17250	69	.....	S17-S18, S21, S23-S24	18846	112	19032	107, S2-S3, S13, S19
17251	69	18181	135, S13-S14, S17-S18	18847	102	19034	106
17260	69	18182	135, S19	18848	102	19035	106
17261	69	18185	135	18850	101, S13, S15	19038	107
17270	69	18190	136, S2, S18-S19,	18855	110	19040	106, S9-S10, S16, S18
17271	69	.....	S21, S23-S24	18856	110	19045	105
17280	69	18195	136	18857	111	19046	105
17281	69	18197	136	18860	111	19048	107
17290	69	18210	75	18870	111	19050	109, S14, S16
17291	69	18220	75	18880	112	19055	109
17300	69	18225	75, S17	18890	111	19060	109
17440	88, 143	18232	77	18897	112	19080	109, S14
17441	88, 143	18235	76	18900	110, S12	19105	126
17450	139, S9	18237	77	18905	110	19107	127
17451	139	18238	76, S12	18906	110	19112	126, S14, S18
17452	139	18239	76, S12	18908	110	19120	127, S18-S19
17453	139	18240	243, S17	18910	110, S2	19125	127, S18-S19
17460	139	18245	243, S17	18911	110	19130	43, S2-S3, S12-S13,
17461	139	18300	244, S14	18913	112	.....	S16, S19, S21, S23-S24
17462	139	18301	244	18914	119, S7-S8	19135	43, S18
17463	139	18302	244	18918	122	19137	42, 172, S18
17500	139, S2-S4, S9,	18620	242, S17	18919	122	19138	43
.....	S12-S13, S19	18630	242, S17	18928	123	19230	48, S12
17501	139, S19	18645	44	18930	122	19270	145
17505	139, S10	18650	43, S19	18935	121, S2, S4	19300	145
17506	139	18670	134	18940	105, S14, S17,	19320	145
17510	140	18680	134, S15-S16	.....	S21, S23-S24	19330	145
17511	140	18685	134, S15-S16	18941	125	19345	62
17515	140	18690	134	18944	123	19350	91
17516	140	18695	134	18945	105	19355	91, S14, S16-S19
17520	141	18700	134	18950	104, S4, S13, S19	19360	91
17525	141	18710	134, S15-S16	18960	104, S2-S3, S9, S16,	19365	91
17530	140	18715	134, S16	.....	S21, S23-S24	19370	91
17535	140	18720	101	18965	104	19375	91, S14-S15, S19,
17540	142	18730	101	18966	104	.....	S21, S23-S24
17545	142	18740	101	18970	105	19380	91
17560	142	18750	101	18972	104, S9	19385	91
17565	142, S12-S13, S18-S19	18780	110	18975	104	19390	92
17570	142, S14, S21, S23-S24	18781	110	<b>G-19...</b>		19395	92
17575	142, S2, S14-S18	18782	110, S13-S14,	19001	103, S9	19400	92, S2-S4, S9, S12
17610	143	.....	S17-S19, S21, S23-S24	19005	103, S13, S16, S18-S19	19405	92
17615	143	18783	110	19008	103	19410	92
17640	144	18784	110	19010	103, S9, S13, S16,	19420	90
17645	144	18790	110	.....	S18, S21, S23-S24	19425	90
17650	144	18791	110, S2, S9, S12, S15	19015	103	19430	90
17660	144	18792	110, S12, S14, S15, S19	19020	103	19435	90
17665	144	18793	110	19022	103	19450	93
<b>G-18...</b>		18794	110	19023	103, S3	19460	91
18127	145, 231, S7-S8	18795	126	19024	103	19465	91
18150	145, S7-S8	18800	126	19025	103	19470	89
		18805	117			19475	89, S18-S19
		18810	102, S16-S18, S21,			19480	89, S16

ITEM NO. ....	PAGE	ITEM NO. ....	PAGE	ITEM NO. ....	PAGE	ITEM NO. ....	PAGE
19485	89, S3, S13-S14, S17, S21, S23-S24	19856	253	20618	69	<b>G-31 ...</b>	
19505	93	19865	257			31013	264
19510	93	19866	257	<b>G-21 ...</b>		31014	266
19520	94	19867	257	21175	72	31016	265
19525	94, S14	19870	256	21176	72	31017	265
19530	94	19876	253, 255			31018	265
19540	86	19877	254-255	<b>G-22 ...</b>		31021	264
19545	86	19890	255	22100	198, S3, S5	31022	265
19550	86	19892	254-255	22101	199, S3, S5	31023	265
19570	82	19899	257	22102	198	31024	265
19580	82	19960	212	22105	199	31025	264
19585	82	19961	212	22106	199	31026	264
19590	83			22107	199	31027	265
19600	82, S16, S18-S19	<b>G-20 ...</b>		22525	205	31028	264
19605	82	20050	69	22527	205	31029	264
19607	82	20054	69	22540	205	31031	265
19615	82	20055	69	22542	205	31034	266
19620	84	20060	69	22545	205	31105	245
19630	84, S12	20065	69	22550	197	31230	102
19640	86	20070	69	22556	205	31235	102
19655	86	20080	69	22615	205	31299	114
19660	87	20090	69	22619	193, S12	31300	113
19675	87	20100	69	22632	198	31301	114
19680	87, S12	20216	245	22633	198	31303	114
19690	81	20217	245	22636	264	31304	113
19695	81	20218	245	22637	199	31305	114, S2-S3
19710	81, S2	20219	245			31306	115
19715	81, S2	20220	245	<b>G-23 ...</b>		31307	113, S4
19718	81	20316	245	23991	231	31308	113
19720	81, S9-S10	20317	245			31315	94
19725	81, S9-S10	20318	245	<b>G-24 ...</b>		31355	192
19727	82	20319	245	24100	204-205	31378	160
19740	83	20320	245	24311	203	31415	136
19745	83	20416	245, S14	24314	204	31420	136
19747	83	20417	245, S14	24318	203	31468	61
19750	89, S2, S9, S12-S13, S16, S18-S19, S21, S23-S24	20418	245, S14	24330	204	31470	61, S12
19751	89	20419	245, S14	24332	204	31477	62
19760	84, S21, S23-S24	20420	245, S14	24418	203	31480	62
19765	84, S2-S4, S9, S13, S15	20450	69	24430	204	31487	62, S12
19770	84, S10	20455	69	24432	204	31490	149
19775	85	20460	69	24435	204	31491	149
19776	83, S2	20465	69	24440	204	31500	151
19777	83	20470	69			31501	151
19780	81	20480	69	<b>G-28 ...</b>		31502	151
19790	81	20490	69	28150	252, 255	31503	151
19820	246	20500	69	28151	252, 255	31504	151
19822	252, 255	20610	69	28752	211	31505	152
19823	252, 255	20611	69	28766	230	31506	152
19825	246	20612	69, S12	28767	230	31507	152-154, S3, S5
19841	255, 257	20613	69	28768	230	31510	193
19842	254-255, 257	20614	69			31518	120
19843	253, 255, 257	20615	69			31519	120
19846	257	20616	69			31520	229
19847	257	20617	69			31545	52, S14
						31555	52, S14

ITEM NO. ....	PAGE	ITEM NO. ....	PAGE	ITEM NO. ....	PAGE	ITEM NO. ....	PAGE
31570	128	32005	159	32224	42	32714	180
31620	101	32007	159	32225	44, S18	32715	180
31622	108, S4	32010	198	32227	158	32724	160
31623	108	32011	200, S5	32228	42	32726	172, S17
31624	108	32012	200, S5	32229	42, S9	32727	163
31625	107	32014	202	32240	112	32728	159, S10
31649	255	32015	197	32250	89	32729	166
31650	255	32016	201	32260	140	32740	101
31651	255	32017	201	32261	140	32759	193
31652	255	32018	200	32275	157	32760	194
31656	255	32019	200	32276	157	32765	194
31657	258	32023	84	32282	152	32769	196
31659	258	32026	201	32313	243	32771	198
31661	255	32027	179	32315	141	32772	196
31670	263	32028	201	32318	45, S9	32773	198
31720	120, S3	32034	155	32320	141	32774	196
31722	120	32059	202	32321	141	32776	196
31724	121	32100	83	32335	126	32778	198
31727	154	32101	83	32350	127	32785	256
31805	206	32105	83	32355	242, S17	32800	88, S4
31806	206	32115	36	32445	162, S19	32810	88
31807	193	32119	19	32446	163, S21, S23-S24	32811	88
31810	242, S17	32120	35, S13-S15	32500	152-153	32823	125, S4
31815	69	32126	17	32501	153	32905	174
31820	69	32127	17	32505	151, 153-154, S5	32915	173
31825	69	32128	24, S18	32523	159	32920	174, S13, S15, S21, S23-S24
31830	69	32129	17	32527	195	32926	115, S3, S5
31835	69	32130	20	32528	196	32928	115
31840	69	32133	17	32529	195	32935	115, S4
31845	69	32134	19	32530	156	32936	116
31850	69	32135	20	32550	155	32937	116
31855	69	32136	16, S4	32555	156	32938	116
31860	69	32137	16	32556	155	32940	85, S4
31865	69	32138	18	32557	156	32942	85
31870	70	32139	18	32563	160	32944	117, 264, S4
31891	229	32148	16, S3	32564	160, S6	32945	87, S4
31895	192	32149	16	32600	191	32946	87
31899	119	32150	179, S19	32605	191	32947	108, 264, S4, S6
31900	246, S21	32152	179	32614	90	32948	86, 264, S4, S6
31901	124, S3	32153	179	32660	256	32949	108, 143, S4, S6
31902	123	32155	192	32665	212	32955	241
31903	123	32160	153, 155	32670	212	32960	241, S4
31905	124, S4	32161	153	32671	71	32965	241
31908	124	32162	154, S3	32672	71	32970	241, S4
31911	158	32164	153	32674	71	32996	88, S4
31953	111, S16, S19	32165	121	32675	256	32997	125, S4, S6
31962	122	32166	192	32676	257	32998	88, S6
31975	166	32167	192, S11	32677	257		
31980	166	32168	153	32695	258		
31985	166	32169	154	32696	211, 229	<b>G-33...</b>	
31990	165	32180	209	32697	211	33022	64
31994	124, S4	32181	209, S21	32698	211	33025	64
		32182	209	32699	211	33026	64
<b>G-32...</b>		32209	44, S12	32700	231, S14-S15	33045	206
		32210	44, S12	32705	231, S14-S15	33050	207, S21
32004	44	32222	41	32710	231		

ITEM NO. ....	PAGE	ITEM NO. ....	PAGE	ITEM NO. ....	PAGE	ITEM NO. ....	PAGE
33051 .....	210	33450 .....	209	33873 .....	70	<b>G-34 ...</b>	
33052 .....	210, S21	33451 .....	209	33874 .....	70	34026 .....	217, S2-S3, S13, S16
33053 .....	207	33452 .....	209	33875 .....	70	34031 .....	217
33054 .....	207	33462 .....	228	33876 .....	70	34036 .....	217, S12
33055 .....	210, 265	33463 .....	228	33877 .....	70	34050 .....	217
33056 .....	210	33468 .....	228	33878 .....	70	34051 .....	217, S3
33057 .....	210, 266	33469 .....	228	33879 .....	70	34052 .....	217, S3
33059 .....	266	33470 .....	210	33880 .....	70	34053 .....	217
33065 .....	211	33471 .....	210	33881 .....	70	34054 .....	217
33066 .....	211	33472 .....	210	33882 .....	70	34055 .....	217, S3
33070 .....	207	33473 .....	210	33883 .....	70	34060 .....	217
33071 .....	207	33474 .....	210	33884 .....	70	34061 .....	217
33072 .....	207	33475 .....	210	33885 .....	70	34062 .....	217
33073 .....	207	33482 .....	228	33886 .....	70	34064 .....	217
33075 .....	207, S21	33484 .....	209	33887 .....	70	34081 .....	217
33077 .....	207	33485 .....	209	33888 .....	70	34086 .....	217
33080 .....	258	33486 .....	209	33889 .....	70	34122 .....	217
33090 .....	258	33488 .....	229	33890 .....	70	34126 .....	217
33100 .....	258	33489 .....	229	33891 .....	70	34146 .....	217, S2
33125 .....	242, S17	33494 .....	209	33892 .....	70	34181 .....	217, S21
33135 .....	189	33495 .....	209	33893 .....	70	34191 .....	217
33140 .....	189	33496 .....	209	33894 .....	70	34192 .....	217
33141 .....	265	33650 .....	243, S7	33895 .....	70	34196 .....	217
33142 .....	265	33652 .....	243, S7	33896 .....	70	34197 .....	217
33143 .....	265	33655 .....	243, S7	33897 .....	70	34198 .....	217
33160 .....	190	33657 .....	243, S7	33898 .....	70	34200 .....	224
33170 .....	190	33670 .....	64, S7	33899 .....	70	34205 .....	224
33175 .....	190	33725 .....	41	33909 .....	196, S7	34210 .....	224, S3
33180 .....	190	33726 .....	41	33910 .....	197, S7-S8	34215 .....	224
33185 .....	190	33727 .....	41, S9	33911 .....	197, S7	34220 .....	224
33190 .....	190	33740 .....	41	33912 .....	167, S7-S8	34225 .....	224, S2
33193 .....	186	33741 .....	41	33914 .....	30	34230 .....	224
33194 .....	186, S17	33742 .....	41	33919 .....	26	34235 .....	225
33195 .....	186	33745 .....	45, S7	33920 .....	26, S7	34240 .....	225
33197 .....	190	33746 .....	45, S7	33925 .....	30	34245 .....	225, S5
33198 .....	190, S17	33747 .....	45, S7	33930 .....	167, S8	34255 .....	226
33199 .....	193	33752 .....	127, S19	33935 .....	168	34261 .....	225
33200 .....	136, S12, S19, S21, S23-S24	33755 .....	149	33940 .....	170, S7	34265 .....	226
33416 .....	191, S10	33757 .....	150	33941 .....	108, S8	34270 .....	225
33420 .....	209	33758 .....	150, S3, S8	33942 .....	170	34271 .....	225
33422 .....	191	33759 .....	150, S7-S8	33943 .....	171, S7-S8	34275 .....	227
33425 .....	209, S21	33760 .....	46	33944 .....	172	34280 .....	226
33427 .....	171, S8	33762 .....	46	33950 .....	169, S8	34285 .....	228, S23
33428 .....	118, S7-S8	33763 .....	46, S6	33952 .....	170, S8	34289 .....	227
33429 .....	118, S8	33774 .....	46, S6	33954 .....	170	34290 .....	224, S17
33430 .....	209	33776 .....	47, S6	33958 .....	171	34291 .....	227, S21
33432 .....	128	33777 .....	47, S6	33959 .....	171, S8	34292 .....	228
33434 .....	127	33778 .....	47	33960 .....	119, S8	34293 .....	227, S21
33435 .....	128, S21	33780 .....	42	33961 .....	119, S8	34294 .....	227, S23
33436 .....	128	33781 .....	42	33965 .....	26, S5	34295 .....	228
33437T .....	128	33785 .....	45	33966 .....	169, S5	34296 .....	227, S23
33438 .....	128	33786 .....	231, S6-S7, S12, S16	33967 .....	169, S5	34297 .....	227, S24
33439 .....	128	33831 .....	129	33968 .....	169, S5	34298 .....	228
33440 .....	121	33870 .....	70	33971 .....	26	34299 .....	227, S24
33441 .....	128	33871 .....	70			34335 .....	226
		33872 .....	70				



ITEM NO. ....	PAGE	ITEM NO. ....	PAGE	ITEM NO. ....	PAGE	ITEM NO. ....	PAGE
34340	223	36090	259	36504	95	36955	97
34400	227	36202	130	36506	95	36975	97
34480	229	36206	130	36508	95	36985	97
34492	229	36208	130	36512	95		
34497	228	36212	130	36514	95		
34498	228, S23	36214	130	36516	95	<b>G-37...</b>	
34523	223, S2, S4	36216	130	36518	95	37000	206
34602	232	36218	130	36522	95	37002	206, S21, S23-S24
34610	232	36222	131	36524	95	37005	206
34616	232	36226	131	36526	95, S21	37006	206
34618	232	36232	131	36528	95	37010	206, 208, 265
34620	233	36236	131	36532	95, S21	37011	208
34622	233	36242	131	36534	95	37012	208
34624	233	36246	131	36536	95	37015	208
34626	233	36248	131	36538	95	37020	208
34632	234	36252	131	36540	96, S23	37025	208
34634	234	36254	131	36541	96	37035	208
34636	234	36256	130, S21	36546	95	37046	208
34642	234	36258	130	36548	95	37065	208
34644	234	36262	131	36552	95	37080	206, 209, 265
34645	235	36264	131	36554	95	37100	265
34646	234	36266	131	36556	95	37105	265
34647	235	36272	131	36558	95	37130	22
34650	235	36276	130	36562	96	37390	210
34654	235	36278	130	36564	96	37400	43
34656	235	36282	132, S23	36566	96	37410	43, S21, S23-S24
34658	236	36284	132	36568	96	37412	43
34660	236	36286	132	36572	95	37414	43
34664	236	36288	132	36574	95	37418	43
34666	236	36292	130	36576	96, S23	37420	129
34668	237	36294	130	36578	96	37425	150, S21, S23-S24
34672	237	36296	130	36582	96	37430	129, S21, S23
34674	237	36298	130	36584	96	37435	175, S21, S23-S24
34684	237	36302	130	36586	96, S24	37440	149
34686	238	36304	130	36588	96	37445	180
34688	238	36306	130, S21	36600	133	37450	172
34690	238	36308	130	36601	133	37500	175
34710	238	36312	132, S24	36604	97, 266	37503	175
34806	206, 227	36314	132	36655	133	37505	175
34810	223	36316	130	36680	133	37506	175
34811	223	36318	130	36690	133	37511	175, S21
34812	224, S17	36322	132, S24	36695	133	37512	175, S23
34814	224	36324	132	36700	133	37513	175, S24
		36326	131	36705	133	37515	175
<b>G-36...</b>		36328	131	36710	133	37525	175
		36332	130	36715	133	37530	175
36000	244-245, S21, S23-S24	36336	131	36720	133	37535	175
36010	244, 245	36342	132, S23	36740	133	37545	175
36015	244	36344	132	36755	133	37551	175, S21
36020	244	36356	130, S21	36765	133	37555	65
36025	244	36358	130	36900	97	37570	175
36030	244	36362	132, S23	36901	97	37602	184
36035	245	36364	132	36902	97	37604	184
36045	244	36366	132, S24	36915	97	37700	109
36050	245	36368	132	36925	97	37705	109
36065	245	36502	95	36930	97	37710	109

ITEM NO. ....	PAGE	ITEM NO. ....	PAGE	ITEM NO. ....	PAGE	ITEM NO. ....	PAGE
<b>G-38 ...</b>		39530 .....	261	42301 .....	222	<b>G-61 ...</b>	
38215 .....	86	39535 .....	261	42302 .....	222	61201 .....	220
38232 .....	86	39540 .....	262	42311 .....	221, S23	61202 .....	220
38236 .....	86	39541 .....	260	42319 .....	221	61204 .....	220
38238 .....	86	39542 .....	260	42321 .....	221	61205 .....	220
38240 .....	85, 116, S5	39543 .....	260	42322 .....	221	61231 .....	220
38242 .....	116	39545 .....	261	42323 .....	222	61232 .....	220
38244 .....	116, S5	39546 .....	261	42341 .....	219	61234 .....	220
38246 .....	85, S5	39547 .....	261	42342 .....	219	61235 .....	220
38341 .....	59	39548 .....	260	42343 .....	219	61251 .....	220
38342 .....	60	39549 .....	260	42344 .....	219, S23	61252 .....	220
38343 .....	59	39650 .....	257	42361 .....	218, S23	61254 .....	220
38344 .....	59	39680 .....	251	42362 .....	218	61255 .....	220
38444 .....	60	39741 .....	250	42501 .....	222		
38448 .....	60, S5	39745 .....	249	42502 .....	222	<b>G-80 ...</b>	
38453 .....	61	39746 .....	250	42511 .....	221	80975 .....	226
38466 .....	61	39750 .....	249, S2 - S3, S21, S23 - S24	42521 .....	221		
38473 .....	60	39753 .....	251	42522 .....	221		
38475 .....	59	39754 .....	251	42523 .....	222	<b>G-150 ...</b>	
38600 .....	41, S10 - S11	39755 .....	251	42541 .....	219	150001 .....	185
38601 .....	202, S10 - S11	39756 .....	251	42542 .....	219	150002 .....	185
38602 .....	202, S10 - S11	39762 .....	251	42544 .....	219, S24	150003 .....	185
38603 .....	118, S10	39764 .....	251	42561 .....	218, S24	150004 .....	185
38604 .....	168, S10	39782 .....	250, S2 - S3, S21, S23 - S24	42562 .....	218	150005 .....	185
38606 .....	118, 168, S10	39783 .....	249, 250, S2 - S3, S21, S23, S24	<b>G-46 ...</b>		150051 .....	185
38607 .....	168, S10 - S11	39784 .....	249	46001 .....	222	150052 .....	185
38608 .....	168, S10 - S11	39785 .....	249, 250	46002 .....	222	150053 .....	185
38620 .....	71, S11	39786 .....	249, S2 - S3, S21, S23 - S24	46011 .....	221	150054 .....	185
38621 .....	64, S11	39787 .....	250	46021 .....	221	150055 .....	185
38622 .....	168, S11	39788 .....	250	46022 .....	221	150101 .....	185, S17
38623 .....	105, S11	39789 .....	250	46023 .....	222	150102 .....	185, S17
38624 .....	117, S11	39791 .....	250	46041 .....	219, S21	150103 .....	185, S17
38628 .....	117			46042 .....	219	150104 .....	185
38630 .....	223	<b>G-40 ...</b>		46301 .....	222	150105 .....	185
38631 .....	203	40006 .....	218, S21, S23	46302 .....	222	150151 .....	185
38632 .....	203	40008 .....	218	46311 .....	221	150152 .....	185
38634 .....	117, S10 - S11	<b>G-42 ...</b>		46321 .....	221	150153 .....	185
38635 .....	223, S11	42001 .....	222	46322 .....	221	150154 .....	185
<b>G-39 ...</b>		42002 .....	222	46323 .....	222	150155 .....	185
39501 .....	261	42009 .....	222	46341 .....	219, S23	150301 .....	183
39502 .....	262	42011 .....	221, S21	46342 .....	219	150302 .....	183, S17
39503 .....	262	42019 .....	221	46343 .....	219, S23	150303 .....	183
39504 .....	262	42021 .....	221	46362 .....	218	150401 .....	183, S15, S17
39505 .....	263	42022 .....	221	46501 .....	222	150402 .....	183
39511 .....	261	42023 .....	222	46502 .....	222	150403 .....	183
39512 .....	262	42041 .....	219	46511 .....	221	<b>G-500 ...</b>	
39513 .....	262	42042 .....	219	46521 .....	221	500001 .....	215
39514 .....	262	42043 .....	219, S21	46522 .....	221		
39525 .....	259	42044 .....	219, S21	46523 .....	222	<b>G-520 ...</b>	
39526 .....	259, S4 - S5, S7, S12, S14 - S15	42061 .....	218, S21	46541 .....	219, S24	520400 .....	215
39527 .....	259			46542 .....	219, S24	520500 .....	215
39528 .....	259			46562 .....	218		

ITEM NO. .... PAGE      ITEM NO. .... PAGE

520550 .....	215	560625 .....	216
520600 .....	215	560650 .....	216
520625 .....	215	560675 .....	216
520650 .....	215	560700 .....	216
520675 .....	215	560725 .....	216
520700 .....	215	560750 .....	216
520725 .....	215	560775 .....	216
520750 .....	215	560800 .....	216, S9
520775 .....	215	560825 .....	216
520800 .....	215	560850 .....	216, S9
520825 .....	215	560875 .....	216
520850 .....	215	560900 .....	216
520875 .....	215	560925 .....	216
520900 .....	215	560950 .....	216
520950 .....	215		

**G-570...**

<b>G-521...</b>		570600 .....	216
521000 .....	215	570650 .....	216
521050 .....	215	570700 .....	216
521100 .....	215	570725 .....	216
521150 .....	215	570750 .....	216, S9
521200 .....	215	570775 .....	216
521250 .....	215	570800 .....	216, S9
521300 .....	215	570825 .....	216
521350 .....	215	570850 .....	216
521400 .....	215	570875 .....	216
521450 .....	215	570900 .....	216
521500 .....	215		
521550 .....	215		
521600 .....	215		
521650 .....	215		
521700 .....	215		
521800 .....	215		

**G-540...**

540600 .....	215
540625 .....	215
540650 .....	215
540675 .....	215
540700 .....	215
540725 .....	215
540750 .....	215
540775 .....	215
540800 .....	215
540825 .....	215
540850 .....	215
540875 .....	215
540900 .....	215
540925 .....	215
540950 .....	215

**G-560...**

560600 .....	216
--------------	-----

KEYWORD .....	PAGE	KEYWORD .....	PAGE	KEYWORD .....	PAGE
<b>A</b>					
Absorbent Swabs.....	231, S8, 231	Bone Gouge, West.....	243	Chopper, Tobias Neuhann.....	152
A.C. Infusion Cannula.....	S10	Bone Nibbling Rongeur.....	75, S17	Cilia And Foreign Body Forceps..	101, S13, S15
A.C. Infusion Cannula, Bopp.....	S10	Bone Nibbling Rongeur, Beyer.....	75	Cilia And Foreign Body Forceps, Hamburg	Model.....
Adapter.....	264	Bone Nibbling Rongeur, Citelli.....	75	Model.....	101
Anterior Chamber Forceps.....	121	Bone Nibbling Rongeur, Kerrison.....	75, S17	Cilia and Foreign Body Forceps, Shaaf.....	S13
Anterior Chamber Forceps,		Bonn Injection Set.....	238	Cilia And Foreign Body Forceps, Shaaf.....	101
von Barsewisch.....	121	<b>C</b>			
Anterior Chamber Infusion Cannula.....	191	Caliper.....	43, S2-S3, S12-S13, S16,	Cilia And Suture Forceps.....	101
Anterior Chamber Infusion Cannula,		.....	S18-S19, S21, S23-S24	Cilia And Suture Forceps, Barraquer.....	101
Bonn Model.....	191	Caliper, Castroviejo.....	43, S2-S3, S12-S13,	Cilia Forceps.....	101, S15
Anterior Chamber Infusion Cannula,		.....	S16, S18-S19, S21, S23-S24	Cilia Forceps, Barraquer.....	101
Bopp.....	191	Cannula.....	211	Cilia Forceps, Beer.....	101
Anterior Synechia Scissors.....	83	Cannula, Heidelberg Model.....	211	Cilia Forceps, Gradle.....	101
Anterior Synechia Scissors, Castroviejo.....	83	Capsule Forceps.....	S4	Cilia Forceps, Henry.....	101
Aspiration Adapter.....	264	Capsule Forceps, H.-R. Koch.....	S4	Clamp For Infusion Tube.....	27
Aspiration Cannula.....	193-196, 198, 210,	Capsule Polishing Cannula.....	195-196, 226,	Cleaning Adapter.....	97, 264-266
.....	S12, S21	.....	S2, S6	Clear-Cornea-Incision Fixation Ring.....	S3, S8
Aspiration Cannula, Brauweiler.....	196, 198	Capsule Polishing Cannula, Greite.....	196	Clear Cornea Knife.....	217
Aspiration Cannula Handpiece.....	198	Capsule Polishing Cannula, Kratz.....	195, S2	Colibri Forceps.....	104, S2-S4, S9, S13,
Aspiration Cannula Handpiece,		Capsule Polishing Cannula, Kyu.....	195	.....	S16, S19, S21, S23-S24
Brauweiler.....	198	Capsule Polishing Cannula, Papst.....	195	Combined Needle Holder / Scissors.....	88, 143
Aspiration Cannula, H.-R. Koch.....	196	Capsule Polishing Curette.....	160, S6	Conjunctiva Forceps.....	102, S16-S18,
Aspiration Cannula, Roeder.....	210	Capsule Polishing Curette, Rentsch.....	160, S6	.....	S21, S23-S24
Aspiration Cannula, Weber.....	210, S21	Capsule Scissors.....	85-86, S4-S5	Conjunctiva Forceps, Draeger... 102, S16-S18,	
Aspiration Handpiece.....	198-201, 227, S3, S5	Capsule Scissors, Brauweiler.....	85	.....	S21, S23-S24
Aspiration Handpiece, Brauweiler.....	200	Capsule Scissors, H.-R. Koch.....	85, S4	Conjunctiva Forceps, Foerster.....	102
Aspiration Handpiece,		Capsule Scissors, Osher.....	86	Conjunctiva Forceps, Freiburg Model.....	102
D.D. Koch - T. Kohnen.....	198	Capsule Scissors, Yae.....	85, S5	Conjunctiva Forceps, Kaufmann.....	102
Aspiration Handpiece, H.-R. Koch.....	200	Capsulorhexis Forceps.....	113-117, S2-S5	Conjunctiva Forceps, Krefeld Model.....	102
Aspiration Handpiece, Koch-Kohnen.....	S3, S5	Capsulorhexis Forceps, Hattenbach.....	117, S4	Corneal Irrigation Cannula.....	197, S10
Aspiration Handpiece, R. Koch.....	201	Capsulorhexis Forceps, H.-R. Koch.....	114	Corneal Irrigation Cannula, Krumeich.....	197, S10
Aspiration Handpiece, Schmack.....	198-199	Capsulorhexis Forceps, Ikeda.....	1166, S5	Corneal Marker.....	41-42, 45, 47, S7, S9-S11
Aspiration Polishing Cannula.....	195	Capsulorhexis Forceps, Masket.....	113	Corneal Marker, Hoffer.....	41
Aspiration Polishing Cannula, Teping.....	195	Capsulotomy Scissors.....	83-85, S2-S4,	Corneal Marker, Lindstrom.....	42
Aspiration Speculum.....	S7-S8	.....	S9-S10, S12-S13, S15, S21, S23-S24	Corneal Marker, Thomas Neuhann.....	41, S9-S11
Aspiration Speculum,		Capsulotomy Scissors,		Corneal Pendulum Marker.....	46, S6
Liebermann-Tennant.....	S7-S8	Tuebingen Model.....	84, S12	Corneal Pendulum Marker, Scott.....	46, S6
Aspiration Handpiece, Koch-Kohnen.....	S5	Capsulotomy Scissors, Vannas.....	84-85,	Corneal Punch.....	70, S9
<b>B</b>					
Backflush Cannula.....	207, 227-228,	.....	S2-S4, S9-S10, S13, S15, S21, S23-S24	Corneal Punch, Thomas Neuhann.....	70
.....	S21, S23-S24	Cerclage Forceps.....	127	Corneal Scarifier.....	64, 57, S9, S16
Backflush Cannula, Kampik.....	207	Cerclage Forceps, Essen Model.....	127	Corneal Scarifier, Kuhnt.....	64, S9, S14, S16
Backflush Cannula, Laqua.....	207	Chalazion Curette.....	51-52, S15-S16	Corneal Scissors.....	81-82, S2, S16, S18-S19
Backflush Handpiece.....	206, 227, S21, S23	Chalazion Curette, Axenfeld.....	52, S15	Corneal Scissors, Castroviejo.....	81
Backflush Tip.....	208, 209	Chalazion Curette, Hebra.....	52	Corneal Scissors, Katzin.....	81, S9-S10
Backflush Tip, Klein.....	208	Chalazion Curette, Meyhoeffer.....	51, S15-S16	Corneal Scissors, Sautter.....	81, 162, 192, 225,
Ball Capsule Polisher.....	160	Chalazion Curette, Meyhoeffer.....	S15	.....	S3-S5, S9, S12
Ball Capsule Polisher, Anis.....	160	Chalazion Forceps.....	134, S15	Corneal Scissors, Troutman.....	81, S2
Battery Cautery.....	246	Chalazion Forceps, Ayer.....	134	Corneal Section Scissors.....	82
Bone Chisel.....	243, S17	Chalazion Forceps, Cauer.....	134	Corneoscleral Punch.....	77
Bone Chisel, West.....	243	Chalazion Forceps, Desmarres.....	134, S16	Corneoscleral Punch, Gass.....	77
Bone Gouge.....	243	Chalazion Forceps, Lambert.....	134, S16	Crescent Knife.....	61
		Chalazion Forceps, Lordan.....	134, S15-S16	Crvo Knife.....	66
		Chalazion Knife.....	63	Crvo Knife, Dithmar.....	66
		Chopper.....	152	Cyclodialysis Spatula.....	164, 192
				Cyclodialysis Spatula Cannula.....	192
				Cyclodialysis Spatula Cannula, Busse.....	192
				Cyclodialysis Spatula, Castroviejo.....	164

KEYWORD .....	PAGE	KEYWORD .....	PAGE	KEYWORD .....	PAGE
Cyclodialysis Spatula, Elschmig.....	164	Duct Trephine.....	69, S12	Eye Speculum, Mellinger-Beard.....	20
<b>D</b>		Duct Trephine, Schmidt-Mumm.....	69, S12	Eye Speculum, Murdock.....	24-25
Dalk Probe.....	186	<b>E</b>		Eye Speculum, Noda.....	27-29
Dalk Probe, Krumeich.....	186	Elevatorium.....	242, S17	Eye Speculum, Ohno.....	17
DCR Lacrimal Intubation Set.....	224	Elevatorium, Heidelberg Model.....	242, S17	Eye Speculum, Paulmann.....	27
Degree Gauge.....	46	Enclavation Spatula.....	160	Eye Speculum, Pretori.....	21
Degree Gauge, Mendez.....	46	Enclavation Spatula, Sekundo.....	160	Eye Speculum, Sauer.....	19
Descemet Incision Hook.....	168, S10-S11	Endothelial Insertion Spatula.....	168	Eye Speculum, Schott.....	31-32
Descemet Membrane Forceps.....	117	Endothelial Insertion Spatula, Thomas Neuhann.....	168	Eye Speculum, Takeda.....	19
Descemet Membrane Forceps, Tobias Neuhann.....	117	Enucleation Scissors.....	94, S14	Eye Speculum, Thomas Neuhann.....	19
Descemet Punch.....	S12	Enucleation Spoon.....	167, S14	Eye Speculum, Weiss.....	21-22
Descemet Punch, Kelly.....	S12	Enucleation Spoon, Wells.....	167, S14	Eye Sphere.....	245, S14
Descemet Scraper.....	168, S10-S11	Enzyme Cannula.....	191	Eye Sphere, Cibis.....	245
Descemet's Membrane Punch.....	76	Ergoline Forceps.....	133	Eye Sphere, Harms.....	245
Descemet's Membrane Punch, Kelly.....	76	Ergoline Forceps ILM.....	133	Eye Sphere, Walser.....	245, S14
Diaclean CCI Diamond Knife.....	55	Ergoline Forceps ILM, Naito.....	133	<b>F</b>	
Diaclean Clear-Cornea-Incision		Ergoline Forceps, Tano.....	133	Fascia Needle.....	243
Diamond Knife, 1.5/2.0 mm.....	60	Ergoline Scissors.....	97	Fascia Needle, Wright.....	243
Diaclean Clear-Cornea-Incision		Ergoline Scissors, Heimann.....	97	Femtocataract Eye Speculum.....	26, S5
Diamond Knife, 2.2 mm.....	60	Ergoline Scissors, Kroll.....	97	Femtocataract Eye Speculum, Dick.....	26, S5
Diaclean Clear-Cornea-Incision		Ergoline Scissors, Naito.....	97	Femtocataract Eye Speculum, Solomon.....	26
Diamond Knife, 2.85 mm.....	61	Exenteration Curette.....	52, S14	Femtocataract Nucleus Rotator and Chopper.....	169, S5
Diaclean Diamond Crescent Knife.....	61	Exenteration Curette, Bunge.....	52, S14	Femtocataract Nucleus Rotator and Chopper, Hoffmann.....	169, S5
Diaclean Diamond Knife.....	59	Explantation Forceps.....	125, S4	Femtocataract Spatula.....	169, S5
Diaclean Tri-Facet Diamond Knife.....	60	Explantation Hook.....	157	Femtocataract Spatula, Breyer.....	169, S5
Diaclean Tri-Facet Diamond Knife, Pham.....	60	Explantation Hook, Tandogan.....	157	Femtocataract Spatula, Dick.....	169, S5
Diamond Burr.....	244, S14	Expressor Cannula.....	193	Femto Double Instrument.....	169, 170, S8
Diamond Knife.....	59- 62, S12	Expressor Cannula, Klöckner.....	193	Femto Double Instrument, Chansue.....	169, 170, S8
Diamond Micrometer Knife.....	62	Eye Douche.....	191, S3, S13	Femto Double Instrument, Guell.....	170
DMEK Graft Retainer.....	71, S11	Eye Douche, Cranz.....	191, S3, S13	Femto Flap Lifter.....	171
DMEK Graft Retainer, Szurman.....	71, S11	Eye Scissors.....	91-93, S2-S4, S9, S12, S14-S19, S21, S23-S24	Femto Flap Lifter, Pfaeffl.....	171
DMEK Irrigation Handpiece.....	203	Eye Scissors, Bonn Model.....	92, S2, -S4, S9, S12	Femto-LASIK Double-Ended Instrument.....	170, 172
DMEK Irrigation Handpiece, Szurman.....	203	Eye Scissors, Graefe.....	93	FemtoLASIK Double-Ended Instrument, Breyer.....	170
DMEK Keratoplasty Forceps.....	105, S11	Eyeshield.....	245	FemtoLASIK Double-Ended Instrument, Kohnen.....	172
DMEK Keratoplasty Forceps, Remky.....	105, S11	Eye Speculum.....	15-32, 223, S2-S5, S7-S10, S1-S15, S18-S19, S21, S23-S24	Femto-LASIK Flap Forceps.....	118, S8
DMEK Preparation Forceps.....	117, S11	Eye Speculum, Bangarter.....	23	Femto-LASIK Flap Forceps, Knorz.....	118, S8
DMEK Preparation Forceps, Szurman.....	117, S11	Eye Speculum, Barraquer.....	15-17, 19, S2-S4, S12-S13, S15	Femto-LASIK Hook.....	S8
DMEK Preparation Scraper.....	64, S11	Eye Speculum, Barraquer Frankfurt Model.....	16	Femto-LASIK Hook, Breyer.....	S8
DMEK Preparation Scraper, Szurman.....	64, S11	Eye Speculum, Barraquer-Oosterhuis.....	18	Femto-LASIK Hook Instrument.....	171
DMEK Preparation Spatula.....	168, S11	Eye Speculum, Bartl.....	22	FemtoLASIK Hook Instrument, Breyer.....	171
DMEK Preparation Spatula, Szurman.....	168, S11	Eye Speculum, Castroviejo.....	23	Femto-LASIK Round Spoon.....	170, S7
DMEK Transplant Forceps.....	117	Eye Speculum, Cook.....	23-24, S13-S14, S18	Femto-LASIK Round Spoon, Blum.....	S7
DMEK Transplant Forceps, Yörük.....	117	Eye Speculum, Cook.....	23-24, S13-S14, S18	FemtoLASIK Round Spoon, Blum.....	170
Dressing Forceps.....	110, S2, S9, S12-S15, S17-S19, S21, S23-S24	Eye Speculum, Kammann.....	29	Fixation And Holding Forceps.....	122
DSAEK/DMEK Rhexis Forceps.....	117, S10-S11	Eye Speculum, Kershner.....	25, S9, S14, S19, S21, S23-S24	Fixation And Holding Forceps, Dick.....	122
DSAEK/DMEK Rhexis Forceps, Gerten.....	117, S10-S11	Eye Speculum, Koga / Noda.....	28	Fixation Forceps.....	109, S14, S16
DSAEK Forceps.....	118, S10	Eye Speculum, Kratz-Barraquer.....	17, 19	Fixation Forceps, Barraquer.....	109, S14
DSAEK Forceps, Thomas Neuhann.....	118, S10	Eye Speculum, Liebermann-Tennant.....	25, 28, S2-S4, S7-S8, S10, S12-S13	Fixation Forceps, Barraquer.....	109, S14
DSAEK Implantation Forceps.....	118, S10	Eye Speculum, Mellinger.....	20	Fixation Forceps, Graefe.....	109, S14, S16
DSAEK Insertion Spatula.....	S10				
DSAEK Insertion Spatula, Thomas Neuhann.....	S10				

## KEYWORD ..... PAGE

Fixation Forceps, Heidelberg Model.....	109
Fixation, Holding and Measuring Instrument.....	150, S23-S24
Fixation Instrument.....	S21
Fixation Ring.....	149-150, S3, S8-S9
Fixation Ring, Fine-Thornton.....	149-150
Fixation Ring, Fine-Thornton.....	S7-S8
Fixation Ring, Thornton.....	149
Fixed Caliper.....	43
Fixed Caliper, Braunstein.....	43
Flap Forceps.....	S8
Flap Lifter.....	S7-S8
Flap Lifter, Pfaeffl.....	S7, S8
Flaporthesis Forceps.....	118, S7, S8
Flaporthesis Forceps, Pfaeffl.....	118, S7, S8
Folder.....	123, 124, S4
Folder, H.-R. Koch.....	124, S4
Folder, Spaleck.....	123
Forceps.....	128
Foreign Body Gouge.....	56
Foreign Body Instrument.....	55, S13, S15
Foreign Body Needle.....	56
Foreign Body Spud.....	56
Foreign Body Spud, Plange.....	56
Fragment Forceps.....	108, S4, S8
Fragment Forceps, Gaskin.....	108, S4
Fragment Forceps, Kelman-McPherson.....	108, S8

**G**

Glaucoma Punch.....	77, S12
Glaucoma Punch, Grehn.....	S12
Glaucoma Punch, Mohr.....	77
Globe Fixation Ring.....	149
Globe Fixation Ring, Hattenbach.....	149
Grooved Silicone Sponge Implant (506G Style).....	237
Grooved Silicone Sponge Implant (507G Style).....	237
Grooved Silicone Strip (31 Style).....	234
Grooved Silicone Strip (32 Style).....	234
Grooved Silicone Strip (219 Style).....	234

**H**

Hammer.....	242, S17
Hammer, Mead.....	242, S17
Handle.....	85, 89-94, 116, 218, S5
Handle, Japan Model.....	85, 116
Handle UNO Colorline.....	S21, S23
Handle UNO Colorline 20G, 23G, 25G.....	218
Handpiece For Capsule Scissors.....	86
Healon - Viscoelastic Cannula.....	193
Holder.....	186
Holder for Absorbent Strips.....	S7, S8
Holder For Absorbent Strips.....	145

## KEYWORD ..... PAGE

Holder, Thomas Neuhann.....	186
Holding Forceps.....	122, 124, 125, 127, S3
Holding Forceps, Pfennigwerth.....	127
Holding Forceps, Strobel.....	125
Horizontal Axis Marker.....	46, S6
Horizontal Axis Marker, Gerten.....	46, S6
Horseshoe-Hook.....	175, S21, S23-24
Horseshoe-Hook, Hattenbach.....	175, S21, S23-S24
Hybrid Combo Prechopper.....	120
Hybrid Combo Prechopper, Akahoshi.....	120
Hybrid Needle Holder.....	143, S4, S6
Hybrid Needle Holder, Hattenbach.....	143, S4, S6
Hybrid Scissors.....	86, S4, S6
Hybrid Scissors, Hattenbach.....	86, S4, S6
Hybrid Tying Forceps.....	108, S4, S6
Hybrid Tying Forceps, Hattenbach.....	108, S4, S6
Hydrodissection Cannula.....	192, 225, 217, S2-S5, S9, S12
Hydrodissection Cannula, Frankfurt Model.....	192, S2, S12-S13
Hydrodissection Cannula, Sautter.....	192, S2-S5, S9, S12
Hydrodissection Cannula, Spirig.....	192
Hydrodissection Cannula, Tuebingen Model.....	192

**I**

I/A Cannula, Simcoe.....	S2, S4
I/A Handpiece.....	203-205, 227
I/A Handpiece, Hunold.....	205
I/A Handpiece, Papst.....	205
ILM-Scraper.....	175, S21
ILM-Scraper, Bartz-Schmidt.....	175, S21
Implantation Forceps.....	118, 121-123, S2, S4
Implantation Forceps, Doden.....	121, S2, S4
Implantation Forceps, Fechner.....	121
Implantation Forceps, Sekundo.....	123
Implantation Forceps, Shepard.....	122
Implantation Forceps, T. Kohnen.....	122
Implantation Forceps, T. Neuhann.....	123
Implant Knife.....	S2
Incision Measuring Caliper.....	43
Incision Measuring Caliper, Osher.....	43
Indicator.....	255
Infusion Cannula.....	191, 209, 228, S10, S21
Infusion Sleeve.....	203-205
Injection Cannula.....	191, 193, 209-210, 226, 229
Injection Cannula, Duisburg Model.....	209, S21
Injection Cannula, Hamburg Model.....	210
Injector.....	241, S4
Intraocular Magnet.....	246, S21
Intraocular Magnet, Kuhn.....	246, S21

## KEYWORD ..... PAGE

IOL Forceps.....	125, S4, S6
IOL Forceps, Snyder-Osher.....	125, S4, S6
IOL Haptic Expander.....	122
IOL Haptic Expander, Dick.....	122
IOL Scissors.....	88
IOL Scissors.....	87-88, S4, S6
IOL Scissors, Snyder-Osher.....	88, S4, S6
IOL Scissors, Steinmetz.....	87, S4
Iris Forceps.....	110-112, S2, S12, S16, S19
Iris Forceps, Bonn Model.....	110-111, S2, S12
Iris Forceps, Elze.....	112
Iris Forceps, Hamburg Model.....	112
Iris Forceps, Heidelberg Model.....	111
Iris Forceps, Swiss Model.....	111-112
Iris Forceps, Thomas Neuhann.....	112
Iris Hook.....	154, 157-158, S2-S3
Iris Hook and Lens Manipulator.....	157-158
Iris Hook and Lens Manipulator, Dardenne.....	157
Iris Hook and Lens Manipulator, Frankfurt Model.....	158
Iris Hook and Nucleus Dividing Hook.....	154
Iris Hook and Nucleus Dividing Hook, Thomas Neuhann.....	154, S3
Iris Hook and Nucleus Dividing Hook, T. Kohnen.....	154
Iris Hook, Bonn Model.....	158
Iris Hook, Dardenne.....	S2
Iris Hook, Lund.....	158
Iris Scissors.....	86-87
Iris Scissors, Barraquer.....	87
Iris Scissors, Noyes.....	86
Iris Scissors, Wecker.....	86-87
Iris Spatula.....	165-166
Iris Spatula, Bangerter.....	166
Iris Spatula, Frankfurt Model.....	165
Iris Spatula, Wecker.....	165
Irrigating Chopper, Dick.....	202
Irrigation / Aspiration Cannula.....	194-195
Irrigation / Aspiration Cannula Coaxial.....	195
Irrigation / Aspiration Cannula, Simcoe.....	194
Irrigation Cannula.....	194, 196-198, 226, S7, S10, S12
Irrigation Cannula, Binkhorst.....	194
Irrigation Cannula, Bonn Model.....	194, S15
Irrigation Cannula, Brauweiler.....	196, 198
Irrigation Cannula Handpiece.....	197-198
Irrigation Cannula Handpiece, Brauweiler.....	198
Irrigation Cannula Handpiece, Keerl.....	198
Irrigation Cannula, Mueller.....	194
Irrigation Cannula, Rentsch.....	194
Irrigation Chopper.....	202
Irrigation Chopper, R. Koch.....	202
Irrigation Cystotome Cannula.....	191
Irrigation Descemet Hook.....	202, S11
Irrigation Descemet Hook.....	

KEYWORD .....	PAGE	KEYWORD .....	PAGE	KEYWORD .....	PAGE
Althaus/Cartsburg.....	202, S10-S11	Lacrimal Probe, Wilder.....	183, S15, S17	Lens Loop, Snellen.....	161
Irrigation Descemet Scraper.....	202, S10-S11	Lacrimal Sac Retractor.....	37-38, S16-S17	Lens Loop, Spirig.....	161
Irrigation Descemet Scraper,		Lacrimal Sac Retractor, American Model.....	38	Lens Loop, Weber.....	161
Neuhann.....	202, S10-S11	Lacrimal Sac Retractor, Axenfeld. 37, S16-S17		Lens, Machemer.....	244
Irrigation Handpiece.....	198-201, 203, 227,	Lacrimal Sac Retractor, Goldstein.....	38	Lens Manipulation Hook.....	156, S2-S4
.....	S3, S5	Lacrimal Sac Retractor, Mueller.....	38	Lens Manipulation Hook, Sinskey..	156, S2-S4
Irrigation Handpiece, Brauweiler.....	201	Lacrimal Sac Retractor, Rollet.....	37	Lens Manipulator.....	155-158
Irrigation Handpiece,		Lasek Epi Peeler.....	64	Lens Manipulator and Hook.....	156
D.D. Koch - T. Kohnen.....	199	Lasek Epi Peeler, Lohmann.....	64	Lens Manipulator and Hook, Rentsch.....	156
Irrigation Handpiece, Koch-Kohnen.....	S3, S5	LASEK Epi Peeler, Lohmann.....	S7	Lens Manipulator, Bremen Model.....	156
Irrigation Handpiece, Schmack.....	198	LASEK Funnel.....	243, S7	Lens Manipulator, Jacobi.....	156
Irrigation Trabeculotomy Cannula.....	193	LASEK Funnel, Lohmann.....	243, S7	Lens Manipulator, Mainz Model.....	155
Irrigation Trabeculotomy Cannula, Burk.....	193	LASEK Spatula.....	168	Lens, Peyman.....	244
Irrigation Vectis Cannula.....	193, 226, S2	LASEK Trephine.....	243, S7	Lens Spatula.....	157
<b>J</b>		LASIK Cannula.....	196, S7	Lens Spatula, Hirschmann.....	157
Jewelers Type Forceps.....	109	LASIK Cannula, Bauer.....	S7	Lens, Tolentino.....	244
<b>K</b>		LASIK Cannula, W. Bauer.....	196	Lenticule Forceps.....	119, S8
Karate Phaco Chopper.....	152	LASIK Corneal Flap Forceps.....	119	Lenticule Forceps, Rupal Shah.....	119
Karate Phaco Chopper, Agarwal.....	152	LASIK Corneal Flap Forceps, Buratto.....	119	Lenticule Micro Forceps.....	S8
Keratome.....	63	Lasik Corneal Marker.....	45, S7	Lenticule Micro Forceps, Rupal Shah.....	S8
Keratome, Hamburg Model.....	63	LASIK Corneal Marker.....	S7	Lid Plate.....	36, S15-S16
Keratometer.....	45, S9	Lasik Corneal Marker, Chayet.....	45	Lid Plate, Jaeger.....	36, S15-S16
Keratometer, Maloney.....	45, S9	LASIK Corneal Marker, Chayet.....	S7	Lid Retractor.....	35-36, S13-S16, S18
Keratoplasty Forceps.....	104-105, S9	Lasik Corneal Marker, Lu.....	45	Lid Retractor, Desmarres.....	35-36,
Keratoplasty Forceps, Remky.....	105	LASIK Corneal Marker, Lu.....	S7	.....	S13-S16, S18
Keratoplasty Forceps,		Lasik Corneal Marker, Mendez.....	45	Lid Retractor, Giessen Model.....	36
Thomas Neuhann.....	104, S9	LASIK Corneal Marker, Mendez.....	S7	Lid Retractor, Giessen Model.....	36
Keratoplasty Knife.....	64, S9	LASIK Corneal Protector.....	167, S7-S8	Limbal Relaxing Incision Diamond Knife.....	61
Keratoplasty Knife, Paufigue.....	64, S9	LASIK Corneal Protector, Zirm.....	167, S7-S8	Localizer and Scleral Depressor.....	180
Keratoplasty Scissors.....	81-82, S9-S10	LASIK Dissector Cannula.....	197, S7-S8	Localizer and Scleral Depressor,	
Keratoplasty Scissors, Katzin.....	S9-S10	LASIK Dissector Cannula, Zirm.....	197, S7-S8	Meyer-Schwickerath.....	180
Keratoplasty Scissors, Mackensen.....	82	Lasik Eye Speculum.....	26, 30	<b>M</b>	
Keratoplasty Spatula.....	163, S9	LASIK Eye Speculum.....	S7	Manipulator.....	154-158
Keratoplasty Trephine.....	69-70	Lasik Eye Speculum, Knorz.....	26	Manipulator, Frankfurt Model.....	156
Keratoplasty Trephine, Best.....	69	LASIK Eye Speculum, Knorz.....	S7	Manipulator, Mainz Model.....	155
Keratoplasty Trephine, Franceschetti.....	69	Lasik Eye Speculum, Maus.....	30	Marker.....	S7, S12, S18
Keratoplasty Trephine, Hamburg Model.....	69	LASIK Eye Speculum, Zirm.....	30	Marker, Fink.....	S18
<b>L</b>		LASIK Flap Forceps.....	S7, S8	Marker, Fronimopoulos.....	S12
Lacrimal Cannula. 189-190, 224, S3, S13, S17		LASIK Flap Forceps, Buratto.....	S7, S8	Marking Instrument.....	S21, S23-S24
Lacrimal Cannula, Anel.....	189, S17	LASIK Irrigation Cannula.....	197, S7	Marking Pen.....	231, S6-S7, S16, 231
Lacrimal Cannula, Bonn Model.....	190	LASIK Irrigation Cannula, Zirm.....	197, S7	Measuring Spatula.....	44
Lacrimal Intubation Set.....	223-224, S17	LASIK Spatula.....	167, S8	Measuring Spatula, Engels.....	44
Lacrimal Intubation Tubing.....	223	LASIK Spatula, Neuhann.....	S7	Melag Metal Grid Insert.....	263
Lacrimal Probe... 183, 185-186, 190, S15, S17		LASIK Spatula, Rau.....	168	Membrane Peeler.....	175, S21, S23-S24
Lacrimal Probe, Bowman.....	185, S17	LASIK Spatula, Thomas Neuhann.....	167	Membrane Peeler, Morris-Kroll.....	175
Lacrimal Probe Cannula.....	190, S17	Lens.....	88, 244, 245, S2, S4, S21, S23, S24	Membrane Spatula, Lucke.....	175, 179
Lacrimal Probe Cannula, Bangerter.....	190	Lens Extraction Hook.....	155	Meridional Silicone Implant (106 Style).....	235
Lacrimal Probe Cannula, Juenemann. 190, S17		Lens Extraction Hook, Hennig / Friedrich... 155		Metal Stand.....	72
Lacrimal Probe, Giessen Model.....	183, S17	Lens Handle Ring.....	245	Micro Colibri Forceps.....	104, S2-S3, S9,
Lacrimal Probe, Juenemann.....	186, 190, S17	Lens, Kilp.....	244, S21, S23-S24	.....	S16, S21, S23-S24
		Lens, Landers.....	244	Microfinger.....	154
		Lens Loop.....	157, 161, S2	Microfinger, Liebermann.....	154
		Lens Loop, Arlt.....	161, S2, S4	Micro Forceps.....	116, S8
		Lens Loop Manipulator.....	157	Micro Forceps, Tobias Neuhann.....	116
		Lens Loop Manipulator, Lester.....	157	Micro Round Knife.....	63, S12
		Lens Loop Manipulator, Zirm.....	157		

KEYWORD ..... PAGE

Micro Stitch Scissors..... 82  
 MICROSTO Container high..... S21, S23-S24  
 MICROSTOP Clip for Retainer Elements..... 250  
 MICROSTOP Container high..... 249  
 MICROSTOP Container High..... S2-S3  
 MICROSTOP Container low..... 249  
 MICROSTOP ID Label..... 250  
 MICROSTOP Label..... 250  
 MICROSTOP Logistic Frame..... 251  
 MICROSTOP Retainer Element..... 250, S2-S3,  
 ..... S21, S23-S24  
 MICROSTOP Seal..... 251  
 MICROSTOP Tag..... 251  
 MICROSTOP Tray Lid mini..... 250  
 MICROSTOP Tray mini..... 249, S2-S3, S21,  
 ..... S23-S24  
 Micro Trabeculectomy Punch..... 76  
 Micro Trabeculectomy Punch, Grehn..... 76  
 MICS Capsule Forceps..... 115-116  
 MICS Capsule Forceps, H.-R. Koch..... 115-116  
 MICS Capsulorhexis Forceps..... 115-116, S5  
 MICS Capsulorhexis Forceps, Auffarth..... S5  
 MICS Capsulorhexis Forceps, Ikeda..... 116  
 MICS Capsulorhexis Forceps, Inamura..... 115  
 MICS Capsulorhexis Forceps, Kampik..... 115  
 MICS Double Cross Action  
 Capsulorhexis Forceps..... 115, S3  
 MICS Double Cross Action  
 Capsulorhexis Forceps, Auffarth..... 115, S3  
 Mosquito Forceps..... 135, S2, S9, S12-S14,  
 ..... S16-S19, S21, S23-S24  
 Mosquito Forceps, Halstead..... 135, S2, S9,  
 ..... S12-S14, S17-S19, S21, S23-S24  
 Mosquito Forceps, Hartmann..... 135, S16,  
 ..... S21, S23-S24  
 Muscle Forceps..... 126-127, S14, S18-S19  
 Muscle Forceps, Bangerter..... 126, S14, S18  
 Muscle Forceps, Sattler..... 127, S18-S19

**N**

NanOEdge Crescent Knife..... 217  
 NanOEdge Implant Knife..... 217, S2  
 NanOEdge MVR Stilet..... 217  
 NanOEdge MVR Stiletto..... S21  
 NanOEdge Paracentesis Knife..... S2-S3,  
 ..... S12-S13, S16, S19  
 NanOEdge Phaco Slit Knife..... 217, S3  
 NanOEdge Single-Use Clear Cornea  
 Knife..... 217  
 NanOEdge Single-Use Corneal  
 Cutting Block..... 215  
 NanOEdge Single-Use Knives..... 217  
 NanOEdge Single-Use Paracentesis Knives 217  
 NanOEdge Spoon Knife..... 217  
 NanOEdge Trephine Punches..... 215

KEYWORD ..... PAGE

NanOEdge Trephines..... 215  
 NanOEdge Vacuum Corneal Punch..... S9  
 NanOEdge Vacuum Trephine..... 216, S9  
 NanOEdge Vacuum Trephine Punches..... 216  
 NanOEdge Vacuum Trephine radial..... 216  
 Nasal Forceps..... 127  
 Nasal Forceps, Troeltsch..... 127  
 Nasal Speculum..... 242, S17  
 Needle Holder..... 88, 139-144, S2-S4,  
 ..... S9-S10, S12-S19, S21, S23-S24  
 Needle Holder, Arruga..... 144  
 Needle Holder, Barraquer..... 139-141, S2-S4,  
 ..... S9-S10, S12-S13, S19  
 Needle Holder, Barraquer-Troutman..... 140  
 Needle Holder, Boynton..... 144  
 Needle Holder, Castroviejo..... 142, S2,  
 ..... S12-S19, S21, S23-S24  
 Needle Holder, Heidelberg Model..... 144  
 Needle Holder, Jacobi..... 139, S9  
 Needle Holder, Kalt..... 143  
 Nucleus Dividing Hook..... 151-154, S3, S5  
 Nucleus Dividing Hook, Haefliger..... 152  
 Nucleus Dividing Hook, Miyoshi..... 151  
 Nucleus Dividing Hook, Nagahara..... 152-153,  
 ..... S3, S5  
 Nucleus Dividing Hook,  
 Thomas Neuhann..... 151, S5  
 Nucleus Dividing Hook, Völcker..... 151  
 Nucleus Dividing Hook, Zirm..... 151  
 Nucleus Manipulator and Anterior  
 Capsule Polisher..... 155  
 Nucleus Manipulator and Anterior  
 Capsule Polisher, Drysdale..... 155  
 Nucleus Rotator..... 153, 155, 169  
 Nucleus Rotator and Chopper..... 153  
 Nucleus Rotator and Dividing Hook..... 153  
 Nucleus Rotator and Dividing Hook,  
 Thomas Neuhann..... 153  
 Nucleus Rotator, Thomas Neuhann..... 153, 155  
 Nucleus Rotator, Thomas Neuhann  
 and Chopper, Tobias Neuhann..... 153  
 Nucleus Spreading Forceps..... 120  
 Nucleus Spreading Forceps, Akahoshi..... 120  
 Nucleus Sustainer..... 154  
 Nucleus Sustainer, Akahoshi..... 154

**O**

Oculopressor..... 48  
 Oculopressor, Homburg Model..... 48  
 Operating Scissors..... 94  
 Orbital Spatula... 162-163, S19, S21, S23-S24  
 Orbital Spatula, Behrens-Baumann..... 162  
 Orbital Spatula, Hamburg Model..... 162, S19  
 Orbital Spatula, Sautter..... 162  
 Oval Silicone Sleeve (3083 Style)..... 235

KEYWORD ..... PAGE

Oval Silicone Sleeve (3084 Style)..... 235  
 Oval Silicone Sponge Implant (501 Style)..... 236  
 Oval Silicone Sponge Implant (506 Style)..... 236  
 Oval Silicone Sponge Implant (507 Style)..... 237

**P**

Paracentesis Knives..... 217  
 Pendulum Instrument..... 47  
 PEP 2.2 mm I/A Handpiece..... 203  
 PEP 2.2 mm Infusion Sleeve..... 203  
 PEP 2.4 mm I/A Handpiece..... 204  
 PEP 2.4 mm Infusion Sleeve..... 204  
 Permanent Textile Filter..... 255  
 PFCL Cannula..... 210, 228, S23  
 PFCL Cannula, Chang..... 210  
 Phaco Spatula..... 159  
 Phaco Spatula, Amon..... 159  
 Phaco Spatula, D. D. Koch..... 159  
 Phaco Spoon..... 159  
 Phaco Spoon, Engels..... 159  
 Pigtail Probe..... 184, S17  
 Prechopper..... 120, S3  
 Prechopper, Akahoshi..... 120, S3  
 Prefolder..... 124  
 Prefolder, H.-R. Koch..... S4  
 Pressure Tube..... 211  
 Probe for Stromal Channel..... 184  
 Protocol Cards..... 251  
 Ptosis Forceps..... 134, S16  
 Ptosis Forceps, Berke..... 134, S16  
 Punch..... S9, S12

**R**

Raspatory..... 242, S17  
 Raspatory, Heidelberg Model..... 242, S17  
 Razor Blade Holder..... 145  
 Razor Blade Holder, Barraquer..... 145  
 Razor Blade Holder, Castroviejo..... 145  
 Razor Blade Holder, Troutman..... 145  
 Razor Blades..... 145  
 Retainer For Pendulum Instrument..... 47  
 Retina Diamond Knife..... 62  
 Retinal Tack..... 128  
 Retinal Tack, Heimann..... 128  
 Retractor..... 38, S2, S4, S13-S18  
 Retractor, Guthrie..... 38, S16  
 Retrobulbar Injection Cannula..... 191  
 Retrograde Probe..... 184  
 Retrograde Probe, Kellnar..... 184  
 Rongeur..... 75, 242, S17  
 Rongeur, Friedmann..... 242, S17  
 Round Silicone Sponge Implant (503 Style)..... 235  
 Round Silicone Sponge Implant  
 (504 Style)..... 236



KEYWORD .....	PAGE	KEYWORD .....	PAGE	KEYWORD .....	PAGE
Round Silicone Sponge Implant (505 Style).....	236	Silicone Chamber .....	206, 227	Sautter.....	225, S5
Ruler.....	44, S19	Silicone Circling Band (40 Style).....	233	Single-Use Hydrodissection Cannula, Tuebingen Model .....	225
Ruler, Giessen Model.....	44	Silicone Circling Band (240 Style).....	233	Single-Use I/A Cannula.....	226
<b>S</b>		Silicone Closure .....	258	Single-Use I/A Cannula, Simcoe.....	226
Safety Seal.....	258	Silicone Insert.....	72	Single-Use Infusion Cannula.....	228
Sato Knife.....	65	Silicone Lens Bi-Sector.....	88, S4	Single-Use Infusion Tube 20G UNO Colorline.....	222
Sato Knife, Dardenne.....	65	Silicone Lens Bi-Sector, H.-R. Koch.....	88, S4	Single-Use Injection Cannula.....	226, 229
Sato Knife, Foerster.....	65	Silicone Nap Strip blue.....	257	Single-Use Injection Cannula, Kirchhof.....	229
Sato Knife, Hansen.....	65	Silicone Perforated Tray.....	256	Single-Use Iris Retractor.....	223, S2, S4
Scalpel Handle.....	231, S14-S15	Silicone Plate.....	257	Single-Use Irrigation Cannula.....	226
Scalpel Surgical Blades.....	231, S14-S15	Silicone Replacement Ring.....	244-245	Single-Use Irrigation Vectis Cannula.....	226
Scissors.....	218, 143, S2-S6, S9-S10, S12-S14, S16-S19, S21, S23-S24	Silicone Sleeve (70 Style).....	234	Single-Use Knives.....	217
Scissors, Barraquer.....	S12	Silicone Sleeve (72 Style).....	234	Single-Use Lacrimal Cannula.....	224, S17
Scissors, Westcott...89, S2, S9, S12-S13, S16, S18-S19, S21, S23-S24		Silicone Sleeve (270 Style).....	234	Single-Use Mini Filter.....	229
Scleral Depressor.....	179-180, S15, S19	Silicone Strip (41 Style).....	233	Single-Use Oil Injection System.....	230
Scleral Depressor, Kreissig.....	179	Silicone Strip (42 Style).....	233	Single-Use Peribulbar Cannula.....	224
Scleral Depressor, Laqua.....	179, S19	Silicone Strip blue.....	257	Single-Use PFCL Cannula.....	228, S23
Scleral Depressor, Lucke.....	179	Silicone Tire (276 Style).....	232	Single-Use Pressure Tube.....	229
Scleral Depressor, Schocket.....	180	Silicone Tire (277 Style).....	232	Single-Use Retrobulbar Cannula.....	224, S3
Scleral Fixation Ring.....	150	Silicone Tire (279 Style).....	232	Single-Use Retrobulbar Cannula, Atkinson.....	224, S3
Scleral Fixation Ring, Flieringa.....	150	Silicone Tire (287 Style).....	232	Single-Use Silicone Chamber.....	227
Scleral Flap Marker.....	44, S12	Silicone Tray.....	256	Single-Use Syringe.....	229
Scleral Flap Marker, Tobias Neuhann...44, S12		Silicone Wedge (137 Style).....	235	Single-Use Tano Forceps.....	S24
Scleral Knife.....	63	Single-Use A. C. Cannula.....	225	Single-Use Tano Forceps UNO Colorline.....	219
Scleral Knife, Bonn Model.....	63	Single-Use A. C. Cannula, Rycroft.....	225	Single-Use Three-Way Stop Cock.....	231
Scleral Plug.....	128, S21	Single-Use A. C. Maintainer.....	225	Single-Use Trocar Plugs UNO Colorline.....	221
Scleral Plug Forceps.....	128	Single-Use A. C. Maintainer, Lewicky.....	225	Single-Use Trocar System One-Step UNO Colorline.....	221
Scleral Ruler.....	44, S18	Single-Use Backflush Cannula.....	S24	Single-Use Trocar System One-Step UNO Colorline.....	221
Scleral Ruler, Vogt.....	44, S18	Single-Use Backflush Cannula.....	227-228, S21, S23-S24	Single-Use Vitreous Forceps Crocodile Design.....	219, S21, S23
Seal.....	258	Single-Use Backflush Handpiece.....	227	Single-Use Vitreous Forceps Endgripping.....	219, S23-S24
Seal / Label.....	261	Single-Use Bimanual I/A Handpiece Set.....	227	Single-Use Vitreous Forceps Wave Design UNO Colorline.....	219
Security Seal.....	262	Single Use Cannula.....	228, S23	Single-Use Vitreous Forceps Wave Design UNO Colorline, Hattenbach.....	219
Semi-Circular Silicone Sponge Implant (510 Style).....	237	Single-Use Capsule Polishing Cannula.....	226	Single-Use Vitreous Scissors UNO Colorline.....	218, S24
Semi-Oval Silicone Sponge Implant (511 Style).....	238	Single-Use Capsule Polishing Cannula, Kratz.....	226	Spare Silicone Tube.....	210
Semi-Oval Silicone Sponge Implant (515 Style).....	238	Single-Use Cystotome Cannula.....	224, S2	Spare Tip.....	246
Semi-Oval Silicone Sponge Implant (517 Style).....	238	Single-Use DMEK Cartridge.....	S11	Spare Tubing Set.....	26
Serrefine.....	136, S2, S18-S19, S21, S23-S24	Single-Use DMEK-Cartridge.....	223	Spatula.....	44, 153, 158-159, 162-163, 166-167, 192, S2-S3, S5, S7, S10, S12, S19, S21, S23-S24
Serrefine, Dieffenbach.....	136, S2, S18-S19, S21, S23-S24	Single-Use DMEK Cartridge, Szurman.....	S11	Spatula and Dividing Hook, Thomas Neuhann.....	153
Silicone Ball.....	48	Single-Use DMEK-Cartridge, Szurman.....	223	Spatula and Nucleus Dividing Hook.....	153
Silicone Block.....	71	Single-Use Endo-Probe C UNO Colorline.....	220	Spatula and Retractor.....	167
Silicone Block for DMEK.....	71	Single-Use Endo-Probe S UNO Colorline.....	220	Spatula and Retractor, Giessen Model.....	167
Silicone Block for DMEK, Örk Linz Model.....	71	Single-Use Endo-Probe W UNO Colorline.....	221	Spatula, Bangerter.....	162, S19
Silicone Block With Center Point.....	71	Single-Use Eye Speculum.....	223	Spatula, Essen Model.....	166
Silicone Bulb.....	212	Single-Use Fiber Optic S UNO Colorline.....	221		
Silicone Bulb.....	S15	Single-Use Fiber Optic WS UNO Colorline.....	222		
Silicone Burl Mat.....	257, 262	Single-Use Fiber Optic W UNO Colorline.....	221		
		Single-Use Forceps, Tano.....	S24		
		Single-Use High Speed Vitreous Cutter MACH 2 UNO Colorline.....	222		
		Single-Use High Speed Vitreous Cutter UNO Colorline.....	222		
		Single-Use Hydrodissection Cannula.....	225, S5		
		Single-Use Hydrodissection Cannula, Frankfurt Model.....	225		
		Single-Use Hydrodissection Cannula,			

KEYWORD ..... PAGE

Spatula, Rentsch..... 159, S10  
 Spatula, Spirig..... 158  
 Spatula, Steinmetz..... 158  
 Spatula, Thomas Neuhann and Nucleus Dividing Hook, Nagahara..... 153  
 Speculum..... S2 -S3, S7 -S8, S14, S23 -S24  
 Spreading Forceps..... 120, 127, S19  
 Spreading Forceps, Watzke..... 127, S19  
 Sterilization Case..... 252 -255, 257 -259  
 Sterilization Rack..... 256  
 Sterisafe Duro A4..... 259  
 Sterisafe Duro A4 Plus..... 259  
 Sterisafe Duro A4 Plus Complete Set..... 259, S4 -S5, S7, S12, S14 -S15  
 Sterisafe Duro A6..... 259  
 Sterisafe Duro Metal Tray A4-15..... 260  
 Sterisafe Duro Metal Tray A4-30..... 260  
 Sterisafe Duro Metal Tray A6-15..... 260  
 Sterisafe Duro Wire Basket A4-30..... 260  
 Sterisafe Duro Wire Basket A6-30..... 260  
 Sterisafe Filter..... 261  
 Sterisafe Filter Tag Expiration Date..... 261  
 Sterisafe Metal Grid Insert..... 262 -263  
 Sterisafe Silicone Burl Mat..... 262  
 Sterisafe Silicone Grid Insert..... 262  
 Sterisafe Silicone Retainer Strip 75..... 261  
 Sterisafe Silicone Retainer Strip 145..... 261  
 Sterisafe Silicone Retainer Strip 230..... 261  
 Stiletto..... 64  
 Stitch Scissors..... 82, 92  
 Stitch Scissors, Spencer..... 92  
 Stopper..... 211  
 Strabismus Hook..... 173 -174, S13 -S16, S18 -S19, S21, S23 -S24  
 Strabismus Hook, Bonn Model..... 174, S13, S19, S21, S23 -S24  
 Strabismus Hook, Graefe..... 173, S13 -S14, S16, S18 -S19  
 Strabismus Hook, Hamburg Model..... 173  
 Strabismus Hook, Jameson..... 174, S13, S15, S21, S23 -S24  
 Strabismus Hook, Malbran..... 174, S18 -S19  
 Strabismus Marker..... 44  
 Strabismus Marker, Fink..... 44  
 Strabismus Muscle Tucker..... 42, 172, S18  
 Strabismus Muscle Tucker, Cueppers..... 42, 172, S18  
 Strabismus Scissors..... 90 -91, S15  
 Strabismus Scissors, Bonn Model..... 90  
 Sub-Tenon Injection Cannula..... 193  
 Sub-Tenon Injection Cannula, Nagata..... 193  
 Superior Rectus Forceps..... 125 -126, S2, S12, S19  
 Superior Rectus Forceps, Castroviejo..... 126  
 Superior Rectus Forceps, Elschmig..... 126  
 Superior Rectus Forceps, Leydhecker..... 126

KEYWORD ..... PAGE

Superior Rectus Forceps, Remky..... 125, S2, S12, S19  
 Suture Hook..... 172, S17  
 Suture Hook, Muenster Model..... 172, S17  
 Suture Marker..... 42, S9  
 Suture Marker, Duncker..... 42, S9  
 Suture Marker, Thomas Neuhann..... 42  
 Suture Removing Forceps..... 104, S15  
 Suture Removing Forceps, Barraquer..... 104  
 Suture Tool..... 172  
 Suture Tool, Bonn Model..... 172  
 Suturing Forceps..... 103 -105, S3, S9, S13 -S14, S16 -S19, S21, S23 -S24  
 Suturing Forceps, Castroviejo..... 103, S3, S9, S13, S16, S18 -S19, S21, S23 -S24  
 Suturing Forceps, Munich Model..... 103  
 Suturing Forceps, Zuerich Model..... 104  
 Synechiae Spatula..... 163  
 Synechiae Spatula, Binkhorst..... 163  
 Synechiae Spatula, Castroviejo..... 163  
 Syringe Clip..... 212  
 Syringe Holder..... 211

**T**

Temporal Approach Eye Speculum..... 17  
 Temporal Approach Eye Speculum, H.-R. Koch..... 17  
 Tenotomy Scissors..... 89, 90, S3, S13 -S14, S16 -S19, S21, S23 -S24  
 Tenotomy Scissors, Bonn Model..... 90  
 Tenotomy Scissors, Stevens..... 89, S3, S13 -S14, S16 -S19, S21, S23 -S24  
 Tissue Forceps..... 110  
 Tomark Adjustable Corneal Marker..... 47  
 TOMARK Adjustable Corneal Marker..... 56  
 TOMARK Pendulum Instrument..... 47, 56  
 Tonometer..... 48, S12  
 Tonometer, Schioetz..... 48, S12  
 Towel Forceps..... 136, S12, S19, S21, S23 -S24  
 Towel Forceps, Backhaus..... 136  
 Towel Forceps, Schaedel..... 136, S12, S19, S21, S23 -S24  
 Trabecular Aspiration Cannula..... 512  
 Trabecular Aspiration Cannula, Ph. Jacobi..... 512  
 Trabecular Probe..... 186, S12  
 Trabecular Probe, Harms..... 186, S12  
 Trabecular Probe, Mackensen..... 186  
 Trabeculectomy Marker..... 44  
 Trabeculectomy Marker, Fronimopoulos..... 44  
 Trabeculectomy Punch..... 76, S12  
 Trabeculectomy Punch, Luntz-Dodick..... 76, S12  
 Trabeculum Scissors..... 83  
 Trephine..... 69 -70, 215 -216, 243, 57  
 Trephine, Best..... 69  
 Triangle Scleral Depressor..... 180

KEYWORD ..... PAGE

Triangle Scleral Depressor, Hattenbach..... 180  
 Tri-Facet Diamond Step Knife..... 61, S12  
 Trocar Closure Forceps..... 129  
 Trocar Closure Forceps, Bartz-Schmidt..... 129  
 Trocar Forceps..... 129, S21, S23  
 Tying Forceps..... 105 -108, S2 -S4, S9 -S10, S12 -S13, S16 -S19, S21, S23 -S24  
 Tying Forceps, Bangerter..... 107  
 Tying Forceps, Bonn Model..... 106  
 Tying Forceps, Dardenne..... 107  
 Tying Forceps, Paufigue..... 105  
 Tying Forceps, Tuebingen..... 59  
 Tying Forceps, Tuebingen Model..... 106, S2 -S3, S10, S12 -S13, S16 -S19, S21, S23 -S24

**U**

Universal Prechopper..... 121  
 Universal Prechopper, Akahoshi..... 121  
 Universal Prefolder, H.-R. Koch..... 124  
 Universal Suturing Forceps..... 105, S14, S17, S21, S23 -S24  
 Universal Suturing Forceps, Paufigue..... 105, S14, S17, S21, S23 -S24  
 UNO Colorline Forceps..... 219, S21, S23 -S24  
 UNO Colorline Forceps, Tano..... 219, S21  
 UNO Colorline Single-Use Instruments..... 218 -222  
 UNO Colorline Trocar System..... 223, S21, S23  
 UNO Colorline Trocar System, Hattenbach / Nikolic..... S21, S23  
 UNO Colorline Vitreous Forceps..... 219, S24  
 UNO Colorline Vitreous Forceps Crocodile Design..... 219, S21, S23  
 UNO Colorline Vitreous Forceps, Hattenbach..... 219, S24  
 UNO Colorline Vitreous Scissors..... 218, S21, S23, S24  
 U-Shaped Probe..... 186  
 U-Shaped Probe, Thomas Neuhann..... 186

**V**

Visual Axis Marker..... 45  
 Visual Axis Marker, Grene..... 45  
 Vitreoretinal Forceps..... 129 -132, S21, S23 -S24  
 Vitreoretinal Forceps 20 gauge..... 130, 131  
 Vitreoretinal Forceps 23 gauge..... 132  
 Vitreoretinal Forceps 25 gauge..... 132  
 Vitreoretinal Forceps, A. Mueller..... 130  
 Vitreoretinal Forceps, Naito..... 130, 133  
 Vitreoretinal Forceps, Reimann..... 129  
 Vitreoretinal Forceps, Tano..... 130, 132 -133, 219, S21, S23 -S24  
 Vitreoretinal Scissors..... 95 -96, S21, S23 -S24  
 Vitreoretinal Scissors 20 gauge..... 95

## KEYWORD ..... PAGE

Vitreoretinal Scissors 23 gauge.....	96
Vitreoretinal Scissors 25 gauge.....	96
Vitreoretinal Scissors, Heimann.....	95-96,
.....S21, S23-S24	
Vitreoretinal Scissors, Kroll.....	95
Vitreoretinal Scissors, Naito.....	95
Vitreoretinal Scissors, Roider.....	95
Vitreous Cutter.....	222

**W**

Wire Loop.....	88
----------------	----

NAME ..... PAGE

**A**

Agarwal..... 152  
 Akahoshi..... 120-21, 154, S3  
 Althaus / Cartsburg..... 202, S11  
 American Model..... 38  
 Amon..... 159  
 A. Mueller..... 130  
 Anel..... 189, S17  
 Anis..... 160  
 Arlt..... 161, S2, S4  
 Arruga..... 144  
 Auffarth..... 115, S3, S5  
 Axenfeld..... 37, 52, S15-S17  
 Ayer..... 134

**B**

Backhaus..... 136  
 Bangerter..... 23, 107, 126, 166, 190,  
 .....S14, S18-S19  
 Barraquer..... 15-19, 87, 101, 104, 109,  
 139-141, 145, S2-S4, S9-S10, S12-S15, S19  
 Barraquer Frankfurt Model..... 16  
 Barraquer-Oosterhuis..... 18  
 Barraquer-Troutman..... 140  
 Bartl..... 22  
 Bartz-Schmidt..... 175, S21  
 Bauer..... 57  
 Beer..... 101  
 Behrens-Baumann..... 162  
 Berke..... , 134  
 Best..... 69  
 Beyer..... 75  
 Binkhorst..... 163, 194  
 Blum..... 170, S7  
 Bonn Model..... 63, 90, 92, 106, 110-111,  
 .....158, 172, 174, 190, 191, 194, S2-S4, S9,  
 .....S12-S13, S15, S19, S21, S23-S24  
 Bopp..... 191, S10  
 Bowman..... 185, S17  
 Boynton..... 144  
 Braunstein..... 43  
 Brauweiler..... 85, 196, 198, 200, 201  
 Bremen Model..... 156  
 Breyer..... 169, 170, 171, S5, S8  
 Bunge..... 52, S14  
 Buratto..... 119, S7, S8  
 Burk..... 193  
 Busse..... 192

**C**

Castroviejo..... 23, 43, 81, 83, 103, 126, 142,  
 .....145, 163, 164, S2-S3, S9, S12-S19,  
 .....S21, S23-S24

NAME ..... PAGE

Cauer..... 134  
 Chang..... 210  
 Chansue..... 169-170, S8  
 Chayet..... 45, S7  
 Cibis..... 245  
 Citelli..... 75  
 Cook..... 23-24, S13-S14  
 Cranz..... 191, S3, S13  
 Cueppers..... 42, 172, S18

**D**

Dardenne..... 65, 107, 157, S2  
 D. D. Koch..... 159  
 D.D. Koch - T. Kohnen..... 198, 199  
 Desmarres..... 35-36, 134, S13-S16, S18  
 Dick..... 26, 122, 169, 202, S5  
 Dieffenbach..... 136, S2, S18-S19, S21, S23-S24  
 Dithmar..... 66  
 Doden..... 121, S2, S4  
 Draeger..... 102, S16, S17-S18, S21, S23-S24  
 Drysdale..... 155  
 Duisburg Model..... 209, S21  
 Duncker..... 42, S9

**E**

Elsa..... 243  
 Elschnig..... 126, 164  
 Elze..... 112  
 Engels..... 44, 159  
 Essen Model..... 127, 166

**F**

Fechner..... 121  
 Fine..... 82, 149-150, S7-S8  
 Fine-Thornton..... 149-150, S7-S8  
 Fink..... 44, S18  
 Flieringa..... 150, S9  
 Foerster..... 65, 102  
 Franceschetti..... 69  
 Frankfurt Model..... 16, 156, 158, 165, 192,  
 .....225, S2, S12-S13  
 Freiburg Model..... 102  
 Friedmann..... 242, S17  
 Fronimopoulos..... 44, S12

**G**

Gaskin..... 108, S4  
 Gass..... 77  
 Gerten..... 46, 117, S6, S11  
 Giessen Model..... 36, 44, 167, 183, S17  
 Goldstein..... 38  
 Gradle..... 101

NAME ..... PAGE

Graefe..... 93, 109, 173, S13-S14, S16, S18-S19  
 Grehn..... 76, S12  
 Greite..... 196  
 Grene..... 45  
 Guell..... 170  
 Guthrie..... 38, S16

**H**

Haefliger..... 152  
 Halstead..... 135, S2, S9, S12-S14,  
 .....S17-S19, S21, S23-S24  
 Hamburg Model..... 63, 69, 101, 162,  
 .....173, 210, S19  
 Hansen..... 65  
 Harms..... 186, 245, S12  
 Hartmann..... 135, S16, S21, S23, S24  
 Hattenbach..... 86, 108, 117, 143, 149, 175,  
 .....180, 219, 221, 264, S4, S6, S21, S23  
 Hattenbach / Nikolic..... 221, S23  
 Hebra..... 52  
 Heidelberg Model..... 109, 111, 144, 211, 242,  
 S17  
 Heimann..... 95-97, 128, S21, S23-S24  
 Hennig / Friedrich..... 155  
 Henry..... 101  
 Hess-Engelking..... 112  
 Hirschmann..... 157  
 Hoffer..... 41  
 Hoffmann..... 169, S5  
 Homburg Model..... 48  
 H.-R. Koch..... 17, 85, 88, 114-116, 124,  
 .....196, 200, S4  
 Hunold..... 205

**I**

Ikeda..... 116, 116  
 Inamura..... 115

**J**

Jacobi..... 156, 193, S9, S12  
 Jaeger..... 36, S15, S16  
 Jameson..... 174, S13, S15, S21, S23-S24  
 Japan Model..... 85, 116, S5  
 Juenemann..... 186, 190, 265, S17

**K**

Kalt..... 143  
 Kammann..... 29  
 Kampik..... 115, 207  
 Katzin..... 81, S9, S10  
 Kaufmann..... 102  
 Keerl..... 198

NAME .....	PAGE	NAME .....	PAGE	NAME .....	PAGE
Kellnar.....	184	Meyhoefer.....	51, S15-S16	Schaedel.....	136, S12, S19, S21, S23-S24
Kelly.....	76, S12	Meyhoeffer.....	S15	Schioetz.....	48, S12
Kelman-McPherson.....	108, S8	Miyoshi.....	151	Schmack.....	198, 199
Kerrison.....	75, S17	Mohr.....	77	Schmidt-Mumm.....	69, S12
Kershner.....	25, S9, S14, S19, S21, S23-S24	Morcher.....	241, S4	Schocket.....	180, S15
Kilp.....	244, S21, S23-S24	Morris-Kroll.....	175	Schott.....	31, 32
Kirchhof.....	229	Mueller.....	38, 130, 194, S17	Scott.....	46, S6
Klein.....	208	Muenster Model.....	172, S17	Sekundo.....	123, 160
Klöckner.....	193	Munich Model.....	103	Shaaf.....	101, S13, S15
Knorz.....	26, 118, S7, S8	Murdock.....	24-25	Shepard.....	122
Koch-Kohnen.....	S3, S5	<b>N</b>		Simcoe.....	194, 226, S2
Koga / Noda.....	28	Nagahara.....	152-154, S3, S5	Sinskey.....	156, 171-172, S2-S4
Kohnen.....	154, 172, 198	Nagata.....	193	Snellen.....	161
Kratz.....	17-19, 195, 226, S2	Naito.....	95, 97, 130, 133	Snyder-Osher.....	88, 125, S4, S6
Kratz-Barraquer.....	17, 19	Noda.....	27, 28, 29	Solomon.....	26
Krefeld Model.....	102	Noyes.....	86	Spaleck.....	123
Kreissig.....	179	<b>O</b>		Spencer.....	92
Kroll.....	95, 97, 175	Ohno.....	17	Spirig.....	158, 161, 192
Krumeich.....	42, 186, 197, S10	Örk Linz Model.....	71	Steinmetz.....	87, 158, S4
Kuhn.....	246, S21	Osher.....	43, 86, 88, 125, S4, S6	Stevens.....	89, S3, S13-S14, S16-S19, S21, S23-S24
Kuhnt.....	64, S9, S14, S16	<b>P</b>		Strobel.....	125
Kyu.....	195	Papst.....	195, 205, 264	Swiss Model.....	111, 112
<b>L</b>		Paulfrique.....	64, 105, S9, S14, S21, S23-S24	Szurman.....	64, 71, 105, 117, 168, 203, 223, S11
Lambert.....	, S16, 134	Paulmann.....	27	<b>T</b>	
Landers.....	244	Peyman.....	244	Takeda.....	19
Laqua.....	179, 207, S19	Pfaeffl.....	118, 171, S7-S8	Tandogan.....	157
Lester.....	157	Pfaeffl-Breyer.....	171	Tano.....	130, 132-133, 219, S21, S23-S24
Lewicky.....	225	Pfennigwerth.....	127	Teping.....	195
Leyhecker.....	126	Ph. Jacobi.....	193, S12	Thomas Neuhann.....	19, 41-42, 70, 104, 112, 118, 151, 153-155, 167-168, 186, 202, S3, S5, S8-S11
Liebermann.....	25, 28, 154, S2-S3, S7-S8, S12	Plange.....	55, 56	Thornton.....	149-150, S7-S8
Liebermann-Tennant.....	25, 28, S2-S4, S7-S8, S10, S12-S13	Pretori.....	21	T. Kohnen.....	122, 154, 198
Lindstrom.....	42	<b>R</b>		T. Neuhann.....	123
Lohmann.....	243, S7, 64	Rau.....	168	Tobias Neuhann.....	44, 116-117, 152
Lordan.....	134, S16	Reimann.....	129	Tolentino.....	244
Lu.....	45, S7	Remky.....	105, 125, S2, S11-S12, S19	Troeltsch.....	127
Lucke.....	175, 179	Rentsch.....	156, 159-160, 194, S6, S10	Troutman.....	81, 140, 145, S2
Lund.....	158	R. Koch.....	201, 202	Tuebingen Model.....	84, 106, 192, 225, S2-S3, S10, S12-S13, S16-S19, S21, S23-S24
Luntz-Dodick.....	76, S12	Rohrschneider.....	144	<b>V</b>	
<b>M</b>		Roider.....	95, 210	Vannas.....	84-85, S2-S4, S9-S10, S13, S15, S21, S23-S24
Machemer.....	244	Rollet.....	37	Vogt.....	44, S18
Mackensen.....	82, 186	Rupal Shah.....	119, S8	Völcker.....	151
Mainz Model.....	155	Rycroft.....	225	von Barsewisch.....	121
Malbran.....	174, S18-S19	<b>S</b>		<b>W</b>	
Maloney.....	45, S9	Sattler.....	127, S18-S19	Walser.....	245, S14
Masket.....	113	Sauer.....	19		
Maus.....	30	Sautter.....	81, 162, 192, 225, S3-S5, S9, S12		
Mead.....	242, S17				
Mellinger.....	20				
Mellinger-Beard.....	20				
Mendez.....	45-46, S7				
Meyer-Schwickerath.....	180				

NAME ..... PAGE

Watzke.....	127, S19
W. Bauer.....	196
Weber.....	161, 210, S21
Wecker.....	86, 87, 165
Weiss.....	21, 22
Wells.....	167, S14
West.....	243
Westcott.....	89, S2, S9, S12-S13, S16, ..... S18-S19, S21, S23-S24
Wilder.....	183, S15, S17
Wright.....	243

**Y**

Yae.....	85, S5
Yörük.....	117

**Z**

Zirm.....	30, 151, 157, 167, 197, S7-S8
Zuerich Model.....	104





**Geuder**<sup>®</sup>  
Precision made in Germany

GEUDER AG  
Hertzstrasse 4  
69126 Heidelberg  
Germany

Phone: +49 6221 3066  
Fax: +49 6221 303122  
info@geuder.de  
www.geuder.com